



DI-4730
*High Speed Industrial Data Acquisition System
with 8 High Voltage Isolated Channels, Programmable Gain,
Expandability with ChannelStretch™, and Stand-alone Capability*

User's Manual
Manual Revision B

Copyright © 2021 by DATAQ Instruments, Inc. The Information contained herein is the exclusive property of DATAQ Instruments, Inc., except as otherwise indicated and shall not be reproduced, transmitted, transcribed, stored in a retrieval system, or translated into any human or computer language, in any form or by any means, electronic, mechanical, magnetic, optical, chemical, manual, or otherwise without expressed written authorization from the company. The distribution of this material outside the company may occur only as authorized by the company in writing.

DATAQ Instruments' hardware and software products are not designed to be used in the diagnosis and treatment of humans, nor are they to be used as critical components in any life-support systems whose failure to perform can reasonably be expected to cause significant injury to humans.

DATAQ, the DATAQ logo, and WINDAQ are registered trademarks of DATAQ Instruments, Inc. All rights reserved.



DATAQ Instruments, Inc.
241 Springside Drive
Akron, Ohio 44333 U.S.A.
Telephone: 330-668-1444
Fax: 330-666-5434

Designed and manufactured in the
United States of America

Warranty and Service Policy

Product Warranty

DATAQ Instruments, Inc. warrants that this hardware will be free from defects in materials and workmanship under normal use and service for a period of 1 year from the date of shipment. DATAQ Instruments' obligations under this warranty shall not arise until the defective material is shipped freight prepaid to DATAQ Instruments. The only responsibility of DATAQ Instruments under this warranty is to repair or replace, at its discretion and on a free of charge basis, the defective material.

This warranty does not extend to products that have been repaired or altered by persons other than DATAQ Instruments employees, or products that have been subjected to misuse, neglect, improper installation, or accident.

DATAQ Instruments shall have no liability for incidental or consequential damages of any kind arising out of the sale, installation, or use of its products.

Service Policy

1. All products returned to DATAQ Instruments for service, regardless of warranty status, must be on a freight-prepaid basis.
2. DATAQ Instruments will repair or replace any defective product within 5 days of its receipt.
3. For in-warranty repairs, DATAQ Instruments will return repaired items to the buyer freight prepaid. Out of warranty repairs will be returned with freight prepaid and added to the service invoice.

Table of Contents

Warranty and Service Policy	iii
1. Introduction	1
Features	1
Analog Inputs	1
Digital Inputs	2
Software	2
WINDAQ® Recording and Playback Software	2
Help	2
2. Specifications	3
3. Installation	7
Install WinDaq Software	7
Connect the Instrument to Your Computer	8
USB Installation	8
Ethernet Installation	8
4. Controls, Indicators, and Connections	11
Front Panel	11
Analog Inputs	11
Low-pass Filter	12
Resolution as a Function of Sample Rate	13
Rear Panel	14
“Digital Inputs”	14
“Status” LED	14
“USB Drive”	15
“USB” Mini-B USB Connection	15
“Ethernet” port	15
Control “Button” Operations	16
Record Data to USB Thumb Drive	16
Stop Recording to USB Thumb Drive	16
Fix Errors	16
Switching between LibUSB and CDC Modes	16
Save Ethernet and Stand-alone configuration to Thumb Drive	16
Apply Ethernet and Stand-alone Configuration to Device	17
Ground Lug	17
Power Input Jack	17
Power Switch	17
Connecting Digital Input Signal Leads	17
Digital Ports	18
WinDaq Remote Events (D0 Event)	19
WinDaq Remote Storage (D1 Record)	20
WinDaq Rate (D2 Rate)	21
WinDaq Counter (D3 Count)	22
General Purpose Digital Inputs	24
WinDaq Dashboard	25
ChannelStretch™	26
Connection	27

Channel Selection	28
5. Unlock WinDaq and Stand-alone Data Logging	33
6. Dimensional Drawing	35

1. Introduction

This manual contains information designed to familiarize you with the features and functions of the DI-4730 High Voltage data logger and data acquisition system.

Features

The DI-4730 has the following features:

- 8 fixed isolated high voltage ($\pm 1000\text{V}$ Full Scale) differential inputs with software-programmable input ranges of $\pm 10\text{mV}$, $\pm 100\text{mV}$, $\pm 1\text{V}$, $\pm 10\text{V}$, $\pm 100\text{V}$ and $\pm 1000\text{V}$ per channel
- 7 digital inputs protected to $+30\text{V}$
- Up to 16-bit measurement resolution (dependent on sample rate)
- Built-in USB, Ethernet, and Power over Ethernet (PoE) interfaces
- Up to 160 kHz maximum throughput sampling rate
- Adaptable low-pass filter per channel - corner frequency set as a function of sampling rate
- A multi-purpose push-button for WINDAQ remote events and start/stop recording
- Multi-color LED indication for easy notification of device status
- Counter channel.
- Frequency channel.
- Free WinDaq data acquisition recording software. Purchase unlock code WinDaq/Pro for ChannelStretch and Stand-alone data recording to removable flash memory.
- Stand-alone option allows the user to configure a recording session through their PC then record data in the field to removable flash memory via the USB drive port (without being connected to their PC). Stand-alone data logging requires Unlock code to record more than 1 channel to removable flash memory.*
- ChannelStretch™ Technology allows you to sync up to sixteen DI-4730, DI-4108, DI-4208, or DI-4718B instruments in any combination with a total throughput of 480kHz or more (requires unlock code for each device).*
- Fully documented instrument protocol for programming the device in operating systems other than Windows.*

*WinDaq/Pro required per device to use ChannelStretch™ when using WinDaq software. These restrictions do not apply when programming the device yourself. This unlock code is also required to record more than a single channel to removable USB thumb drive.

Analog Inputs

The DI-4730 features eight differential channel banana plug inputs located on the front panel for easy connection and operation. Gain measurement ranges of $\pm 10\text{mV}$, $\pm 100\text{mV}$, $\pm 1\text{V}$, $\pm 10\text{V}$, $\pm 100\text{V}$ and $\pm 1000\text{V}$ are programmable on a per channel basis.

Utilize the functionality of WINDAQ software to experience all the features built in to these cost-effective industrial units. An Unlock Code is required to synchronize and record multiple units when using WinDaq software. There are no restrictions when programming the instruments yourself.

Digital Inputs

The DI-4730 contains seven digital inputs that may be used as a general-purpose digital input or for a specific function as designated on the device. Digital port D0 may be used for WinDaq Events; Digital port D1 may be used for WinDaq remote Start/Stop; Digital port D2 may be used for rate measurements; Digital port D3 may be used for counts; Digital ports D4 and D5 are general purpose digital input ports. D6 may be used as an external trigger in WinDaq software with the “Use External Clock” preference. **Please Note:** *Digital outputs are not available on this device.*

Software

All software required to record and playback waveforms is included with the purchase of any DI-4730 data acquisition system on the included thumb drive or via download at run.dataq.com. Use the WinDaq Dashboard to access WinDaq Acquisition software or to setup the stand-alone configuration.

WINDAQ® Recording and Playback Software

WINDAQ Acquisition and WINDAQ Waveform Browser allow you to record and playback data acquired through your instrument. WINDAQ software is an invaluable resource to record and analyze your data and is available for free from our web site (www.dataq.com).

WINDAQ Data Acquisition software (free) can be used to record waveforms directly and continuously to disk while monitoring a real time display of the waveforms on-screen. It operates, displays, and records data in real time when connected to your PC. An optional unlock code (WinDaq/Pro) is available to sync multiple units into a single WinDaq file.

WINDAQ Waveform Browser playback software (also known as “WWB”) offers an easy way to review and analyze acquired waveforms. A built-in data file translator allows the user to display multiple waveforms acquired by WINDAQ Acquisition software or any of a wide range of data acquisition packages. The software’s disk-streaming design allows data files of any length to be graphically displayed rapidly, in normal or reverse time directions. Seven standard cursor-based measurements, frequency domain, and statistical analysis functions help simplify waveform analysis and interpretation. WINDAQ Waveform Browser is free and installed when installing WINDAQ Software.

Help

All WINDAQ software utilizes context-sensitive help. Help may be accessed through the Help menu or by pressing the F1 key with any pull-down menu item selected. This will take you directly to the Help topic most relevant to that particular function or feature. Help topics discuss in detail each function available in the software.

2. Specifications

Analog Inputs

Number of Channels:	8
Channel Configuration:	Differential
Measurement range per channel:	Programmable $\pm 10\text{mV}$, $\pm 100\text{mV}$, $\pm 1\text{V}$, $\pm 10\text{V}$, $\pm 100\text{V}$, $\pm 1000\text{V}$
Isolation:	$\pm 1000\text{V}$ input-to-output and channel-to-channel
Max normal mode voltage (V_{NM}):	800VDC or peak AC
Max common mode voltage (V_{CM}):	1000VDC or peak AC
Max Input without Damage:	$\pm 1000\text{VDC}$ or Peak AC ($\pm 1000\text{V}$ and $\pm 100\text{V}$ Ranges all other ranges with fuse protection)
Common Mode Rejection:	100dB min @ DC to 60Hz
Accuracy:	0.25% of full scale range $\pm 100\mu\text{V}$ N.A. for 10mV range
Input Impedance:	10M Ω for all ranges
Analog frequency response (each ch):	± 1000 , 100, 10, 1V: -3 db @ 5.0 kHz $\pm 100\text{mV}$: -3 db @ 4.50 kHz
Channel-to-channel crosstalk rejection:	-75 dB @100kHz into 100 Ω unbalanced
Analog input connector type:	Safety banana socket - 1 pair per channel

ADC Characteristics

Resolution:	12- to 16-bit Above zero ADC counts: 2,047 to 32,767 Below zero ADC counts: 2,048 to 32,768
Max. throughput sample rate:	Standard: 160 kHz Stand-alone: 20 kHz to 160 kHz (dependent on flash memory)
Min. throughput sample rate:	Standard: 20 Hz (2.2 samples per hour with WinDaq) Stand-alone: 0.0017 Hz
Sample rate timing accuracy:	100 ppm

Digital Inputs

Number of Ports:	7
Configuration:	Input
Threshold levels:	TTL compatible
Absolute maximum applied voltage (V):	25 V dc

Reserved Digital Inputs

Port 1:	WINDAQ remote events
Port 2:	WINDAQ remote start/stop
Port 3:	Rate input
Port 4:	Count input

Count/Rate/Digital Inputs

Internal pull-up value:	4.7 k Ω
Input high voltage threshold:	2.4 V
Input low voltage threshold:	0.8 V
Terminal count:	65,535
Maximum rate frequency:	50 KHz with one enabled channel 20 KHz with 2-4 enabled channels 10 KHz with 5-7 enabled channels
Minimum rate frequency:	0.5 Hz
Maximum count frequency:	50 kHz

Ethernet Interface

Type:	10/100Base-T
Connector:	RJ-45
Protocol:	TCP/IP
Server Type:	DHCP or Fixed IP

Removable Memory

Type:	MLC, pSLC, or SLC flash memory (with USB SD card reader); USB thumb drive
Required Format:	FAT32

Indicators and Connections - Rear Panel

USB port:	USB 2.0 (mini-B style connector) PC communications
USB Drive (A-type Connector):	USB drive for Stand-alone data logging Cannot be used concurrently with the USB interface
Ethernet port:	RJ-45 10/100Base-T; PoE supported
Digital I/O connections:	One 16-position screw terminal block
Button:	Multi-function control (Start, Stop, Save Configuration, Apply Configuration)
Status LED:	One multicolor LED for status indication

Indicators and Connections - Front Panel

Analog Input Connections:	16 insulated banana jacks (2 per channel)
---------------------------	---

USB ChannelStretch™ Operation

Total Max Units:	16
Max Channel Count:	128 Analog, 112 Digital
Max Throughput:	\geq 480 kHz (higher speeds may result in data loss)
Channel skew between any 2 units:	10 μ S, typical

Synchronization Conditions: Syncs with any combination of DI-4108, DI-4208, DI-4718B, and DI-4730 USB instruments.
All synced instruments must operate at the same sample rate per channel, regardless of channel number, type, or range.
All instruments must be connected to the same USB controller. The use of USB hubs are recommended to meet this requirement.

Ethernet ChannelStretch™ Operation

Total Max Units: 16
Max Channel Count: 128 Analog, 112 Digital
Max Throughput: ≥ 50 kHz (higher speeds may result in data loss)
Channel skew between any 2 units: 100 μ S, typical
Synchronization Conditions: Syncs with any combination of DI-4108, DI-4208, DI-4718B, and DI-4730 Ethernet instruments.
For most accurate synchronization, all instruments should be connected to the same Ethernet switch.

Power

Voltage: 9-36 VDC
Power Consumption: 14 Watts

Environmental

Operating Temperature: 0°C to 50°C (32°F to 122°F)
Operating Humidity: 0 to 90% non-condensing
Storage Temperature: -20°C to 60°C (-4°F to 140°F)
Storage Humidity: 0 to 90% non-condensing

Physical Characteristics

Enclosure: Aluminum base with steel wrap-around
Mounting: Desktop; Bracketed
Dimensions: 7.29"W \times 9"L \times 1.52"H
(18.5D \times 22.86W \times 3.86H cm.)
Weight: approx 3 lbs

Software Support

WINDAQ software: OS support: Check online at <http://www.dataq.com/products/windaq/windows-compatibility/>
Programming: [Instrument Protocol](#)

3. Installation

The following items are included with each DI-4730 Data Acquisition System. Verify that you have the following:

- A DI-4730 data acquisition instrument.
- 6-foot USB cable.
- 5-foot Ethernet cable.
- AC power supply.
- A DATAQ Instruments screwdriver for digital signal lead connections.
- A USB flash drive with WinDaq software and an NIST-traceable calibration certificate. Can also be used for stand-alone data logging.

If an item is missing or damaged, call DATAQ Instruments at 330-668-1444. We will guide you through the appropriate steps for replacing missing or damaged items. Save the original packing material in the unlikely event that your unit must, for any reason, be sent back to DATAQ Instruments.

Install WINDAQ Software

All software for the DI-4730 can be installed via a download-able executable directly from the DATAQ Instruments web site. The software is also available on the provided USB flash drive.

1. Disconnect all DATAQ Instruments USB devices from your Computer.



2. Plug the USB flash drive (the USB flash drive is shipped installed on the instrument) into your computer's USB port or go to run.dataq.com to download the software.
3. Save the executable (Dataq Software Suite Web Setup.exe) to your local hard drive.
4. Double-click on the executable to extract the program and begin software installation.
5. Follow the on-screen prompts and enter all required information.
6. Software installation is complete - you will now see a "Successful Installation" box - click **OK** to exit WINDAQ Installation.

You can now plug the device(s) into your PC. Click on the appropriate program group (specified above — default is Start > Programs > WINDAQ) and click on “WinDaq Dashboard” to access WINDAQ software.

Connect the Instrument to Your Computer

All DI-4730 instruments can be installed, configured, and operated as a USB device or an Ethernet/PoE device. The WinDaq Dashboard application will automatically detect the communications interface being used.

USB Installation

1. Apply power to the DI-4730.
2. Connect one end of the provided USB cable to the “USB” port on the DI-4730.
3. Connect the other end of the provided USB cable to a USB port on your PC.
4. Open the WinDaq Dashboard application.

The device appears on the list of available devices in the dashboard utility. Run WinDaq Data Acquisition software, set the device clock, change ethernet settings, and configure and record data to a thumb drive with the menu items available in the dashboard.

Ethernet Installation

All DI-4730 instruments are shipped DHCP-enabled. We recommend you setup a DHCP reservation on your network for your data acquisition applications.

1. Find the MAC address of your DI-4730. The device MAC address is printed on the bottom label of the device:

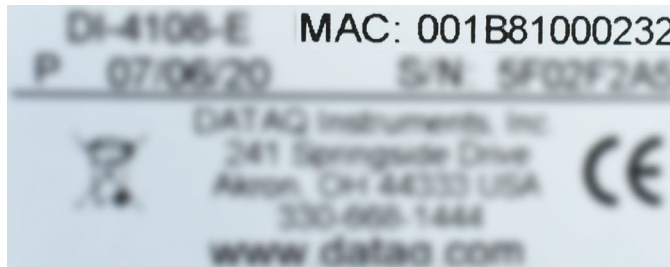

2. Login to your Router and ensure the DHCP server is enabled.
3. Access the DHCP Reservations, Static DHCP, or IP Allocations page/table.
4. Enter the MAC address of your device in the table (you may need to enter colons for proper format - for example, 001B1000232 may need to be 00:1B:81:00:02:32), enter an unused IP address in the table row (or allow your router to select it for you if possible), and Select/Enable for DHCP Reservation.
5. Save your router settings.
6. Connect your DI-4730 unit into your Local Area Network using the supplied Ethernet Cable.
7. Apply Power to the device if required. PoE devices can derive power from a PoE switch.

Open the WinDaq Dashboard utility to access device settings and run WinDaq Data Acquisition software. The WinDaq Dashboard allows you to set the device clock, change your Ethernet settings (DHCP/Static), setup and record to a thumb drive, access files on the thumb drive, and view live data.

If your device is not discovered in WinDaq Dashboard, connect it to your computer via the USB cable and configure the Ethernet settings to allow for DHCP.

If the device is available in WinDaq Dashboard but you cannot run WinDaq Acquisition software, you may have the application blocked in Windows Firewall. See <https://www.dataq.com/blog/data-acquisition-software/is-the-windows-defender-firewall-blocking-windaq/> for more information and resolution.

4. Controls, Indicators, and Connections

Front Panel

The front panel of the DI-4730 contains 16 banana jacks for safe connection of analog input signals.

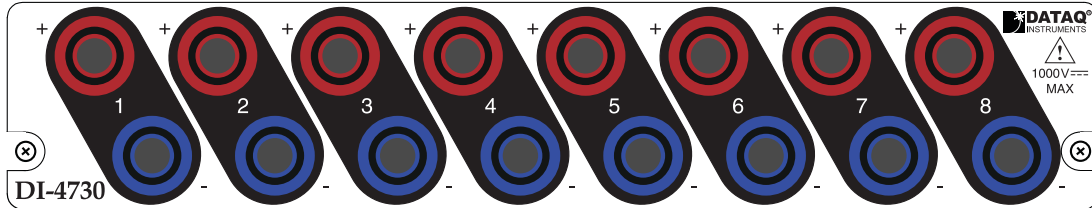

Analog Inputs

All analog input signal connections are made to the banana plugs. Each terminal is clearly labeled to correspond with the physical channel. Each analog input measures $\pm 10\text{mV}$, $\pm 100\text{mV}$, $\pm 1\text{V}$, $\pm 10\text{V}$, $\pm 100\text{V}$ or $\pm 1000\text{V}$ (programmable).

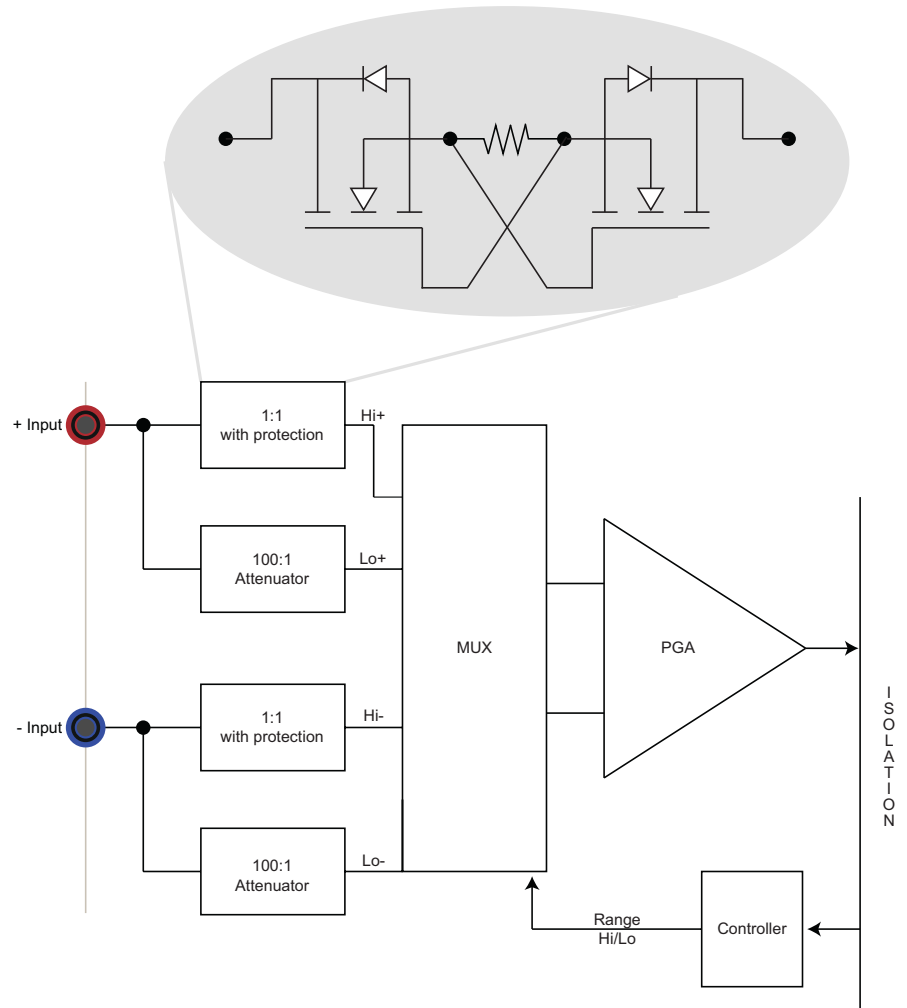

Use the following diagram to connect Analog Input Channel 1.

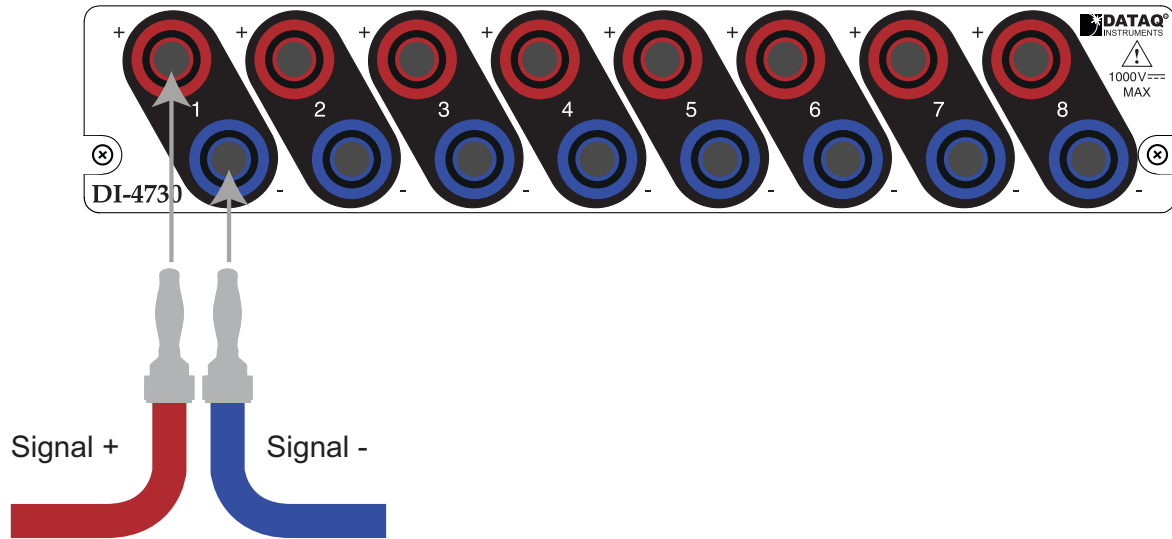

Specify a full scale range for the channel in the menu item **Edit > Channel Settings**.

Scroll through all enabled channels with the **Next** and **Previous** buttons.

Low-pass Filter

Each analog channel employs a low-pass filter with automatic corner frequency selection. The filter is a CIC (cascaded integrator comb) type that uses as many as 512 samples per channel to calculate in real time as data is acquired. Filter response is optimized when sampling frequency is set to ten times the highest frequency of interest.

Typical Low-pass Filter Frequency Response

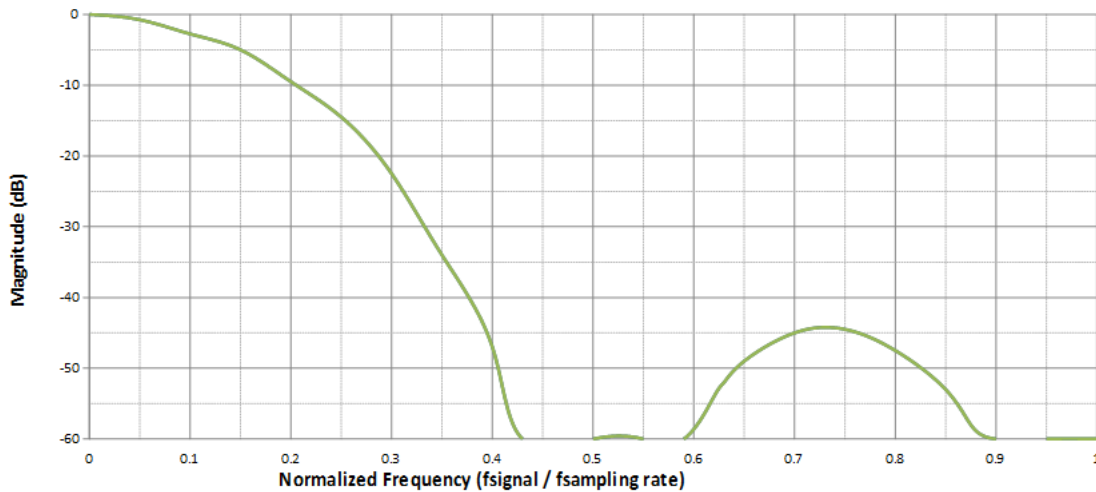

The DI-4730 calculates its own Last Point, Maximum, Minimum, and Filter data making it available at the programming level. Acquisition methods “RMS” and “Frequency” are permanently disabled for the DI-4730, as are Input Types “Nonlinear” and “Thermocouple” and selections for “Unipolar” and “Fahrenheit.”

Please Note: Last Point, Maximum, and Minimum modes utilize only 12-bit data as the CIC filter is not used.

Resolution as a Function of Sample Rate

The resolution of the DI-44730 is a function of sample rate. The lower the sample rate the higher the resolution. ADC resolution (R) is a function of selected sample rate per channel (F), and the number of enabled analog channels (C):

$$R = \frac{\log\left(\frac{160000}{FC}\right)}{\log(4)} + 12$$

C	Enabled Channels
1	1
2	2
4	3-4
8	5-8

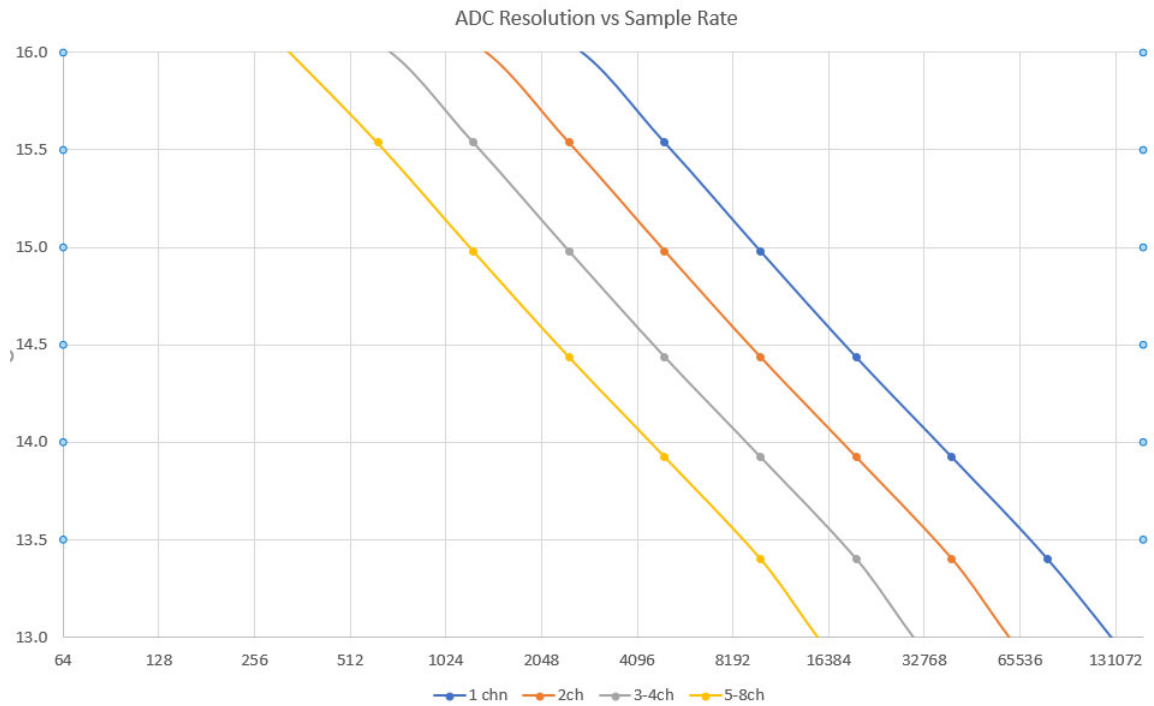

Rear Panel

The rear panel of the DI-4730 contains power, communications, and digital inputs.

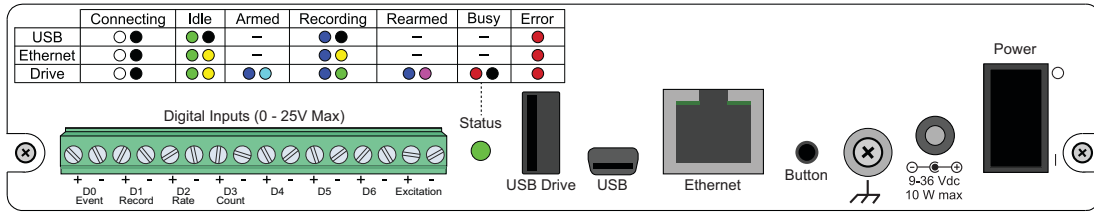

“Digital Inputs”

Refer to the following for Digital Input pinout:

D#: Digital port (0-6). Can also be used for specific WINDAQ functions (+25 Vmax).

D0 Event — WINDAQ Remote Event Marker (or general-purpose)

D1 Record — WINDAQ Remote Start/Stop (or general-purpose)

D2 Rate — Rate Input (or general-purpose)

D3 Count — Counter Input (or general-purpose)





D4 and D5 — General-purpose digital inputs









D6 Ext Trig — External Trigger (or general-purpose)

Excitation: +15V out. Max current = 67mA. Use these ports to power sensors as required.

“Status” LED

Indicates what mode the instrument is in. Use the chart on the top of the instrument for quick reference. Use the table below for a detailed description of each state as well as a description of some states not displayed on the label.

State	Mode	Description
 Blinking White	Connecting	The device is looking for a connection to your PC or USB thumb drive. It will check the USB interface first, then the Ethernet and USB thumb drive. Once a connection is established the device will enter Idle mode.
 Blinking Green	Idle USB Connected	The device is connected to and communicating with your PC through the USB port. The USB thumb drive and Ethernet port are not accessible.
 Blinking Green/ Yellow	Idle Ethernet or USB Drive Connected	The device is connected to and communicating with your PC through the Ethernet port or the device is in Stand-alone mode. The USB interface is not accessible.
 Blinking Blue	Acquiring Data to PC via USB Interface	WinDaq Acquisition Software is running and the device is acquiring data to your PC via the USB interface.

 Blinking Blue/ Yellow	Acquiring Data to PC via Ethernet Interface	WinDaq Acquisition Software is running and the device is acquiring data to your PC via the Ethernet interface.
 Blinking Blue/ Green	Recording Data to USB thumb Drive	The device is acquiring data and recording to your USB thumb drive. Do not remove power - power interruption could result in data file corruption.
 Blinking Blue/ Cyan	Armed USB thumb Drive is waiting for a trig- ger condition	The device is acquiring data and waiting for a trigger condition to begin recording to your USB thumb drive. Do not remove power or the USB thumb drive - either could result in data file corruption.
 Blinking Blue/ Cyan	Re-armed USB thumb Drive is waiting for a trig- ger condition	The device is acquiring data and waiting for another trigger condition to continue recording to your USB thumb drive. Do not remove power or the USB thumb drive - either could result in data file corruption.
 Blinking Red	Busy USB thumb Drive is busy	The device is reading from or writing to the USB thumb drive. Do not remove power or the USB thumb drive - either could result in data file corruption.
 Solid Red	Error	The device is unable to perform any operations. Cycle power or use the control button to resolve the error.
 Solid White	Button Pushed	The LED turns white to indicate the control button is engaged.
 Blinking Yellow	Idle USB connected in CDC mode	The device is connected to and communicating with your PC through the USB port in CDC mode. WinDaq software will not run. The USB thumb drive and Ethernet port are not accessible.

“USB Drive”

Allows you to record to any USB flash memory device with a USB A type connection. Not all flash memory is fast enough to record at higher sample rates. Use the provided USB flash drive for rates below 20,000 S/s Throughput. The mini-USB interface cannot be used in conjunction with the USB Drive.

“USB” Mini-B USB Connection

The USB interface port allows you to connect the instrument to your PC via USB cable. When in USB mode the Ethernet cable and USB thumb drive are inactive.

“Ethernet” port

The Ethernet interface port allows you to connect the instrument to your PC or network via Ethernet cable. When in Ethernet mode the USB connection is inactive. The port supports Power over Ethernet (PoE).

Control “Button” Operations

The Control Button can be used to stop or start recording data to the USB thumb drive when using the instrument as a stand-alone data logger. The Control Button can also be used to update firmware (contact support for instructions if/when required). The Control Button can also be used to create an instantaneous event marker when running WINDAQ Acquisition software.

Record Data to USB Thumb Drive

Record data to an installed USB thumb drive. The device must be in Idle mode and set for USB Drive (mode LED must be flashing Green/Yellow). After the button is pressed, the mode LED will flash Blue/Green or Blue/Cyan to indicate it is in a recording mode.

Stop Recording to USB Thumb Drive

Manually stop recording to the USB thumb drive (when the mode LED is flashing Blue/Green, Blue/Cyan, or Blue/Magenta). After the button is pressed the mode LED will flash Green/Yellow to indicate Idle.

Fix Errors

The Control Button can also be used to fix some common operating errors. When the instrument is in Error mode (mode LED is solid red), some action must be taken to fix the error before you can use it. Generally, the Control Button can be used to make the instrument operational again when in Error mode.

Switching between LibUSB and CDC Modes

The native communication mode of DI-4730 instruments is LibUSB but it can be switched to the USB CDC (Communication Device Class). CDC mode allows the USB port of DI-4730 devices to appear like a traditional RS-232 port, which is common across most operating systems and development languages. **Please note:** *LibUSB communication is required for WinDaq Acquisition software and programming with our .NET SDK. Only switch to CDC mode when writing your own programs at the protocol level (for example, Python applications).* Use the following sequence to switch your device to/from LibUSB/CDC modes:

1. Connect the device to your PC via the USB port.
2. Apply power to the device.
3. When mode LED stops blinking white and is in Idle mode, push and hold the Control button. This must be completed within five seconds after the device is in Idle mode.
4. When the mode LED turns red, release the Control button.
5. The Mode LED will flash white then indicate Idle in either LibUSB or CDC mode:
 - CDC mode: Blinking Yellow
 - LibUSB mode: Blinking Green

Save Ethernet and Stand-alone configuration to Thumb Drive

Save Ethernet settings and/or stand-alone configuration settings using the Control Button. Ethernet and Stand-alone configurations can also be saved to the thumb drive via the Dashboard (preferred method). Device must be in Idle mode for Ethernet or USB thumb Drive (mode LED blinks green/yellow). The Unlock Code must be purchased for your device in order to save the stand-alone configuration.

1. Format your USB thumb drive using your PC.
2. Confirm device is in Idle mode for USB Flash Drive (mode LED blinks Green/Yellow).
3. Push and hold the Control button.

4. Plug the formatted (empty) thumb drive into the device (Drive) while holding the button in.
5. Release the button when the mode LED changes to Red/Black.
6. The device will read and load the configuration files to the thumb drive and revert to Idle mode when complete.

Configuration files include network.json (Ethernet configuration) and config.whd or config.whc (WinDaq configuration). Use the WinDaq Dashboard to create configuration files.

Apply Ethernet and Stand-alone Configuration to Device

Load Ethernet settings or stand-alone configuration settings using the Control Button. Ethernet and Stand-alone configurations can also be applied via the Dashboard (preferred method). Device must be in Idle mode for Ethernet or USB thumb Drive (mode LED blinks green/yellow). The Unlock Code must be purchased for your device in order to apply the stand-alone configuration.

1. Save configuration files to your USB thumb drive.
2. Confirm device is in Idle mode for USB Flash Drive (mode LED blinks Green/Yellow).
3. Push and hold the Control button.
4. Plug the thumb drive into the device (Drive) while holding the button in.
5. Release the button when the mode LED changes to Red/Black.
6. The device will read and load the configuration files to the device and revert to Idle mode when complete.

Configuration files include network.json (Ethernet configuration) and config.whd or config.whc (WinDaq configuration). Use the WinDaq Dashboard to create configuration files.

Ground Lug



This ground lug should always be connected to a solid chassis or earth ground. This connection is mandatory when connecting signal leads.

Power Input Jack

Power must be applied with the included power adapter or with an alternate appropriate source (9-36VDC, 15 watts max). Alternately you may power the device with a Power over Ethernet (PoE) switch.

Power Switch

Power the DI-4730 on/off using the power switch.

Connecting Digital Input Signal Leads

Connect signal leads to the DI-4730 digital inputs:

1. Insert the stripped end of a signal lead into the desired terminal directly under the screw.
2. Tighten the pressure flap by rotating the screw clockwise with a small screwdriver. Make sure that the pressure flap tightens only against the signal wire and not the wire insulation. Do not over-tighten.

3. Tug gently on the signal lead to ensure that it is firmly secured.

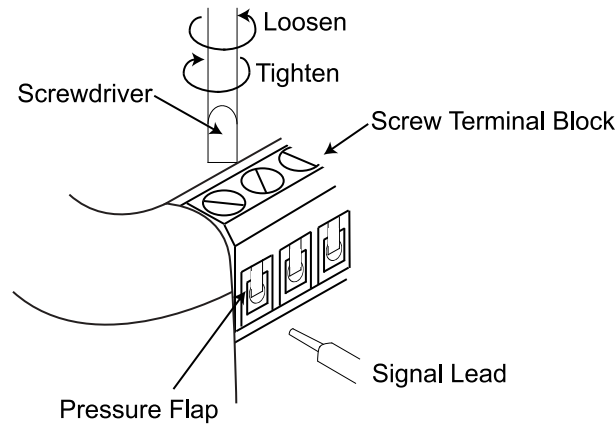

When an input signal is connected and WINDAQ Acquisition software is run, WINDAQ's real time display immediately reveals the input waveform on your computer's monitor.

Digital Ports

The DI-4730 contains 7 general-purpose digital input ports. Many of the ports also provide specific functionality in WINDAQ or a third-party program.

- D0 Event is for WINDAQ Remote Events. This bit inserts an event marker in your data.
- D1 Record is for WINDAQ Remote Storage. This bit can be programmed to begin recording data.
- D2 Rate is for Rate measurements: 10Hz to 50kHz.
- D3 Count is for Counter/Timer measurements up to 65,536.
- D4, D5, and D6 are general-purpose digital inputs.

Equivalent Digital Circuit:

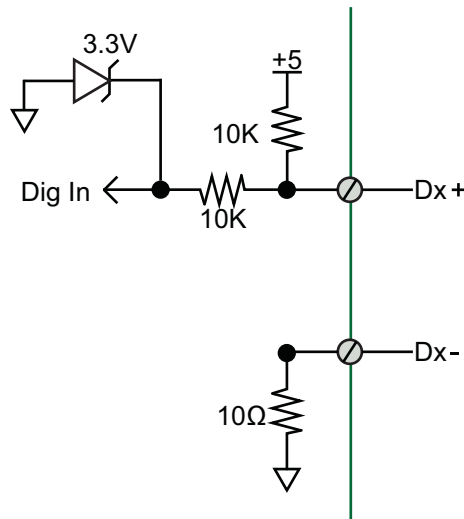

WINDAQ Remote Events (D0 Event)

To use a switch closure or TTL signal to record WINDAQ Event Markers, connect signal leads to the appropriate Remote Control Event terminals on the DI-4730 as shown below.

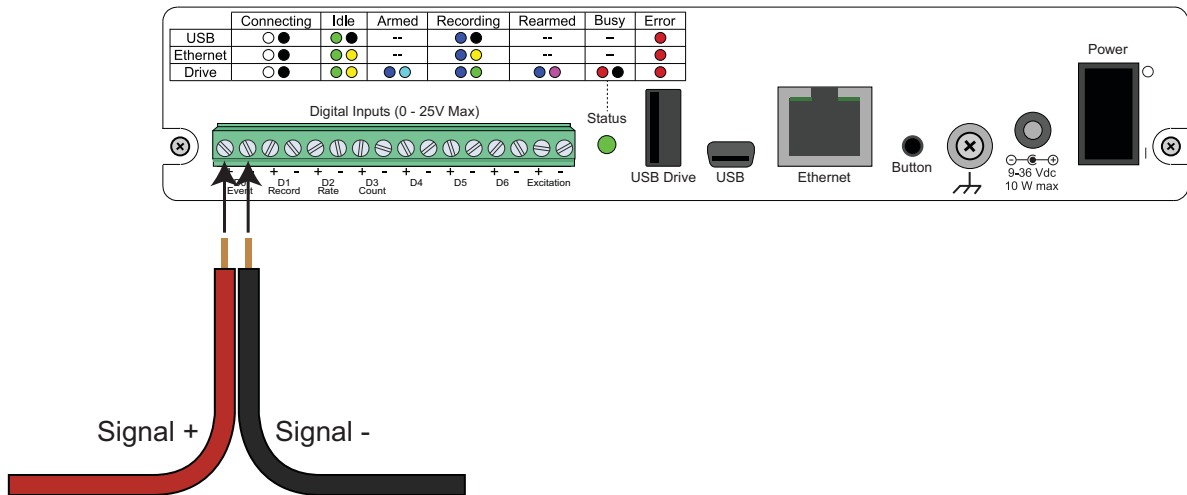

Once the switch closure or TTL signal is connected, activate Remote Events through WINDAQ Acquisition Software. Events may be automatically placed on the rising or falling edge of the trigger signal. Use the menu command **Options > Remote Events +** to set WINDAQ to place event markers on low-to-high transitions of the Event input. Use the menu command **Options > Remote Events -** to set WINDAQ to place event markers on high-to-low transitions of the Event input.

Event markers may also be placed in your data file manually by pressing the push button on the instrument. You must enable Remote Events in WINDAQ to use the button (use the menu command **Options > Remote Events + or Options > Remote Events -**).

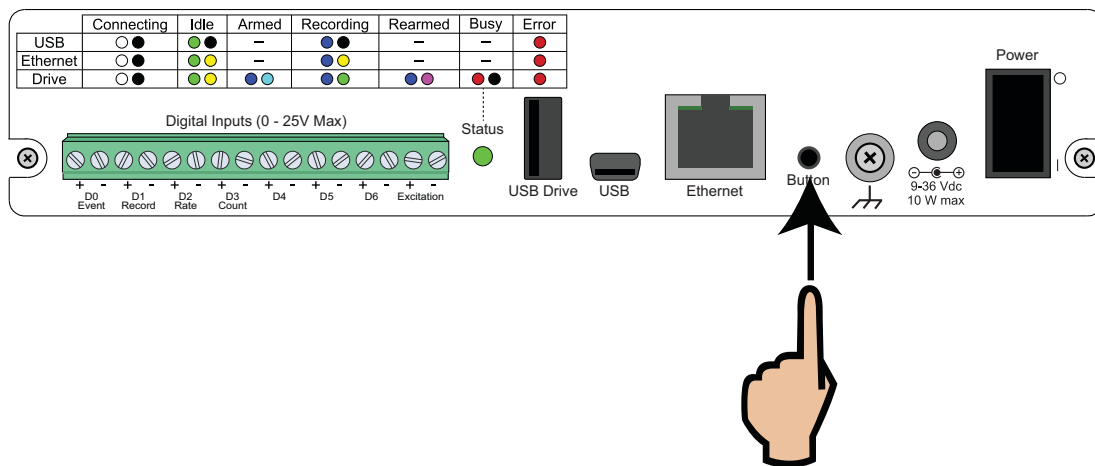

An example event marker in a WINDAQ data file is shown below.

Event Marker*

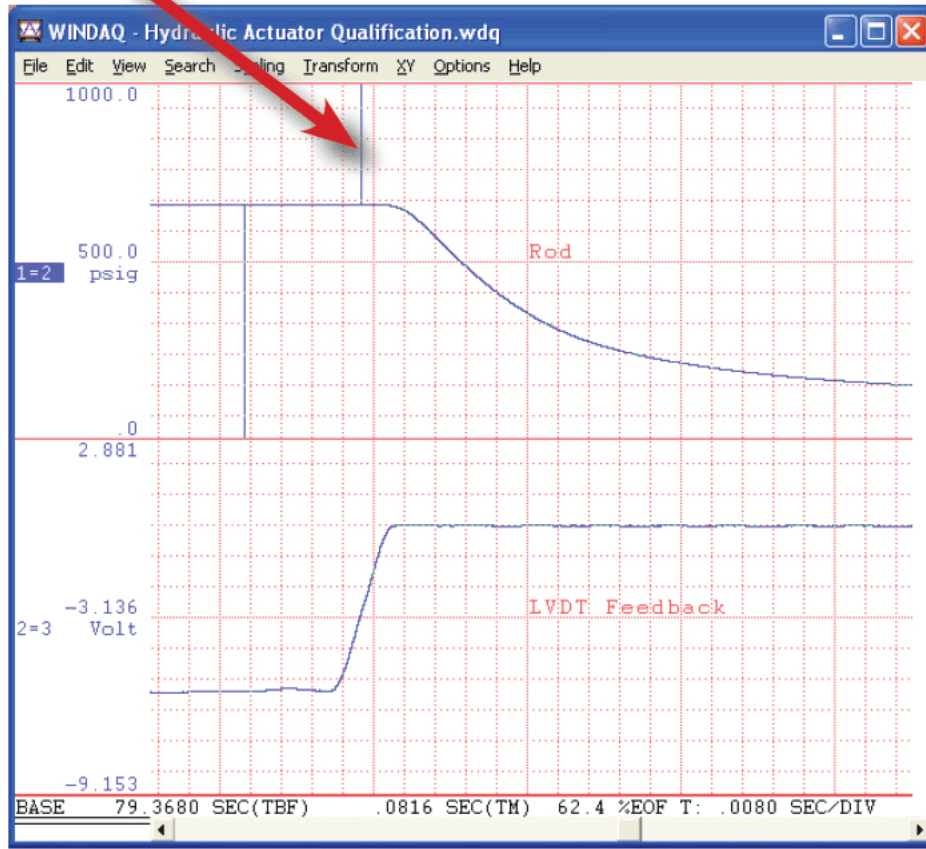

**Please Note: Event Markers do not display in the real-time WINDAQ acquisition software - they only display in the WINDAQ playback software (WVB).*

WINDAQ Remote Storage (D1 Record)

To use a switch closure or TTL signal to begin recording data remotely, connect signal leads to the appropriate Remote Control Record terminals on the DI-4730 as shown below.

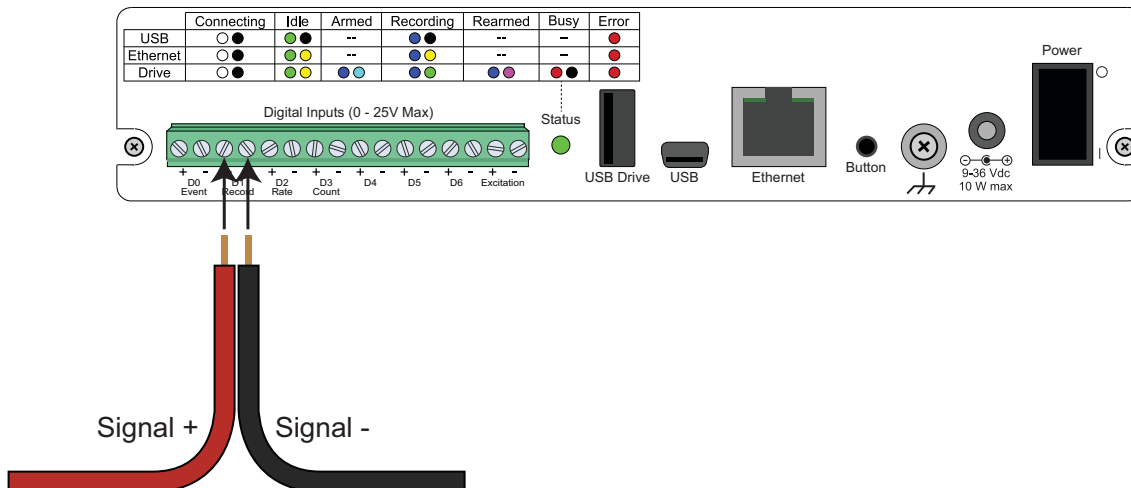

Once the switch closure or TTL signal is connected, activate Remote Storage (Record) through WINDAQ Acquisition Software. Storage to Disk may be automatically placed on the rising or falling edge of the trigger signal. Use the menu command **Options > Remote Storage 1** to set WINDAQ to begin recording on low-to-high transitions of the Record input. Use the menu command **Options > Remote Storage 0** to set WINDAQ to begin recording on high-to-low transitions of the Record input.

WINDAQ Rate (D2 Rate)

Enable channel 10 to record Rate, or the number of falling-edge transitions per unit of time that are applied to this input. Click on **Edit > Channels** in the WINDAQ Acquisition menu to open the Channel Selection grid. Channel 10 is the designated Rate channel. Click on the Channel 10 channel box to enable/disable Rates. The Channel 10 channel box will display an “R” when enabled.

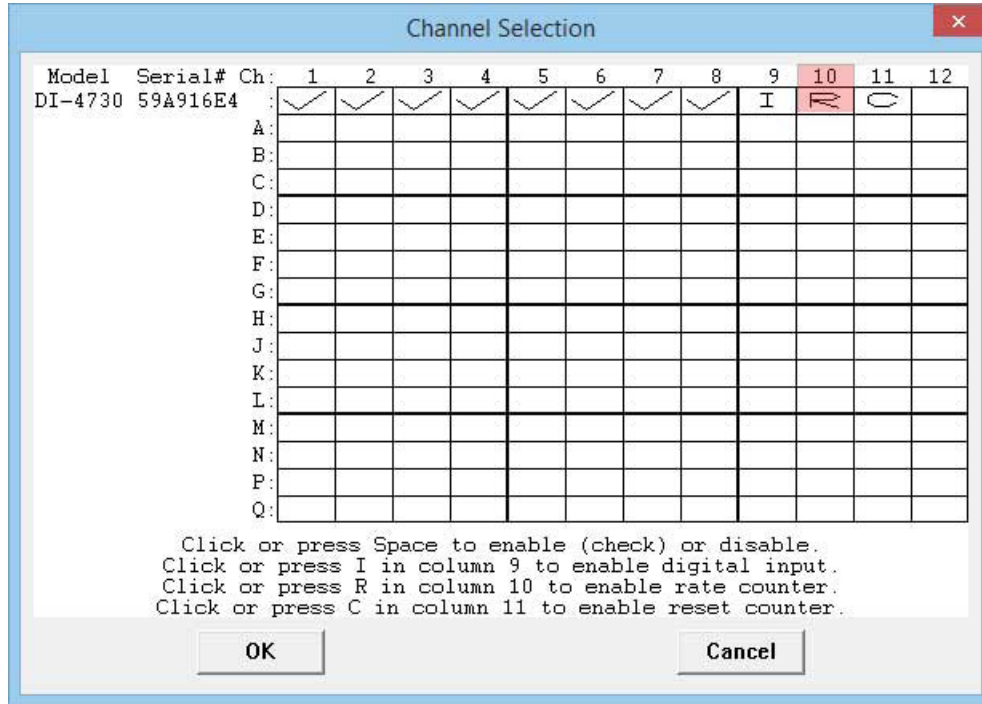

Connect any TTL pulse stream (25 VDC max) to the D2 Rate channel on the DI-4730.

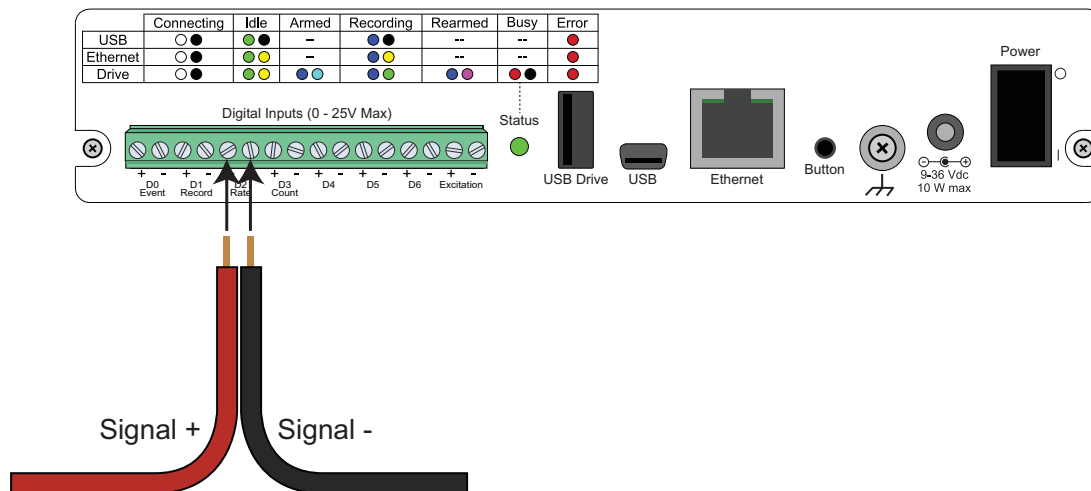

Select Channel 10 in the channel display, then select **Edit > Channel Settings** in the menu to specify a full scale range for the Rate channel. Ranges of 10, 20, 50, 100, 200, 500, 1000, 2000, 5000, 10000, 20000, and 50000 Hz are

available. Choose a range that comes closest to your expected full scale rate or frequency. For example, if you need to measure the output of a flow meter that can measure a maximum flow rate of 100 gallons per minute, and the output frequency at that rate is 100 Hz, you would choose the 100 Hz range setting. A range setting of 200 Hz full scale sacrifices half of the instrument's resolution at 200 gallons per minute, and a range of 50 Hz allows measurements to only 50 gallons per minute full scale.

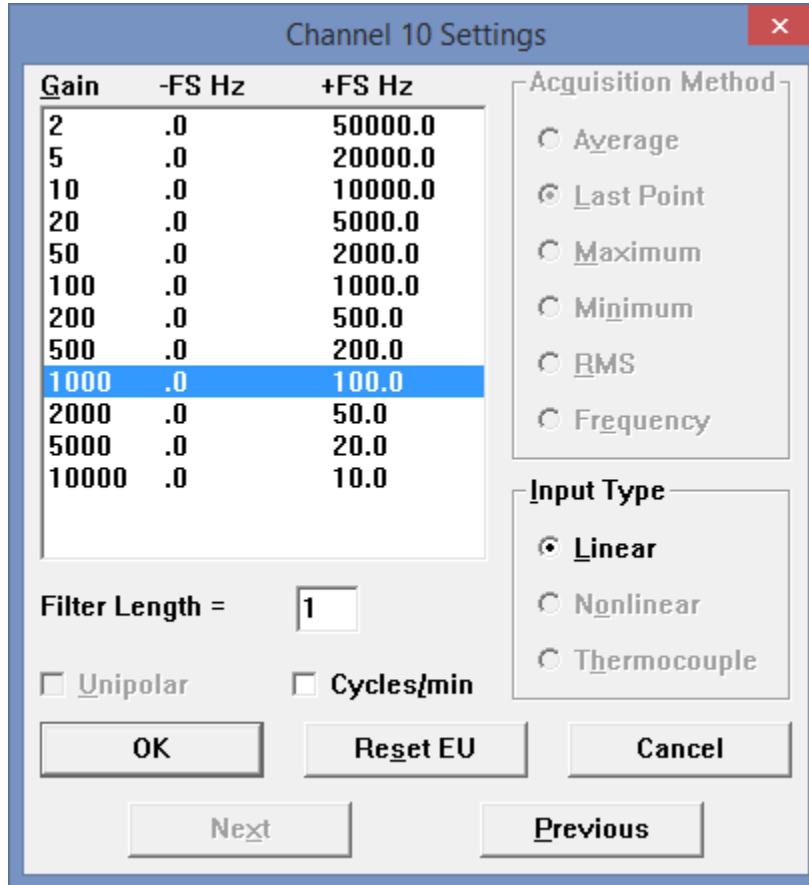

Check the "Cycles/min" box to display and select frequencies reported in cycles per minute instead of cycles per second (the measurement interval remains the same). Tachometer measurements in units of RPM (revolutions per minute) is just one example that benefits from selecting this option. For example, if the 100 Hz range setting is selected and "Cycles/min" is checked, the full scale range is actually 6000 cycles per minute.

Please Note: To measure the maximum rate, which is defined as 2 times the Maximum Sample Rate/Channel, the current values of Maximum Sample Rate/Channel divided by Sample Rate per Channel MUST be an integer.

WINDAQ Counter (D3 Count)

Enable channel 11 to record Counts, or the number of falling-edge transitions that are applied to this input. The count may be reset via WINDAQ software or under program control as necessary. Click on **Edit > Channels** in the WINDAQ

Acquisition menu to open the Channel Selection grid. Channel 11 is the designated Count channel. Click on the Channel 11 channel box to enable/disable Counts. The Channel 11 channel box will display a “C” when enabled.

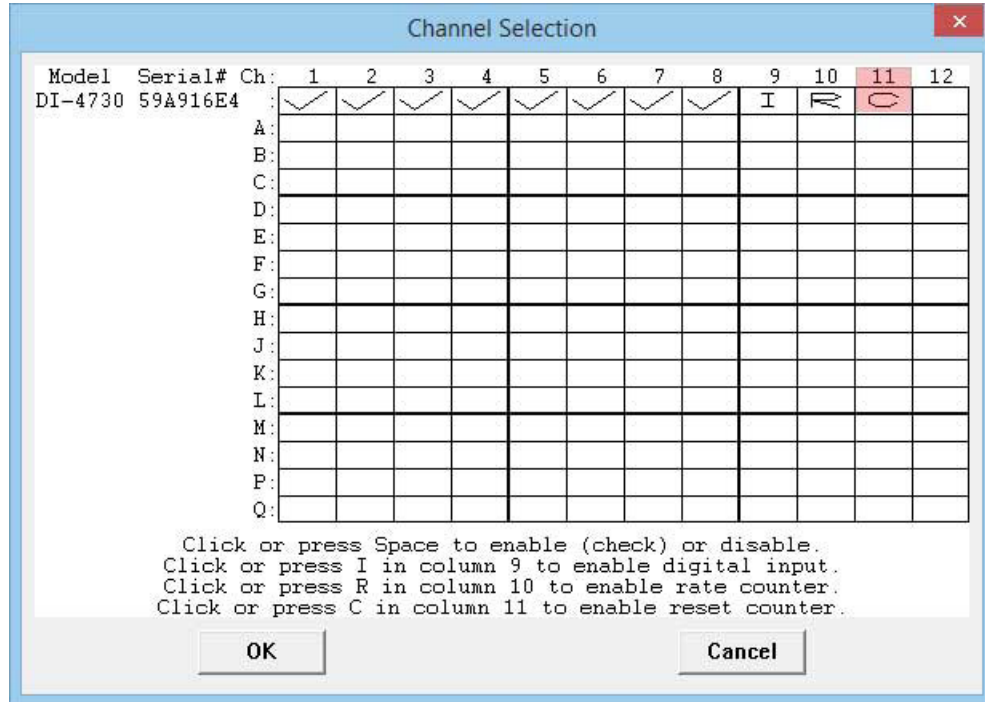

The counter channel accumulates counts over time whether recording or in standby mode as soon as the Counter channel is enabled. The *accumulated* values will be recorded to your data file unless you reset the counts to zero. The maximum count value is 65,535 before the counter resets to zero automatically.

Use the Edit > **Reset Count** command in WINDAQ Acquisition software to reset counts immediately to zero. This feature is available in both standby and record modes.

Use the Edit > Preferences > **Reset Count on New File Record** in WINDAQ Acquisition software to reset the count at the start of a new file or when using the Edit > Preferences > Record Next File on Full or Open Next File on Full feature to reset counts to zero every time a new file is started.

Use the Edit > Preferences > **Reset Count on Manual Record** in WINDAQ Acquisition software to reset counts to zero every time you begin or resume recording a data file using the File > Record command (F4).

Connect any TTL pulse stream (25 VDC max) to the D3 Count channel on the DI-4730.

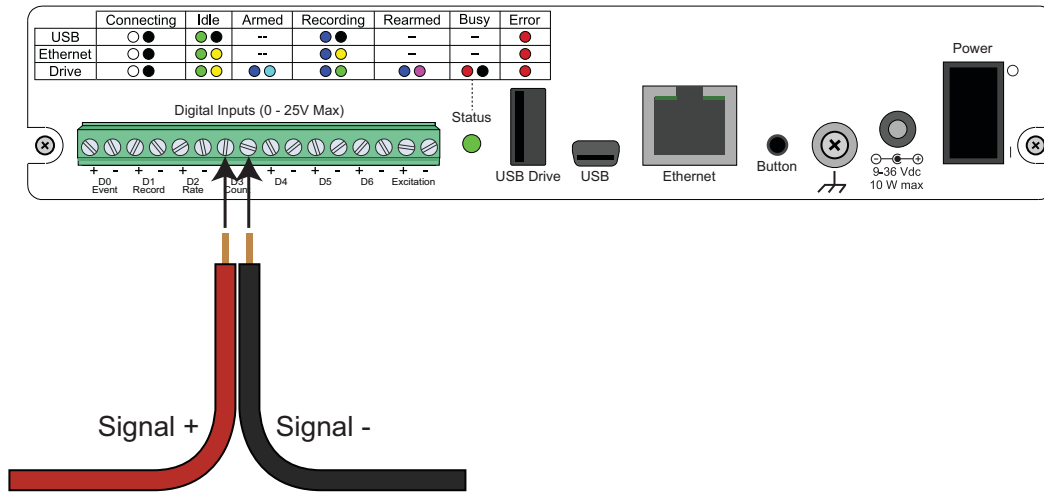

General Purpose Digital Inputs

Enable Channel 9 for general-purpose digital input functions. Click on **Edit > Channels** in the WINDAQ Acquisition menu to open the Channel Selection grid. Channel 9 is the designated Digital Input channel. Click on the Channel 9 channel box to enable/disable the digital inputs. The Channel 9 channel box will display an “I” when enabled.

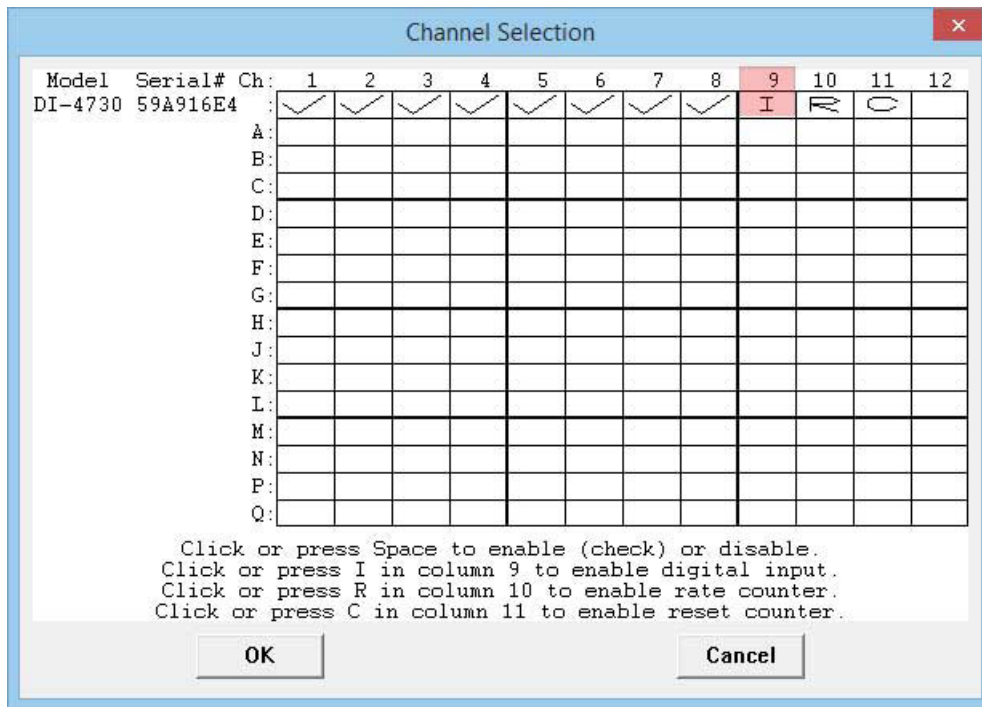

Channel 9 records and displays all the digital inputs, even the state of the Rate and Count inputs if those channels are enabled. With Channel 9 selected in the display window click **Scaling > Digital Plot** to show a digital display and make the data more meaningful on screen.

WinDaq Dashboard

The WinDaq Dashboard allows you to run WinDaq Data Acquisition software, sync the device clock with your PC, modify Ethernet settings, configure your instrument for stand-alone data logging to record data to a USB flash drive, and access the USB thumb drive via the Ethernet interface. Devices in a ChannelStretch™ Group can synchronize data recording in that group. Select all the devices under a ChannelStretch group and click on the Start WinDaq button. Stand-alone data logging is not available using ChannelStretch.

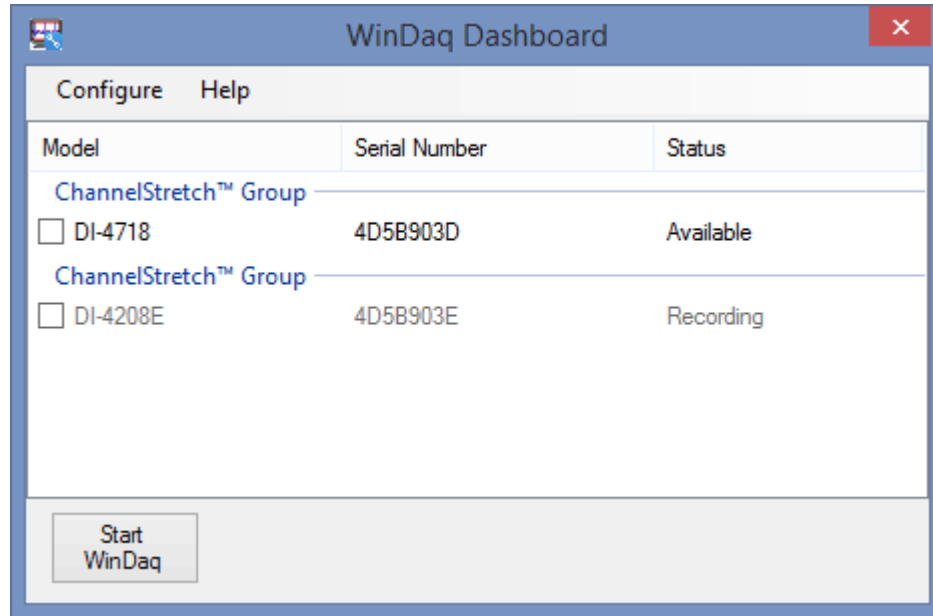

Use the Configure menu to access the Stand alone setup window.

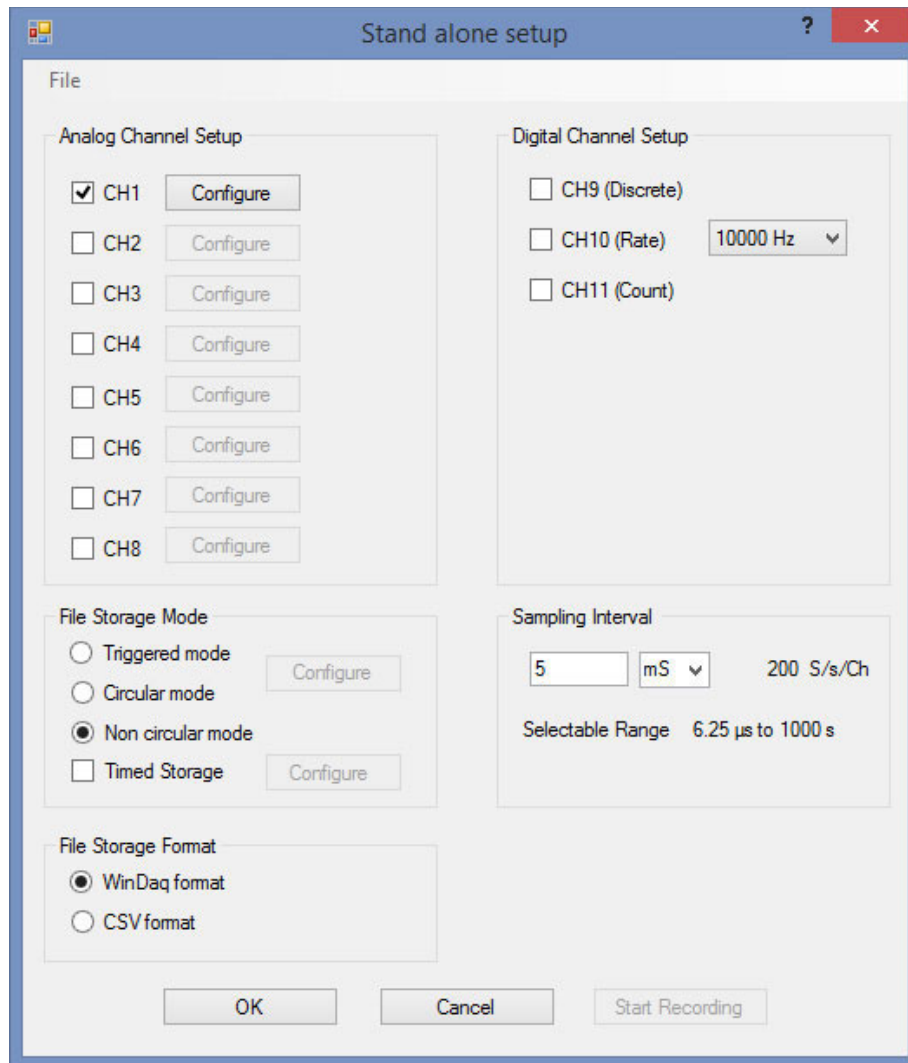

Select and configure all channels available on your device, select a sampling interval, and setup recording Trigger conditions. The Stand alone configuration also allows you to Save/Load configurations via the File menu. Use the help file provided in WinDaq Dashboard to learn more. **Please Note:** You cannot record to the USB thumb drive while the device is connected to your computer's USB port.

ChannelStretch™

Expand the channel count of your DI-4730 with ChannelStretch. Connect up to 16 DI-4730, DI-4718B, DI-4108, and/or DI-4208 devices with a powered USB hub (multiple cascaded/connected powered USB hubs can be used) or Ethernet switch to record more than 8 channels of data to a single WinDaq file. Synchronized units must use the same communications interface to sync. This provides a total of up to 128 analog channels and 112 digital ports at a maximum throughput rate of 480 kHz. Cascade multiple USB hubs or Ethernet switches to expand port count. Synchronized instruments must have the same sample rate per channel, regardless of channel number, type, or range. The WinDaq/Unlock option **per instrument** is required to synchronize two or more devices when using WinDaq software.

Connection

All USB devices must be on the same USB controller (or hub)* in order to synchronize data acquisition. All Ethernet devices must be on the same subnet as the PC that is recording the data (preferably the same Ethernet switch).

ChannelStretch™ Technology

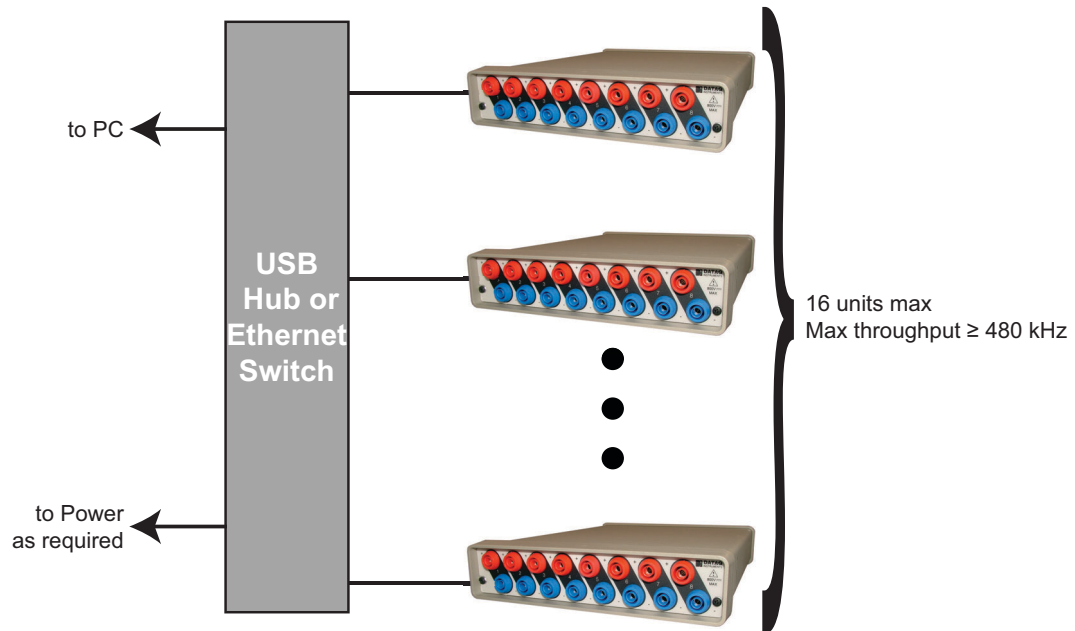

***Please Note:** Because of the way Windows operating systems manage USB controllers, the only way to be absolutely sure you are on the same controller is to use a powered USB hub.

Channel Selection

Devices are listed in the Channel Selection grid in alpha-numeric order of the serial numbers of the device. Devices must be connected to the USB hub before starting WinDaq.

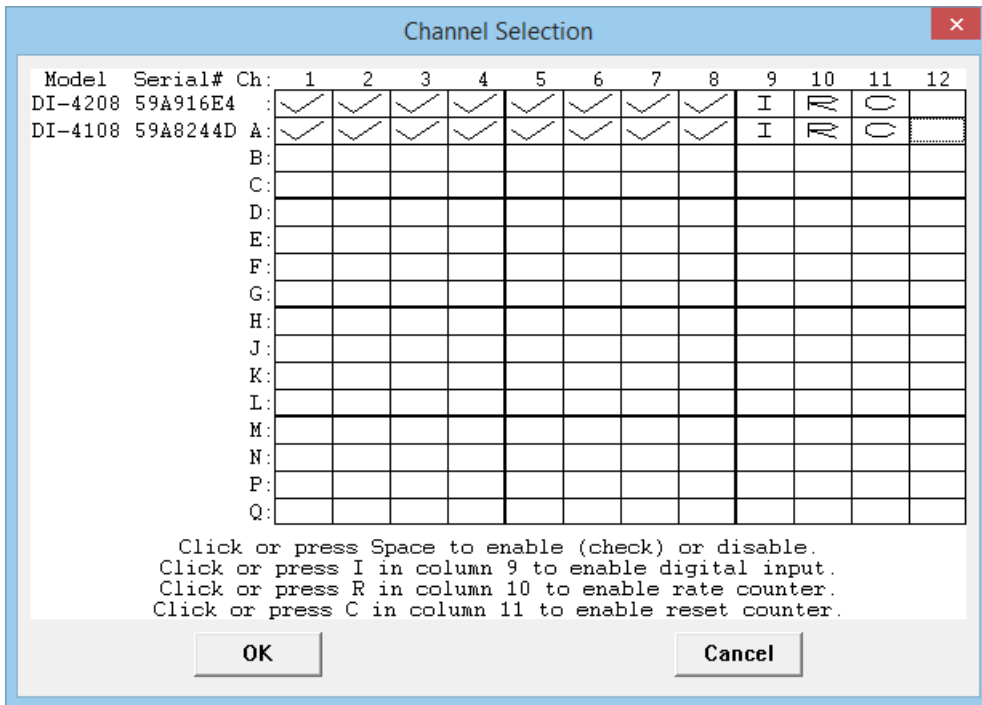

5. Unlock WinDaq and Stand-alone Data Logging

An unlock code is required to record more than a single channel to the USB flash drive or to use ChannelStretch™ to synchronize multiple instruments (unlock code required for each unit to be synchronized). Go to <https://www.dataq.com/products/di-4730/> to purchase the unlock code (under Accessories) or call 330-668-1444. Once purchased, you will be given a Key code to enter into WinDaq Data Acquisition software.

Please Note: If you ordered the unlock code with a new device, the device will ship unlocked and this procedure will not need to be completed.

1. Start WinDaq Acquisition software.
2. Click the menu item **Help > Unlock WinDaq**.

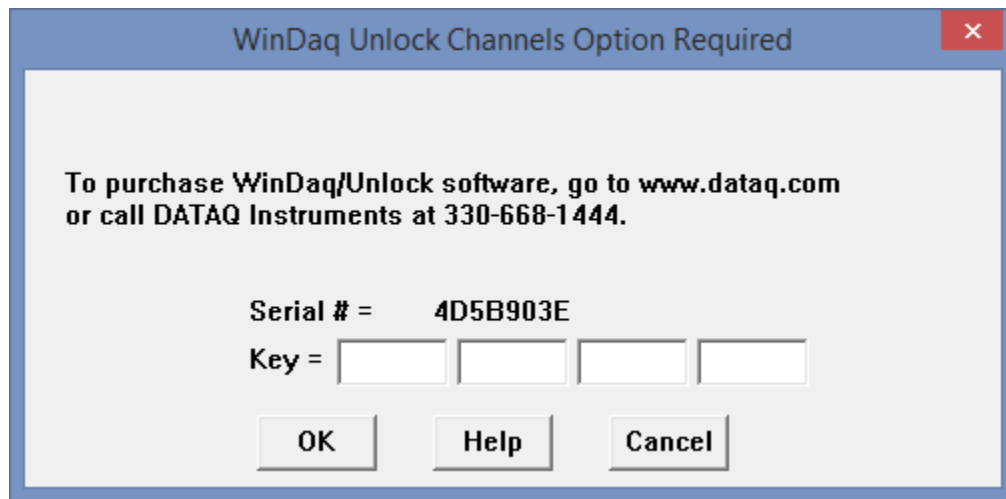

3. Enter the Key in the appropriate dialog boxes.
4. Click **OK**.

Your device is now unlocked for ChannelStretch and stand-alone data logging.

6. Dimensional Drawing

