

GL800

midi LOGGER

USER'S MANUAL

MANUAL NO. GL800-UM-152

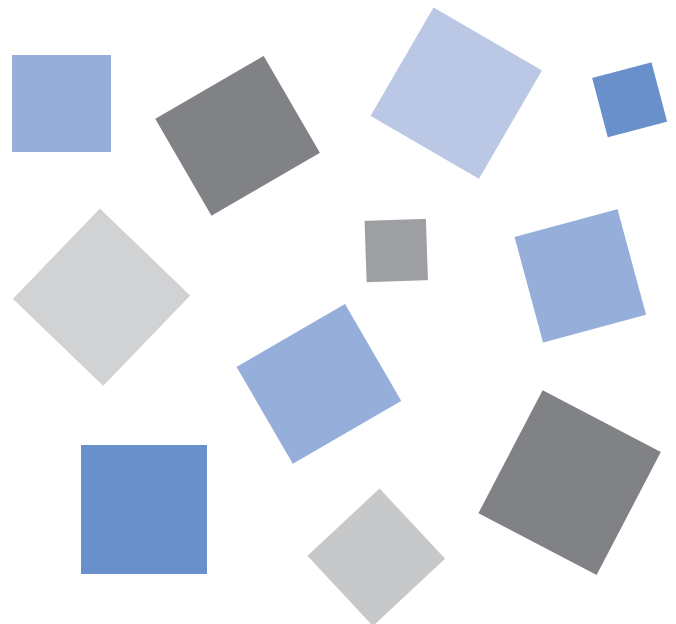

GRAPHTEC

Introduction

Thank you for purchasing the GL800 midi LOGGER.

Please read this manual thoroughly before attempting to use your new product to ensure that you use it correctly and to its full potential.

Notes on Use

Be sure to read all of the following notes before attempting to use the GL800 midi LOGGER.

1. Note on the CE Marking

The GL800 complies with the EN61326 (1997+A1:1998+A2:2001 Class A) standard based on the EMC directive (89/336/EMC). It also conforms to the EN61010-1 (1993/A2:1995) standard based on the LV directive (72/73/EEC).

Although the GL800 complies with the above-mentioned standards, be sure to use it correctly in accordance with the instructions and notes provided in its User's Manual.

Moreover, use of the GL800 by incorrect procedures may result in damage to the GL800 or may invalidate its safeguards. Please confirm all of its notes regarding use and other related information to ensure correct use.

2. Warning

This is a Class A product according to the EMC directive.

In a domestic environment, this product may cause radio interference or may be affected by radio interference to the extent that proper measurement cannot be performed.

3. Notes for Safe Operation

- (1) Be sure to use the Graphtec-supplied AC adapter. In environments where there is a lot of noise or where the power supply is unstable, we recommend that you ground the GL800.
- (2) When a high-voltage signal cable has been connected to the main unit's analog signal input terminal, avoid touching the leads of the input terminal's signal cable to prevent electrical shock due to high voltage.
- (3) Ensure that the GL800's power source is positioned so that it can easily be disconnected.

4. Notes on Functions and Performance

- (1) Be sure to connect the main unit to an AC or DC power supply that conforms to the rated range. Connection to a non-rated power supply may cause the main unit to overheat and break down.
- (2) Do not block the vent on the main unit. Continued operation with the vent blocked may cause the main unit to overheat and break down.
- (3) To avoid malfunctions and other damage, avoid using the GL800 in the following locations.
 - Places exposed to high temperature and/or high humidity, such as in direct sunlight or near heating equipment. (Operating range - Temperature: 0 to 45°C (15 to 40°C when battery pack is mounted), Humidity: 5 to 85% RH)
 - Locations subject to excessive salt spray or heavy fumes from corrosive gas or solvents.
 - Excessively dusty locations.
 - Locations subject to strong vibrations or shock.
 - Locations subject to surge voltages and/or electromagnetic interference.
- (4) If the main unit becomes soiled, wipe it off using a soft, dry cloth. Use of organic solvents (such as thinner or benzene) causes deterioration and discoloration of the outer casing.

Introduction

- (5) Do not use the GL800 in the vicinity of other devices which are susceptible to electromagnetic interference.
- (6) Measured results may not conform to the stated specifications if the GL800 is used in an environment which is subject to strong electromagnetic interference.
- (7) Insofar as possible, position the GL800 input signal cables away from any other cables which are likely to be affected by electromagnetic interference.
- (8) For stabilized measurement, allow the GL800 to warm up for at least 30 minutes after turning it on.

To Ensure Safe and Correct Use

- To ensure safe and correct use of the GL800, read this Manual thoroughly before use.
- After having read this Manual, keep it in a handy location for quick reference as needed.
- Do not permit small children to touch the GL800.
- The following describes important points for safe operation. Please be sure to observe them strictly.

Conventions Used in This Manual

To promote safe and accurate use of the GL800 as well as to prevent human injury and property damage, safety precautions provided in this manual are ranked into the five categories described below. Be sure you understand the difference between each of the categories.



DANGER

This category provides information that, if ignored, is highly likely to cause fatal or serious injury to the operator.



WARNING

This category provides information that, if ignored, is likely to cause fatal or serious injury to the operator.



CAUTION

This category provides information that, if ignored, could cause physical damage to the GL450.



HIGH TEMPERATURE

This category provides information that, if ignored, is likely to cause burns or other injury to the operator due to contact with high temperature.





ELECTRICAL SHOCK



This category provides information that, if ignored, is likely to expose the operator to electrical shock.

Description of Safety Symbols





The  symbol indicates information that requires careful attention (which includes warnings). The point requiring attention is described by an illustration or text within or next to the  symbol.



The  symbol indicates action that is prohibited. Such prohibited action is described by an illustration or text within or next to the  symbol.



The  symbol indicates action that must be performed. Such imperative action is described by an illustration or text within or next to the  symbol.

Safety Precautions

WARNING

Be sure to securely connect the GL800's power cord.

- After checking that the Power switch is turned off, connect the power cord's female plug to the GL800 and then connect its male plug into the electrical socket.
- Use of the GL800 without the power cord securely plugged into the electrical socket may result in electrical shock due to current leakage.
- Before running the GL800 using a DC power supply, be sure to ground the protective ground terminal () to avoid electrical shock and fire hazards. For grounding, use a ground wire with a diameter of at least 0.75 mm². When using the GL800 in an environment where grounding is not possible, ensure that the voltage to be measured is no greater than 50 V (DC or rms).



Securely connect the power cord
Make sure that the socket has a good protective ground

If the GL800 generates smoke, is too hot, emits a strange odor, or otherwise functions abnormally, turn off its power and unplug its power cord from the electrical socket.

- Use of the GL800 in such status may result in a fire hazard or electrical shock.
- After checking that smoke is no longer being generated, contact your sales representative or nearest Graphtec vendor to request repair.
- Never try to perform repair yourself. Repair work by inexperienced personnel is extremely dangerous.



Amateur repair prohibited

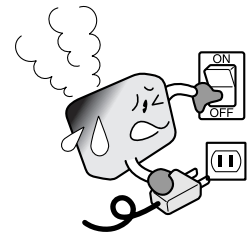

Before turning on the GL800, ensure that the electric socket's supply voltage conforms to the GL800's power rating.

- Use of a different supply voltage may cause damage to the GL800 or a fire hazard due to electrical shock or current leakage.



Use of a different supply voltage prohibited

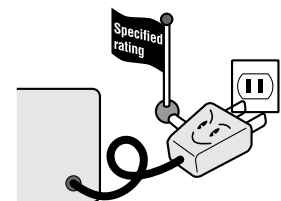

Never disassemble or remodel the GL800.

- Such action may cause a fire hazard due to electric shock or current leakage.
- Contact with a high-voltage component inside the GL800 may cause electric shock.
- If repair is required, contact your sales representative or nearest Graphtec vendor.



No disassembly



Avoid using the GL800 in extremely dusty or humid places.

- Such use may cause a fire hazard due to electrical shock or current leakage.



Use prohibited



Watch out for electrical shock



Safety Precautions

WARNING

Avoid using the GL800 in places where it may be exposed to water such as bathrooms, locations exposed to wind and rain, and so on.



Avoid water



Watch out for electrical shock

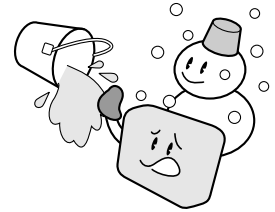

Prevent dust or metallic matter from adhering to the power supply connector.

- Adhesion of foreign matter may cause a fire hazard due to electrical shock or current leakage.



No foreign matter



Watch out for electrical shock

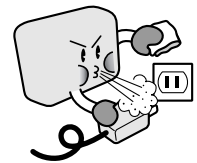

Never use a damaged power cord.

- Use of a damaged cord may result in a fire hazard due to electrical shock.
- If the cord becomes damaged, order a new one to replace it.



Unplug the power cord from the socket

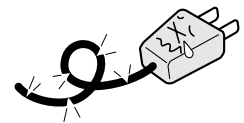

Safety Precautions

CAUTION

Do not use or store the GL800 in a location exposed to direct sunlight or the direct draft of an air conditioner or heater.

- Such location may impair the GL800's performance.

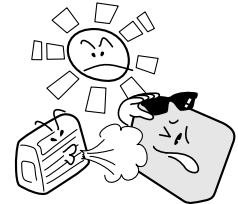

Do not place coffee cups or other receptacles containing fluid on the GL800.

- Fluid spilling inside the GL800 may cause a fire hazard due to electrical shock or current leakage.



Avoid fluids



Watch out for electrical shock



Do not use the GL800 in a location subject to excessive mechanical vibration or electrical noise.

- Such location may impair the GL800's performance.



Use prohibited

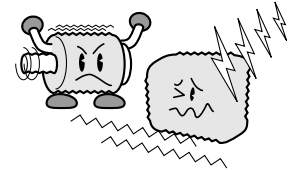

To insert or disconnect the power cord or a signal input cable, grasp the power cord's plug or the signal input cable's connector.

- Pulling the cord/cable itself damages the cord/cable, resulting in a fire hazard or electrical shock.



No pulling

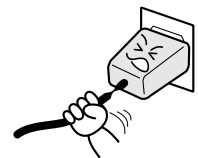

If fluid or foreign matters enters inside the GL800, turn off the Power switch and disconnect the power cord from the electrical socket.

- Use in such status may cause a fire hazard due to electrical shock or current leakage.
- Contact your sales representative or nearest Graphtec vendor to request repair.



Unplug the power cord from the socket

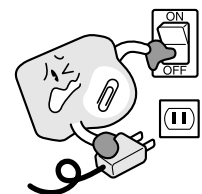

Do not input voltage that exceeds the permissible input voltage range that is specified on the GL800's label.

- Exceeding the specified voltage input range may cause electrical shock or a fire hazard.



Use prohibited

Safety Precautions

CAUTION

Do not attempt to lubricate the GL800's mechanisms.

- Such action may cause the GL800 to break down.



No lubrication

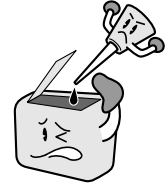

Never clean the GL800 using a volatile solvent (such as thinner or benzene).

- Such action may impair the GL800's performance.
- Clean off any soiled areas using a soft dry cloth.



No volatile solvents

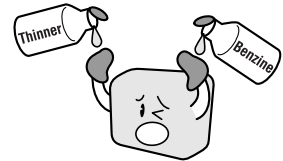

CONTENTS

Introduction	i
To Ensure Safe and Correct Use	iii
Conventions Used in This Manual	iii
Description of Safety Symbols	iii
Safety Precautions	iv

General Description 1-1

1.1 Overview	1-2
1.2 Features	1-2
Input	1-2
Display & Operation	1-2
Data Capture	1-2
Data Control & Processing	1-2
1.3 Operating Environment	1-3
Ambient Operating Conditions	1-3
Warming-up Before Use	1-3
Configuration When in Use	1-3
1.4 Notes on Temperature Measurement	1-4
1.5 Notes on Using the Monitor	1-4
1.6 Changing the Display Language	1-4

Checks and Preparation 2-1

2.1 Checking the Outer Casing	2-2
2.2 Checking the Accessories	2-2
2.3 GL800 Part Names and Functions	2-3
2.4 Connecting the Power Cable and Turning on the Power	2-4
Connecting to an AC Power Supply	2-4
Connecting to a DC Power Supply	2-5
2.5 Connecting the Signal Input Cables	2-6
Terminal Configuration and Signal Types	2-6
Connection diagram	2-6
2.6 Logic Alarm Cable Connection and Functions	2-7
Circuit Example of Relay Drive by Alarm Output	2-7
2.7 Attaching USB Memory	2-9
Inserting a USB Memory	2-9
2.8 Connecting to a PC	2-10
Connection Using a USB Cable	2-10
LAN Connection	2-11
2.9 Using the Battery Pack (Option)	2-12
Mounting the Battery Pack	2-12
Charging the Battery	2-13
2.10 Connecting the Humidity Sensor (Option)	2-14
2.11 Mounting and Removing the Terminal Unit	2-15
To Remove	2-15
To Mount	2-16

- 2.12 Mounting the Extension Terminal Base Set (B-537) 2-17**
 - B-537 Set Contents 2-17
 - To Mount 2-17
- 2.13 Mounting the 20 Channel Extension Terminal Set (B-538) 2-18**
 - B-538 Set Contents 2-18
 - To Mount 2-18
- 2.14 Precautions to Observe When Performing Measurement 2-20**
- 2.15 Noise Countermeasures 2-21**
- 2.16 Setting the Date and Time 2-22**
 - How to Recharge the Rechargeable Battery 2-22
 - How to Set the Date and Time 2-22

Settings and Measurement 3-1

- 3.1 Window names and functions 3-2**
- 3.2 Key Operation 3-4**
 - (1) CH GROUP 3-4
 - (2) SPAN/TRACE/POSITION 3-5
 - (3) TIME/DIV 3-5
 - (4) MENU 3-6
 - (5) QUIT (LOCAL) 3-6
 - (6) Direction keys 3-6
 - (7) ENTER 3-7
 - (8) FAST FORWARD key (KEY LOCK) 3-7
 - (9) START/STOP (USB Drive Mode) 3-7
 - (10) REVIEW 3-8
 - (11) DISPLAY 3-9
 - (12) CURSOR (ALARM CLEAR) 3-10
 - (13) FILE 3-10
 - (14) NAVI 3-11
 - Basic Procedures Used in Settings 3-11
- 3.3 Operation Modes 3-12**
 - (1) Free Running 3-12
 - (2) Capturing 3-13
 - (3) Dual View Replaying 3-13
 - (4) Replaying 3-14
- 3.4 Setting Menus 3-15**
- 3.5 WEB Server Function 3-38**

Specifications 4-1

- 4.1 Standard Specifications 4-2**
 - Standard Specifications 4-2
 - Internal memory devices 4-3
 - PC Interface 4-3
 - Monitor 4-3
 - Input Unit Specifications 4-4
- 4.2 Function Specifications 4-5**
 - Function Specifications 4-5
 - Trigger Functions 4-5
 - External Input/Output Functions 4-6

4.3	Accessory/Option Specifications	4-7
	Control Software	4-7
	Accessories	4-7
	Battery Pack B-517 (Option)	4-7
	Humidity Sensor B-530 (Option)	4-8
	Options	4-8
4.4	External Dimensions	4-9

Index	I-1
--------------------	------------

CHAPTER 1

General Description

This chapter provides a general description of the GL800 and its features.

- 1.1 Overview**
- 1.2 Features**
- 1.3 Operating Environment**
- 1.4 Notes on Temperature Measurement**
- 1.5 Notes on Using the Monitor**
- 1.6 Changing the Display Language**

1.1 Overview

The GL800 (with color monitor and internal memory) are compact, lightweight, multi-channel data loggers.

GL800 are provided with 20 channels as a standard measurement feature, or can be extended up to 200 channels by attaching additional terminal sets.

GL800 are also equipped with an internal flash memory to store data and enable the direct capture of a large volume of data to USB memory.

Furthermore, the data loggers are equipped with USB and Ethernet interfaces to a PC to enable system configurations according to your application.

The Ethernet feature includes WEB and FTP server functions which allow monitoring from a remote location and data transfer.

1.2 Features

Input

- (1) Adoption of a pluggable M3 screw type input terminal facilitates wiring.
- (2) The GL800 is provided with 20 channels as a standard measurement feature, or can be extended up to 200 channels by attaching additional terminal sets.
- (3) All channels are isolated, enabling measurement of signals of different references.

Display & Operation

- (1) With the GL800's 5.7-inch TFT color liquid crystal display, you can confirm the waveforms of measured data and each channel's settings at a glance.
- (2) Easy operation is achieved through a straightforward menu structure and key allocation which resembles mobile phones.

Data Capture

- (1) Data can be directly captured and maintained in the internal or USB memory.
- (2) Internal memory used for the built-in memory maintains captured data even after the power is turned off.
- (3) The Internal memory can be used with disk images thus multiple data items can be maintained.

Data Control & Processing

- (1) The application software provided lets you set conditions and monitor data on a PC.
- (2) The USB drive mode function enables the GL800's internal memory to be recognized as an external drive by your PC. (Connect the GL800 to your PC and turn on the power supply to the GL800 while holding down the [START] key.)
- (3) Captured data can be read from the application software to files and displayed for processing.
- (4) Data can be transferred off-line to a computer using USB memory.
- (5) The WEB server function enables control and monitoring from a remote location without using dedicated software.
- (6) The FTP server function enables handling internal memory and USB memory data from a PC.

1.3 Operating Environment

This section explains the operating environment for the GL800.

Ambient Operating Conditions

- (1) Ambient temperature and humidity (the GL800 must be operated within the following ranges.)
 - Temperature range: 0 to 45°C (15 to 40°C when battery pack is mounted)
 - Humidity range: 5 to 85% RH
- (2) Environment (do not use in the following locations.)
 - A Location such as being exposed to direct sunlight
 - Locations exposed to salty air, corrosive gases, or organic solvents
 - Dusty locations
 - Locations subject to vibration or impact
 - Locations subject to voltage surge or electromagnetic interference such as lightning or electric furnaces
- (3) Installation category (over-voltage category)
 - The GL800 conforms to the IEC664 installation category 1

CHECKPOINT

If condensation occurs...

Condensation occurs in the form of water droplets on the device surfaces and interior when the GL800 is moved from a cold to a warm location. Using the GL800 with condensation will cause malfunctioning. Wait until the condensation has disappeared before turning on the power.

Warming-up Before Use

The GL800 should be allowed to warm up with the power turned on for approximately 30 minutes to ensure that it operates according to the specified performance.

Configuration When in Use

Do not use the GL800 standing upright or at an angle. It must always be laid flat.

Usage Configuration

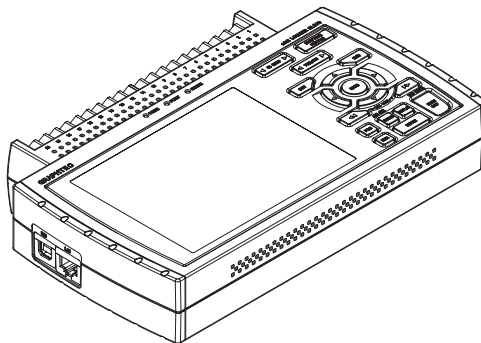

CAUTION

Do not block the air vent on the GL800, as this will cause malfunctioning. Measurement accuracy may not be satisfactory if the system is used in a condition other than described above.

1.4 Notes on Temperature Measurement

Please observe the following precautions when performing temperature measurement.

- (1) Do not block the air vents. Always provide a space of at least 30 cm on all sides of the GL800.
- (2) For stabilized temperature measurement, allow the GL800 to warm up for at least 30 minutes after turning it on.
- (3) Exposure of the input terminals to direct drafts, direct sunlight, or abrupt changes in temperature may impair the equilibrium of the input parts and result in measurement errors. To measure temperature in such an environment, take appropriate countermeasures such as changing the installation site of the GL800.
- (4) To conduct measurement in noisy environments, connect the GL800's GND terminal to ground (refer to page 2-21).
- (5) If measured values fluctuate due to noise, set to a slower sampling speed (refer to page 3-20).

1.5 Notes on Using the Monitor

The monitor is an LCD display unit, and so the display will vary depending on the operating environment.

CHECKPOINT

If the screen saver function is used, it will operate and clear the screen if no operations are performed during the preset time. If the screen saver operates, press any key to restore the display.

CAUTION

- Condensation may form on the LCD screen if the GL800 is moved from a cold to a warm location. If this occurs, wait until the LCD screen warms up to room temperature.
 - The LCD screen is manufactured to extremely high precision. Black dots may appear, or red, blue, and green dots may not disappear. Likewise, streaks may appear when viewed from certain angles. These phenomena are due to the LCD screen construction, and are not signs of a fault.
-

1.6 Changing the Display Language

You can choose the language displayed on the screen. The default display language is set to English when the GL800 is shipped overseas. To change the display language, see the instructions in "OTHR:Language".

CHAPTER 2

Checks and Preparation

This chapter explains how to check the GL800's external casing and accessories, and how to prepare the GL800 for operation.

- 2.1 Checking the Outer Casing**
- 2.2 Checking the Accessories**
- 2.3 GL800 Part Names and Functions**
- 2.4 Connecting the Power Cable and Turning on the Power**
- 2.5 Connecting the Signal Input Cables**
- 2.6 Logic Alarm Cable Connection and Functions**
- 2.7 Attaching USB Memory**
- 2.8 Connecting to a PC**
- 2.9 Using the Battery Pack (Option)**
- 2.10 Connecting the Humidity Sensor (Option)**
- 2.11 Mounting and Removing the Terminal Unit**
- 2.12 Mounting the Extension Terminal Base Set (B-537)**
- 2.13 Mounting the 20 Channel Extension Terminal Set (B-538)**
- 2.14 Precautions to Observe When Performing Measurement**
- 2.15 Noise Countermeasures**
- 2.16 Setting the Date and Time**

2.1 Checking the Outer Casing

After unpacking, check the GL800's outer casing before use. In particular, please check for the following:

- Surface scratches
- Other flaws such as stains or dirt

2.2 Checking the Accessories

After unpacking, check that the following standard accessories are included.

Standard Accessories

Item	Remarks	Quantity
Quick Start Guide	GL800-UM-85x	1
CD-ROM	User's Manual, Application software	1
AC cable/AC adapter	100 to 240 VAC, 50/60 Hz	1

Optional Accessories

Item	Option No.	Remarks
Battery pack	B-517	7.2V/2200mAh
DC drive cable	B-514	2 m, Bare tips
Humidity sensor	B-530	3-m length with dedicated power connector
Extension terminal base set	B-537	Extension terminal base unit, cable
20 channel extension terminal set	B-538	20 channel terminals, extension terminal base unit, connection plate, screws
Logic alarm cable	B-513	2 m, Bare tips
T-type thermocouple	JBS-7115-5M-T	5-m length, 4 thermocouples per set
K-type thermocouple	JBS-7115-5M-K	5-m length, 4 thermocouples per set
K-type thermocouple (needle type probes)	RIC-410	1.1m
K-type thermocouple (stationary surface probes)	RIC-420	1.1m
K-type thermocouple (stationary surface L probes)	RIC-430	1.1m

2.3 GL800 Part Names and Functions

This section describes the names and function of parts of the GL800.

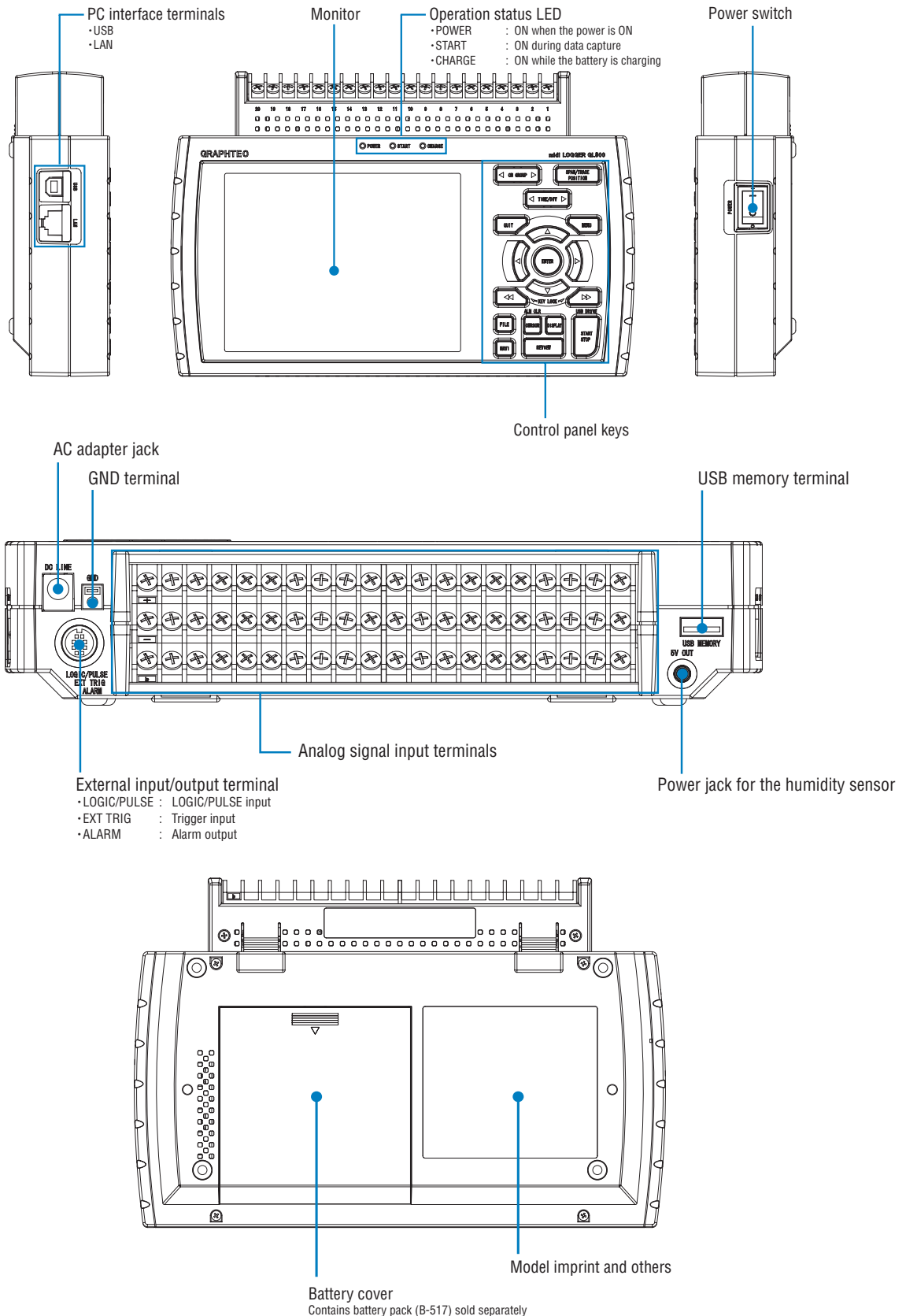

2.4 Connecting the Power Cable and Turning on the Power

This section describes how to connect the power cable and turn on the power. The connection method will vary depending on the type of power supply used.

Connecting to an AC Power Supply

Use the AC cable and AC adapter that are provided as accessories.

⚠ CAUTION

Be sure to use the AC adapter that is supplied as a standard accessory.

- (1) Plug the AC cable into the AC adapter.

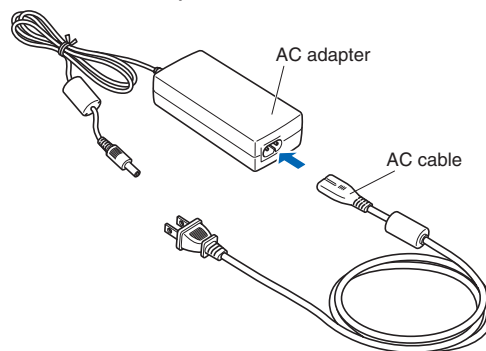

- (2) Connect the output side of the AC adapter to the connector on the GL800.

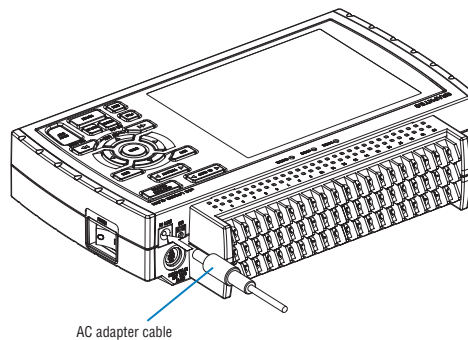

- (3) Using the flat-blade screwdriver, press against the minus (-) button above the GND terminal, while connecting the grounding cable to the GL800. Connect the other end of the cable to ground.

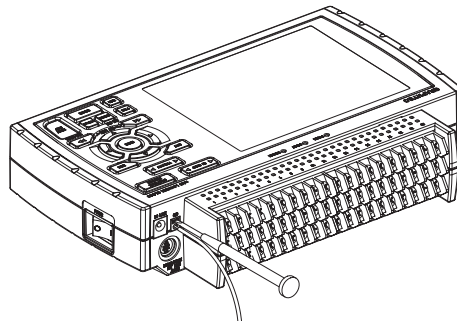

- (4) Plug the AC cable into the mains power outlet.
- (5) Press the power switch on the GL800 to the ON side to turn on the power.

⚠ CAUTION

Always connect the GND terminal and refer to the safety precautions. The GL800 must be grounded even when connected to other devices and sharing a common ground level.

Connecting to a DC Power Supply

Use the optional DC drive cable (B-514).

CAUTION

Use a power supply within the 8.5 to 24 VDC range.

- (1) Configure the tip of the DC drive cable (B-514: 2m) to enable it to be connected to the DC power supply.
- (2) Connect the DC output side to the power supply connector on the GL800.

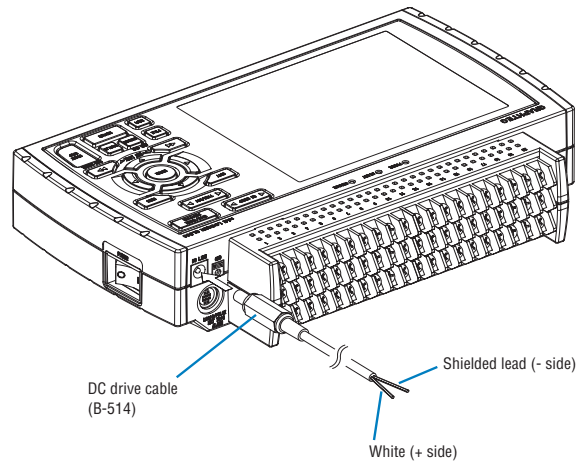

- (3) Connect the DC input side to the DC power supply.

CAUTION

Be sure to check the polarity of the wire tips when performing wiring.

- (4) Press the power switch on the GL800 to the ON side to turn on the power.

2.5 Connecting the Signal Input Cables

This section describes how to connect the signal input cables.

Terminal Configuration and Signal Types

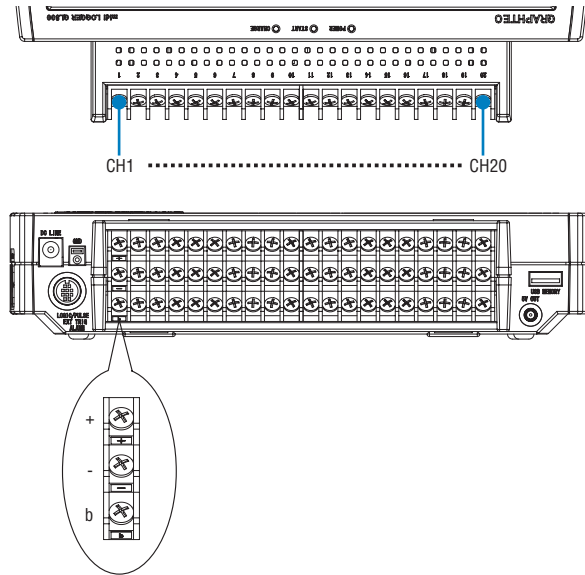

Connection diagram

Direct voltage input

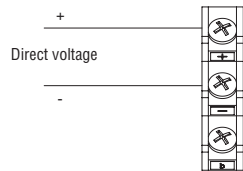

Thermocouple input

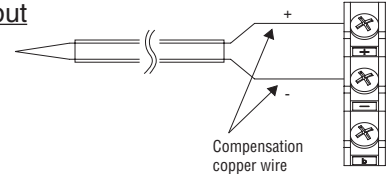

Resistance temperature detector input

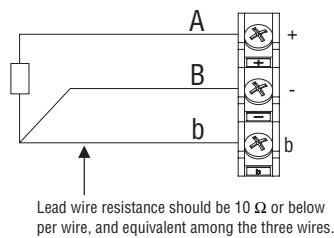

Direct current input

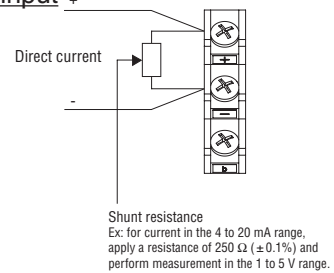

- + High-voltage terminal (terminal for high-voltage input signals)
 - Low-voltage terminal (terminal for low-voltage input signals)
 - b Dedicated terminal when connecting resistance temperature detector
- *Resistance temperature detector input terminals A (+) and B (-) are isolated within each channel. Terminal b is shorted within all channels.

Item	Description
Input configuration	Isolated input, scanning
Analog voltage	20, 50, 100, 200, 500 mV/F.S.; 1, 2, 5, 10, 20, 50 V/F.S.; 1-5V
Thermocouples	K, J, E, T, R, S, B, N, W (WRe 5-26)
Resistance temperature detector	PT100, JPT100, PT1000 (IEC751)
A/D resolution	16-bit
Filter	Off, 2, 5, 10, 20, 40 Filter operation is on a moving average basis. The average value of the set sampling count is used.

2.6 Logic Alarm Cable Connection and Functions

The logic alarm cable (B-513) enables logic/pulse input, external trigger input, and alarm signal output. Connect the logic alarm cable (B-513) to the external input/output terminal as shown below.

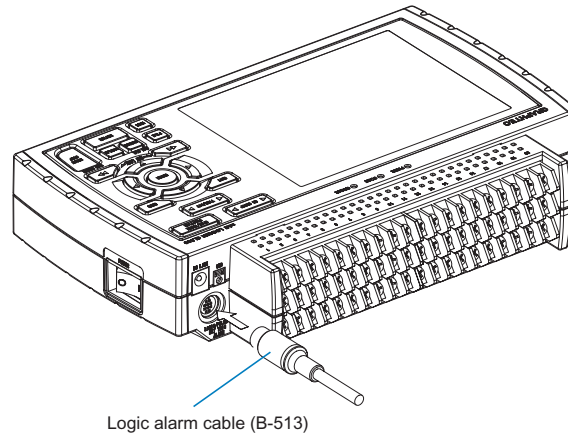

Logic/Pulse Specifications

Item	Description
Number of input channels	4
Input voltage range	0 to +24V max. (single-ended ground input)
Threshold level	Approx. +2.5V
Hysteresis	Approx. 0.5 V (+2.5 to +3 V)

*Switch between logic and pulse input.

Trigger Input Specifications

Item	Description
Number of input channels	1
Input voltage range	0 to +24V max. (single-ended ground input)
Threshold level	Approx. +2.5V
Hysteresis	Approx. 0.5 V (+2.5 to +3 V)

Alarm Output Specifications

Item	Description
Number of output channels	4
Output format	Open collector output +5 V, 10 K Ω pull-up resistance Contact capacity 5 V to 24 V, 100 mA or below

Circuit Example of Relay Drive by Alarm Output

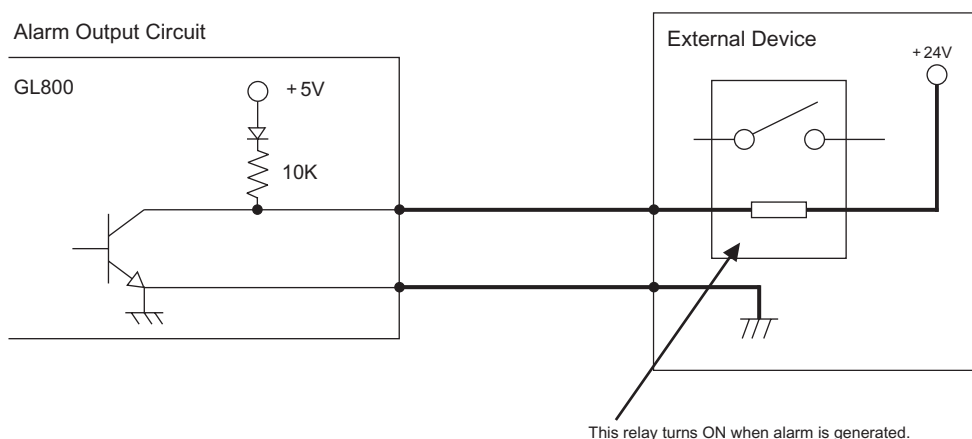

This relay turns ON when alarm is generated.

Wiring

Cable tips are bare tips. Perform wiring for the necessary functions.

Signal Name	Channel Number	Wire Color
Logic/Pulse output	1	Orange with red dotted line
	2	Orange with black dotted line
	3	Grey with red dotted line
	4	Grey with black dotted line
Alarm output	1	White with red dotted line
	2	White with black dotted line
	3	Yellow with red dotted line
	4	Yellow with black dotted line
Trigger input		Pink with red dotted line
GND		Pink with black dotted line
		Shielded

*Switch between logic and pulse.

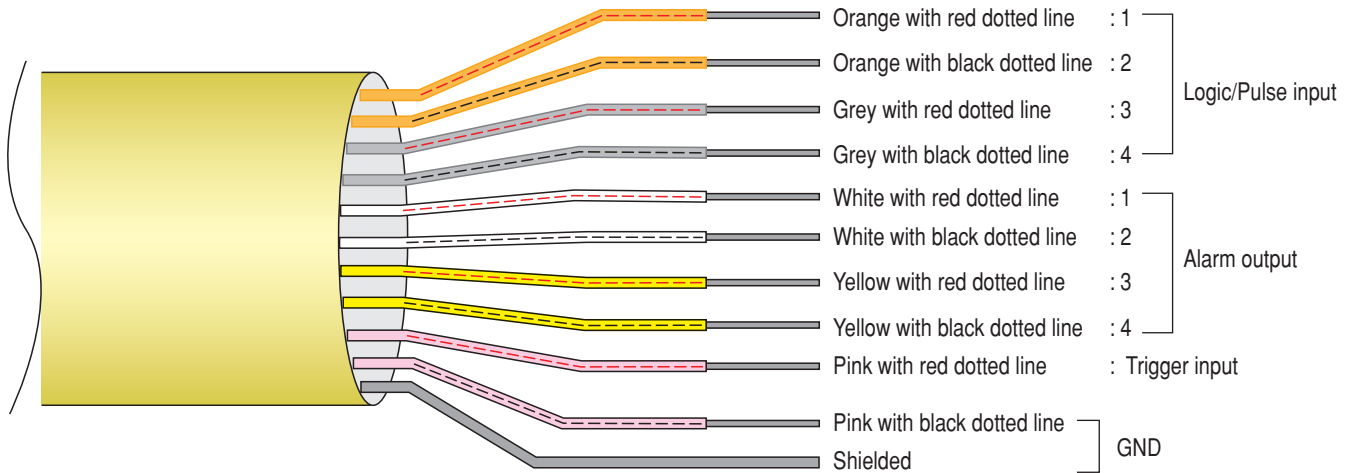

2.7 Attaching USB Memory

Attaching USB memory to the GL800 allows you store measured data directly.

CAUTION

Adequate precautions against static electricity must be taken when handling USB memory.

Inserting a USB Memory

Attach the USB memory to the USB memory terminal.

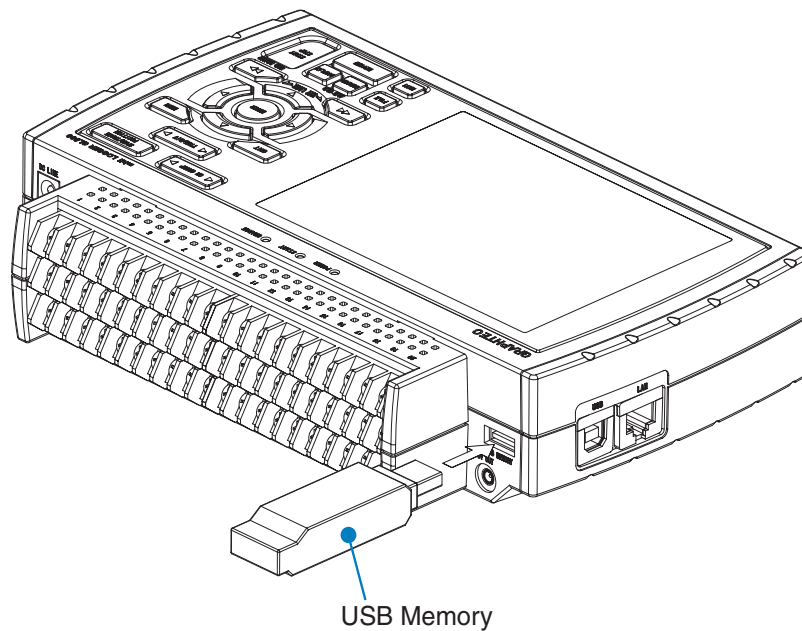

CAUTION

When you attach the USB memory to GL800, be careful during handling so as not to bump or drop the unit.

<Specifications of supported USB memory>

- Power source : +5 V
- Power consumption : 250 mA or below
- Capacity : No limit (except each file must be within 2 GB)

* USB memory with security functions such as fingerprint authentication cannot be used.

2.8 Connecting to a PC

Use the USB, LAN Interface to connect the GL800 to a PC.

Connection Using a USB Cable

Use the USB cable to connect the GL800 to a PC.

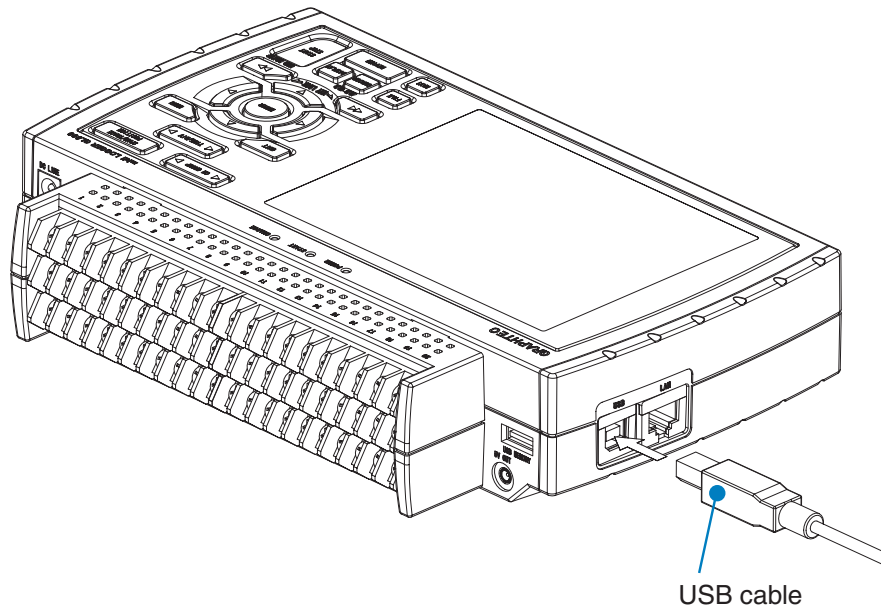

If the USB cable is used, the USB driver must be installed in your PC. Please refer to "Application Software Instruction Manual" for the installation procedure.

CAUTION

The USB connector is adjacent to the LAN connector. Make sure the cable is inserted into the correct connector.

LAN Connection

Use a LAN cable to connect the GL800 to a PC.

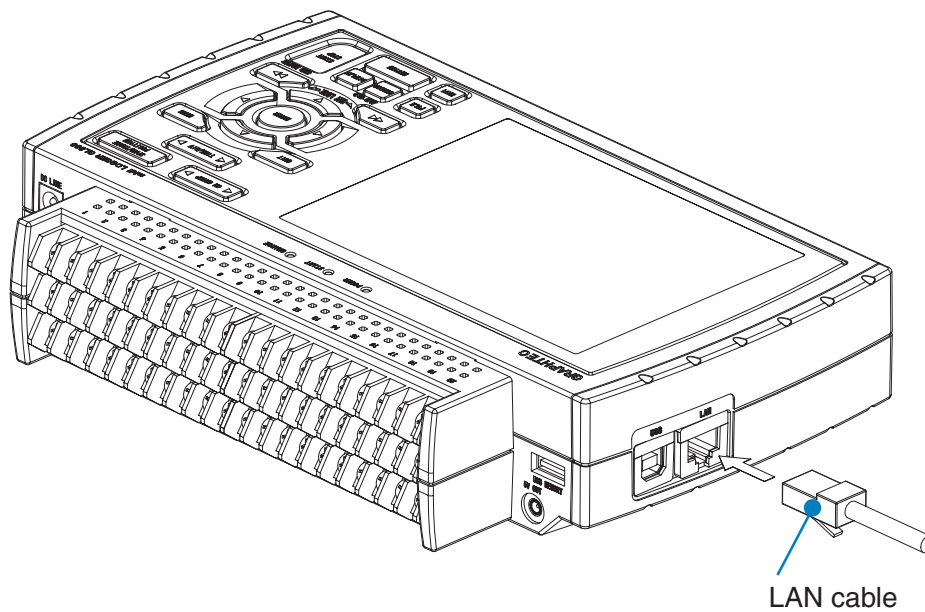

Cable Types

- Use a crossing cable when connecting directly to a PC, without using a hub.

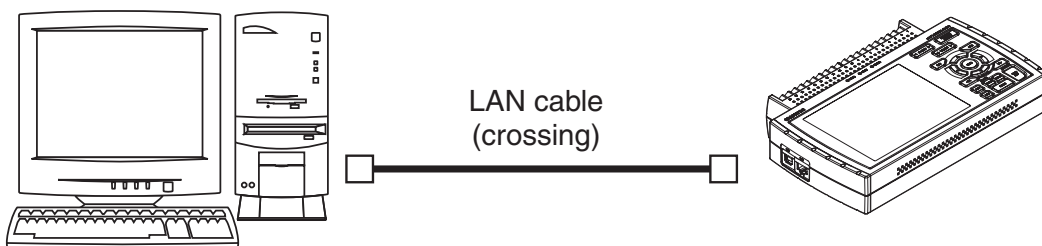

- Use a straight cable when using a hub.

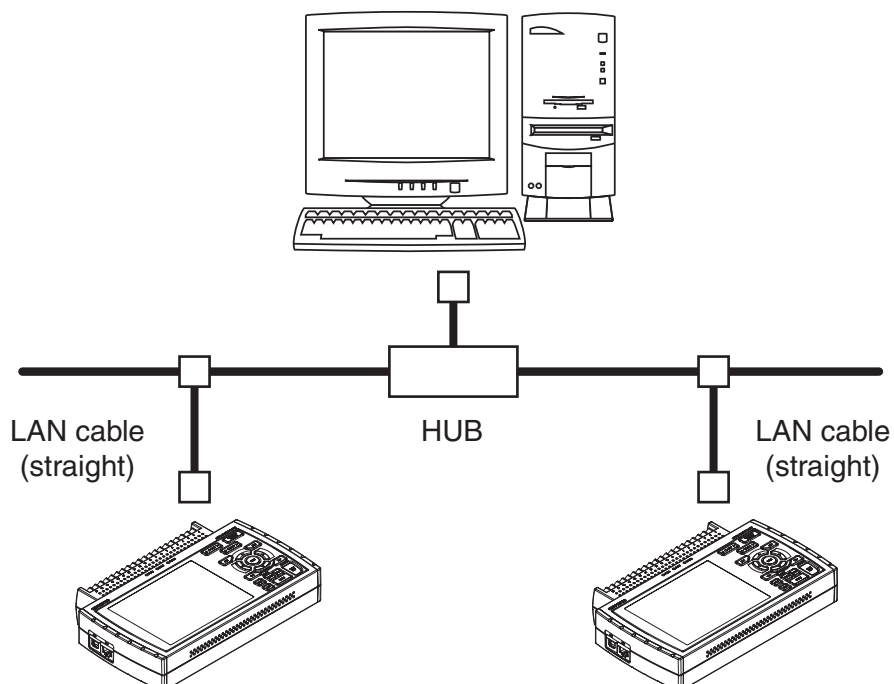

2.9 Using the Battery Pack (Option)

The B-517 battery is the only battery type that can be used with the GL800.

Mounting the Battery Pack

- (1) While lightly pushing the grip of the battery cover, slid the cover in the direction indicated by the arrow.

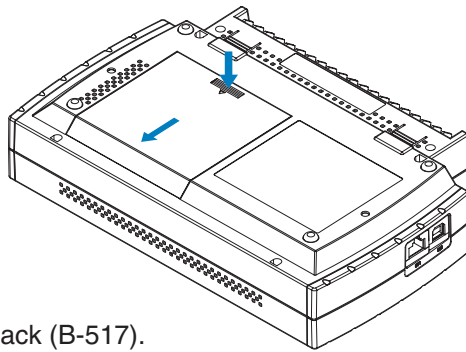

- (2) Attach the battery pack (B-517).

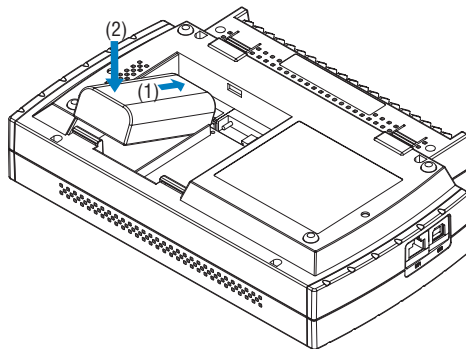

Either one or two battery packs can be attached.
To connect one pack, connect to either one of the connectors.
Attaching two battery packs allows longer operational time.

! CAUTION

When attaching two battery packs, make sure the battery levels are equivalent.
Do not use a new battery with an old battery at the same time.
When attaching two battery packs, make sure the remaining amount are same.
If you are not sure about the amount, charge each battery and then attach full-charged two battery packs.

- (3) Attach the battery cover.

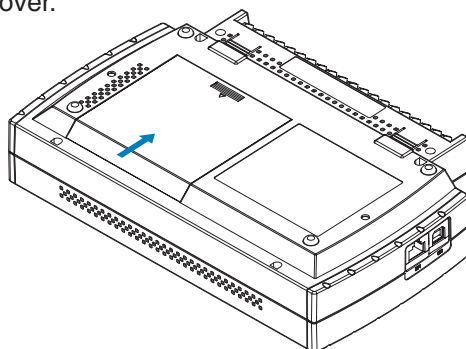

Charging the Battery

- Expected time required for charging:
- battery pack x 1: approx. 4 hours
 - battery pack x 2: approx. 8 hours

The battery pack is charged by mounting it in the GL800, attaching AC adapter to the GL800.

- (1) Mount the battery pack in the GL800 (see the previous section for the mounting procedure).
- (2) Turn on the power to the GL800. (Please see Section 2.4, "Connecting the Power Cable and Turning on the Power").
- (3) The CHARGE LED lights.

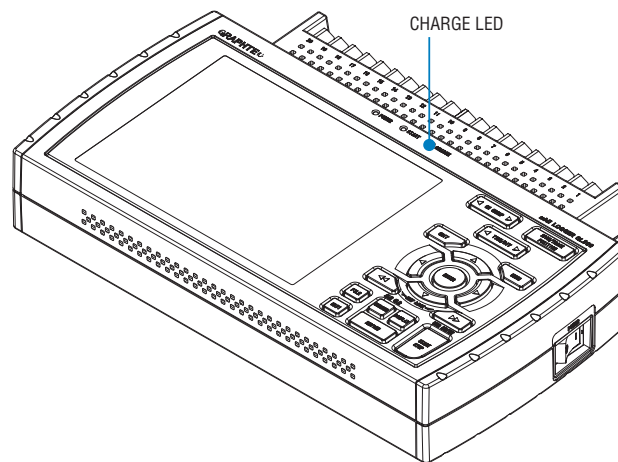

- GL800 is equipped with a temperature monitor function which starts automatic charging as soon as it is cooled down. Therefore, depending on the internal temperature, charging may not be performed immediately.
When charging is attempted while the power is ON, charging may not be performed immediately depending on the temperature environment.
In such a case, set the Screen Saver settings to ON. GL800 will start charging as soon as it is cooled down.
Charging temperature: 15 to 35 °C
 - If input is being made directly from the DC power supply instead of the AC adapter, the DC voltage must be at least approx. 16 V.
-

2.10 Connecting the Humidity Sensor (Option)

Connect the + and - lead wires of the humidity sensor (the B-530 option) to the desired terminals, and then insert the round connector into the 5V OUT connector on the GL800.

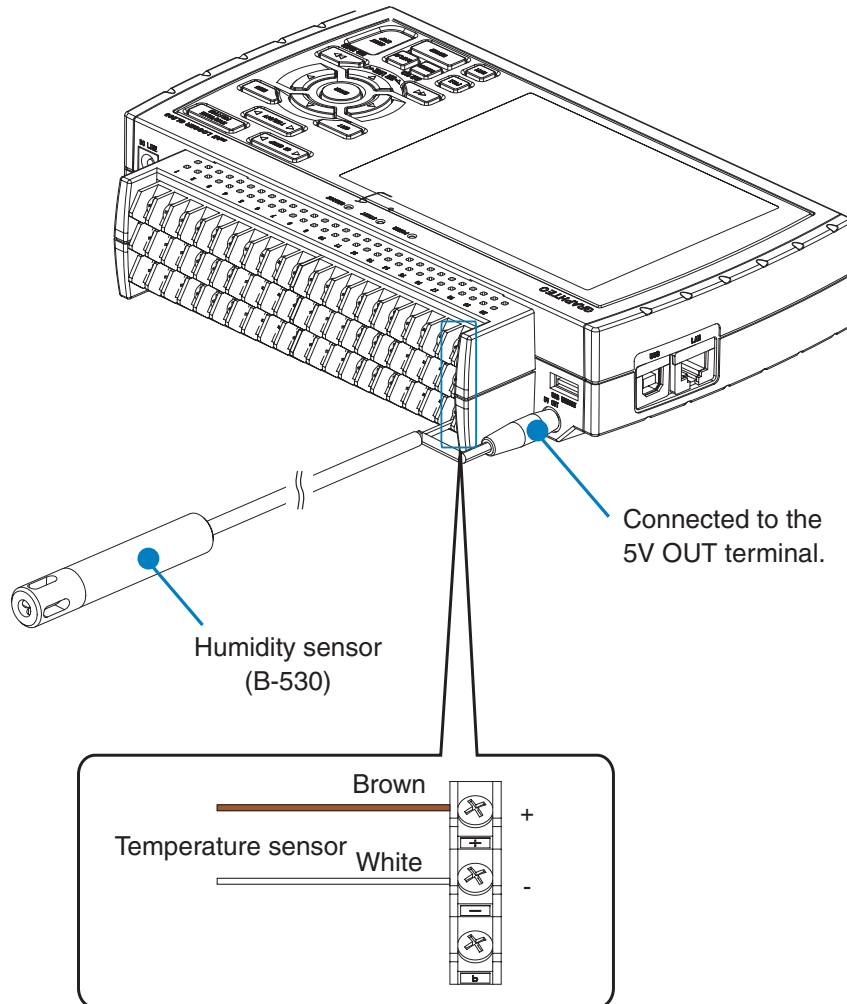

CAUTION

Do not use the sensor in a strong electrolyte environment. Measured results may not satisfy to the stated.

2.11 Mounting and Removing the Terminal Unit

Remove and mount terminal units as shown below.

⚠ CAUTION

Make sure the GL800's power is OFF when removing or mounting terminal units.

To Remove

Pull the terminal unit out towards the direction indicated by the arrow while pressing the two locks at the bottom of the unit.

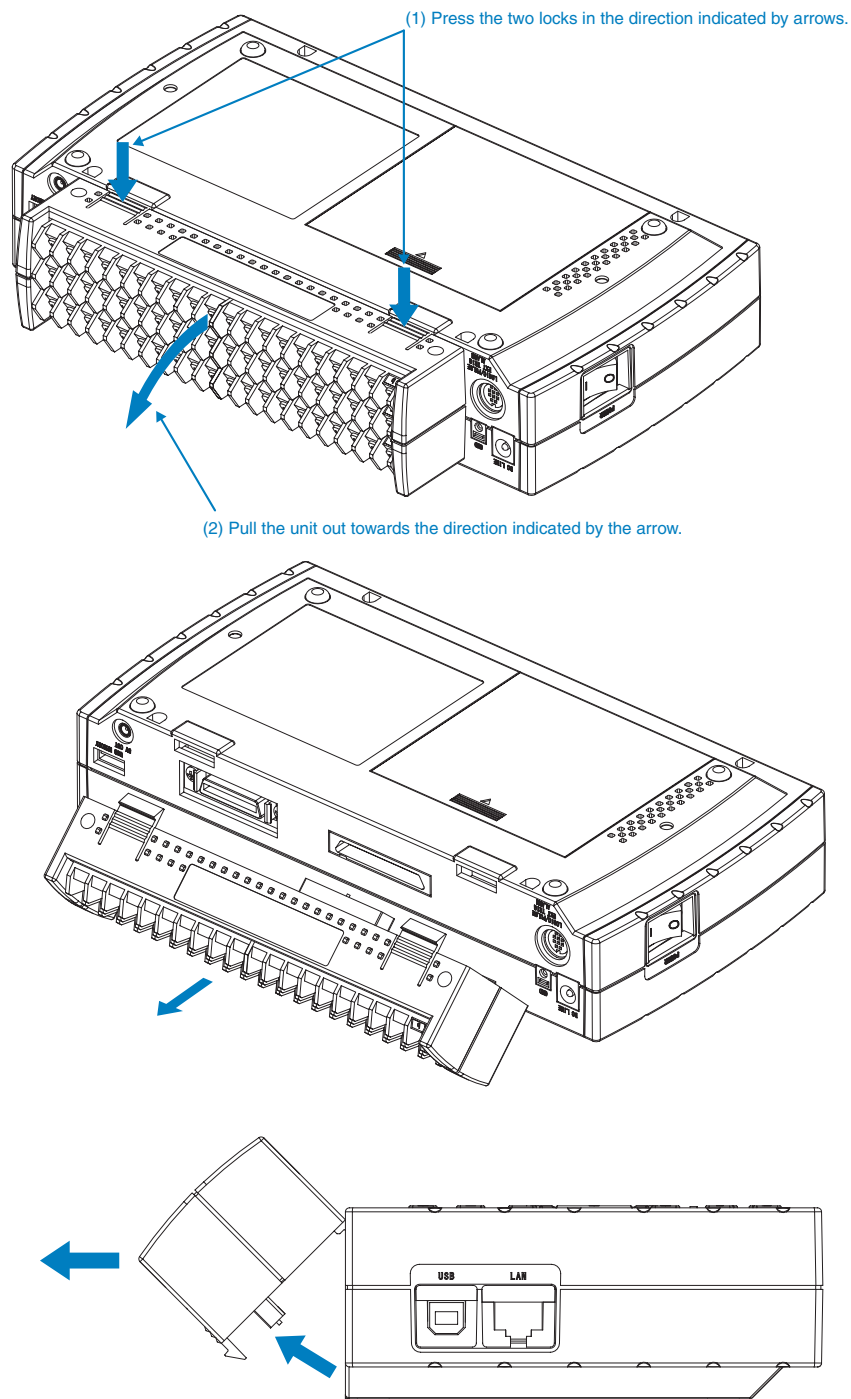

To Mount

Insert the tabs at the top of the terminal unit into the slots of the GL800, and push in the unit until the lock tabs at the bottom of the unit are securely locked.

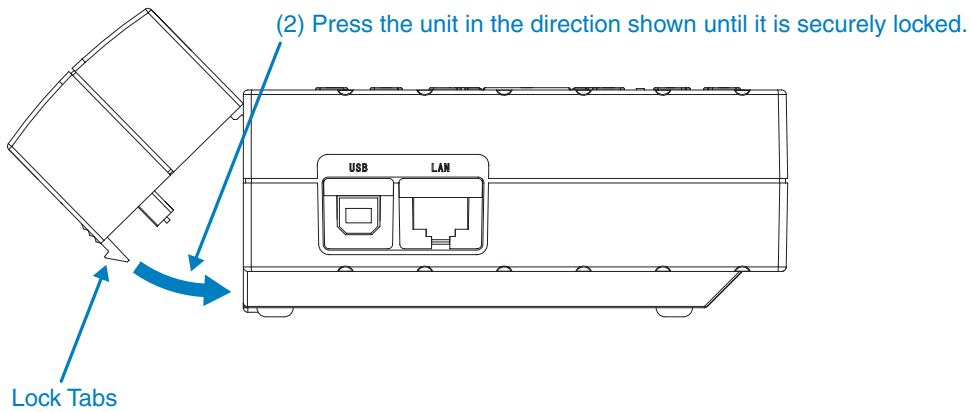
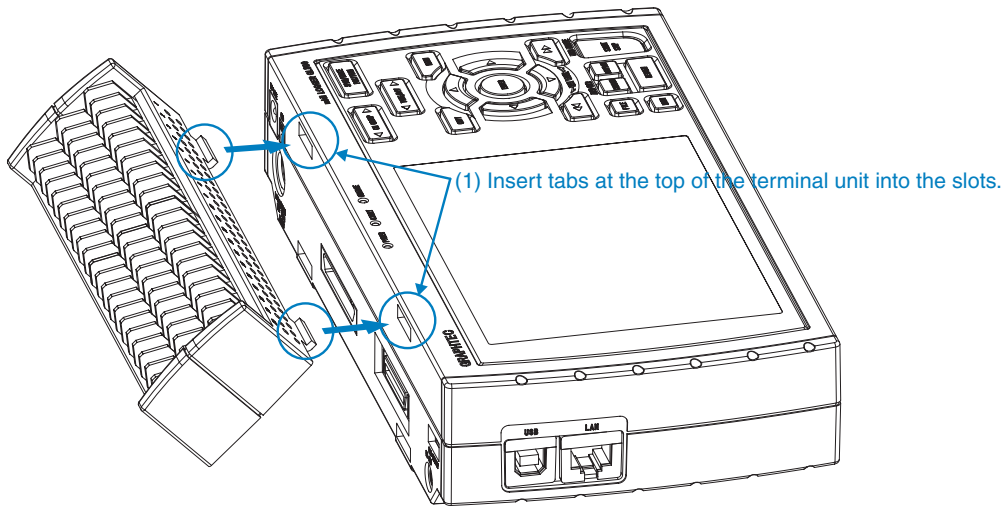

2.12 Mounting the Extension Terminal Base Set (B-537)

Mount the extension terminal base set as shown below.

CAUTION

Make sure the GL800's power is OFF when mounting the extension terminals.

B-537 Set Contents

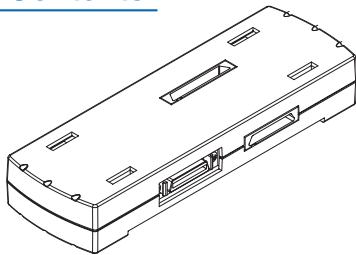

Extension Terminal Base Unit : 1

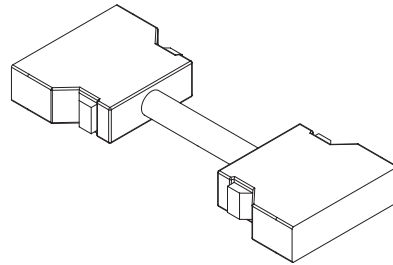

Extension Terminal Cable : 1

To Mount

- (1) Remove the terminal unit mounted to the GL800 (refer to 2-11).
- (2) Insert the tabs at the top of the terminal unit into the slots of the extension terminal base unit, and push in the unit until the lock tabs at the bottom of the unit are securely locked.

(1) Insert tabs at the top of the terminal unit into the slots of the extension terminal base unit.

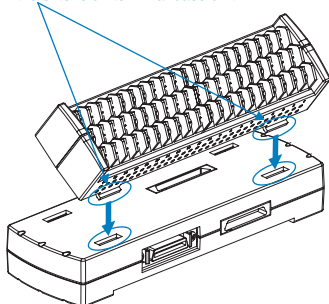

(2) Press the unit in the direction shown until it is securely locked.

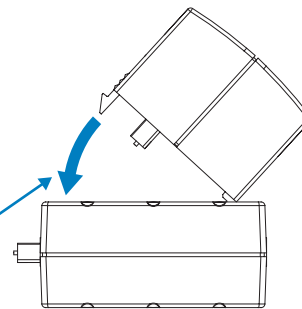

- (3) Connect the extension terminal cable to the extension terminal base unit.
* Press in the cable until it is securely locked.

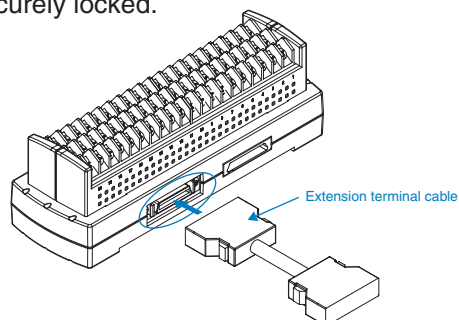

- (4) Connect the other end of the extension terminal cable to GL800.
* Press in the cable until it is securely locked.

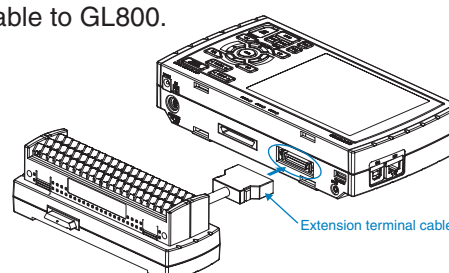

2.13 Mounting the 20 Channel Extension Terminal Set (B-538)

Mount the 20 channel extension terminal set as shown below.

CAUTION

Make sure the GL800's power is OFF when mounting the extension terminals.

B-538 Set Contents

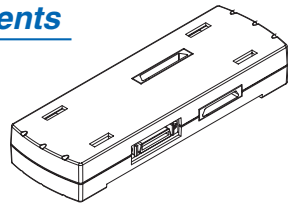

Extension Terminal Base Unit : 1

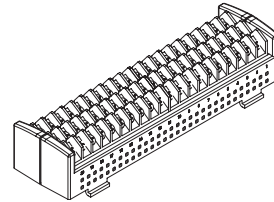

20 Channel Terminals : 1

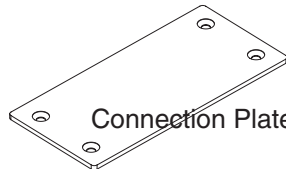

Connection Plate : 1



M4 x 6 Flat Head Screw : 4

To Mount

(1) Connect the extension terminal base unit connectors.

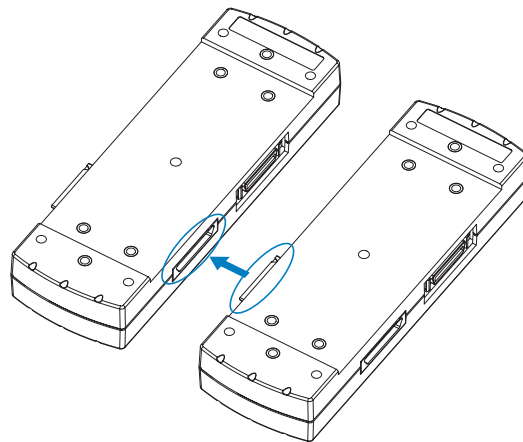

(2) Screw on the connection plate using attached screws.

* Recommended screw torque: 14 kgf/cm

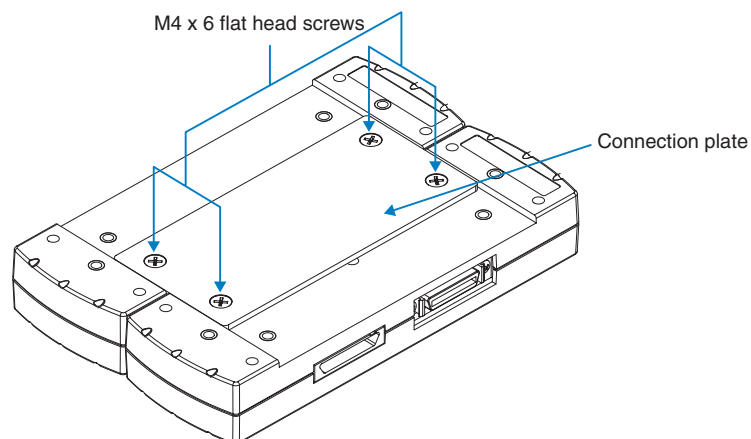

- (3) Connect the extension terminal cable to the extension terminal base unit.
 * Press in the cable until it is securely locked.

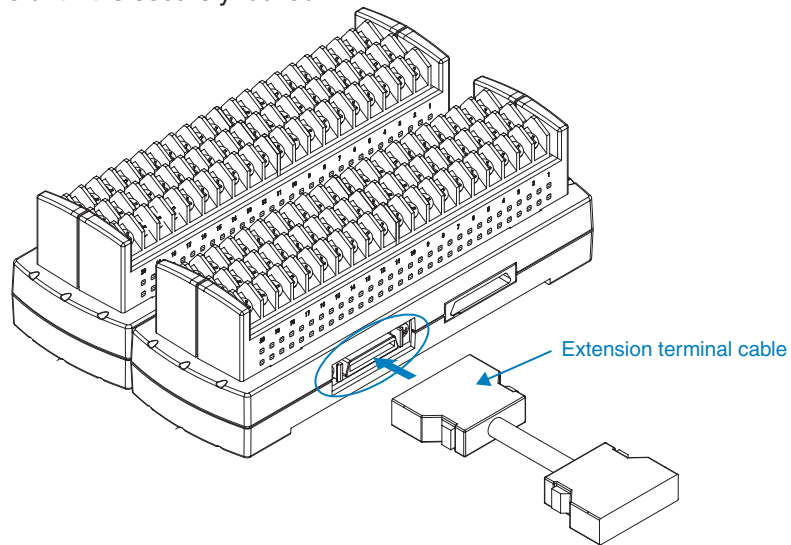

- (4) Connect the other end of the extension terminal cable to GL800.
 * Press in the cable until it is securely locked.

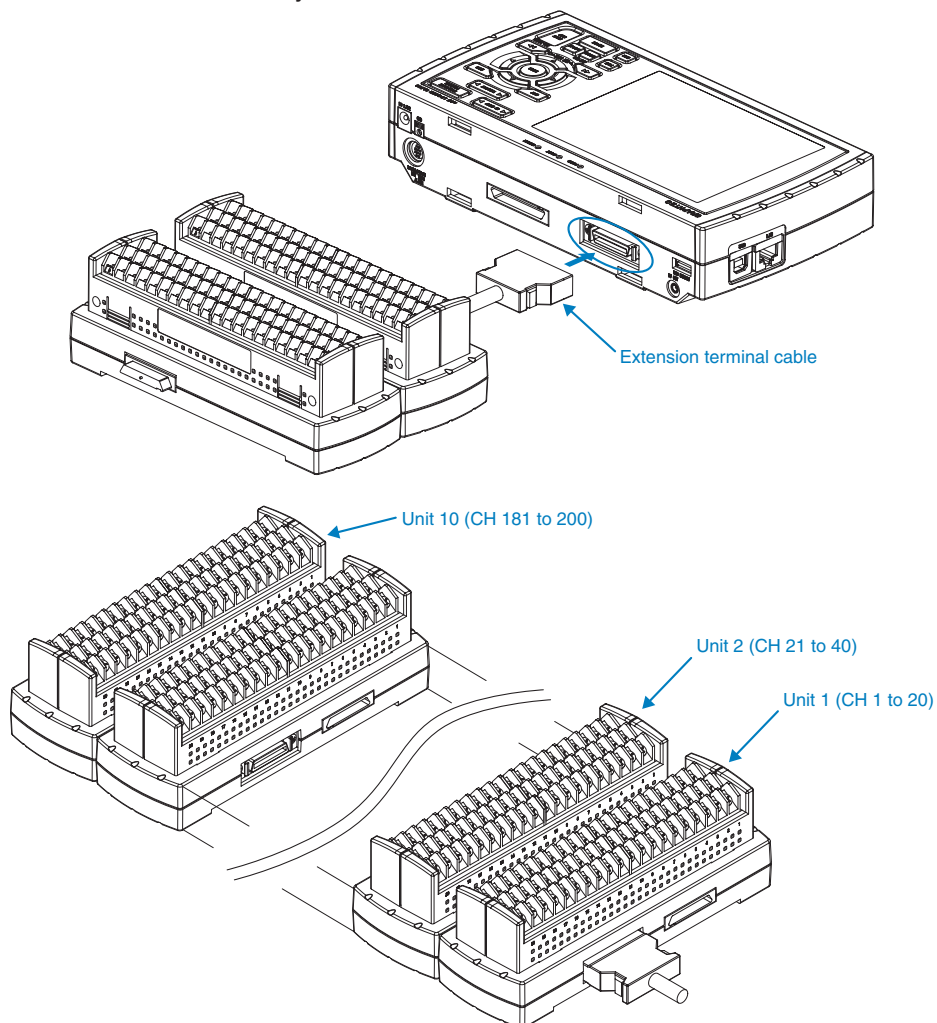

⚠ CAUTION

When connecting additional terminals, make sure they are added in a continuous manner. Any terminals omitted will prevent subsequent terminals from being recognized.

2.14 Precautions to Observe When Performing Measurement

Please be sure to read the following carefully in order to prevent electric shocks or shorts.

⚠ DANGER

- Do not apply voltage of AC30 Vrms or 60 VDC or above between the analog input section and main unit (GND terminal), or between each analog input channel.
- Do not apply radio-frequency signals with high voltage (50 KHz or above).
- Be sure to use only the AC adapter provided as a standard accessory. The rated power supply range for the adapter is 100 to 240 VAC, and the rated frequency is 50/60 Hz. Do not use any other voltages.

Input Circuit Diagram for Analog Input (Voltage, Thermocouples)

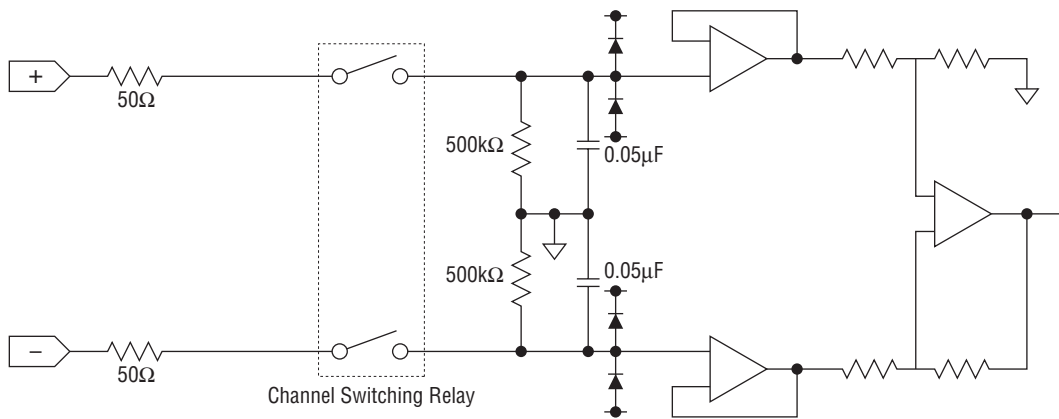

⚠ CAUTION

Capacitors have been incorporated into the input circuit to increase the noise elimination capability. After voltage measurement, when the inputs have been disconnected, there will still be some electric charge remaining. Before starting another measurement operation, short-circuit the + and - terminals to enable self-discharge.

The GL800 has a scan system.

While in the status (open) in which signals are not input to the input terminal, measured results may be influenced by signals from other channels.

In such a case, turn OFF the input setting or short circuit +/-.

If signals are input correctly, measured results are not influenced by other channels.

2.15 Noise Countermeasures

Be sure to connect the chassis GND of the object to be measured.

It may become effective by ensuring that the chassis GND wire of the measurement object is connected to a good ground.

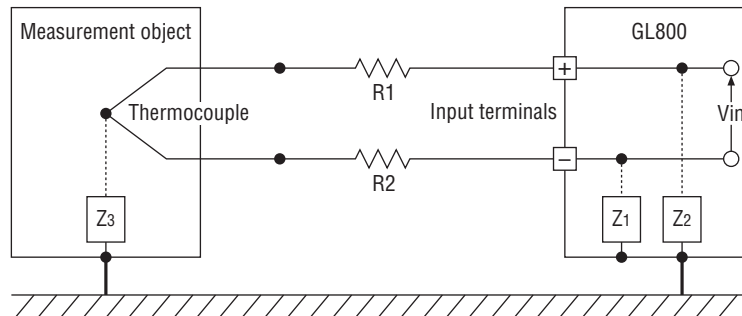

Connect the signal chassis GND and the measurement device chassis ground.

Use a short, thick lead to connect the chassis GND of the measurement object to the GL800' chassis GND. It will become even more effective if the ground potentials are the same.

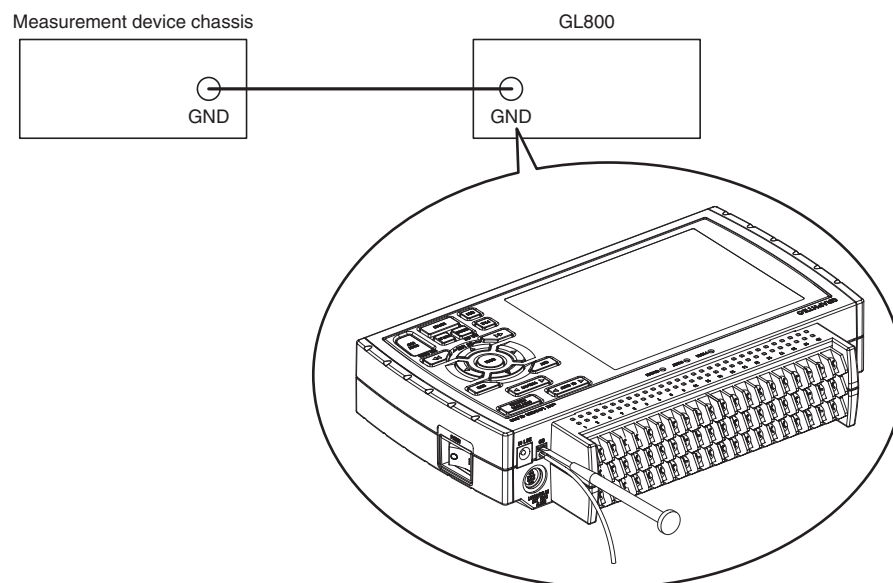

The effects of the digital filter function will vary depending on the number of terminal channels and sampling speed.

If measured values fluctuate due to noise, set the sampling speed to a value which enables the digital filter function.

See page 3-20 for details.

2.16 Setting the Date and Time

If you are using the GL800 for the first time, charge the internal rechargeable battery and then make the date and time settings.

 **CAUTION**

If the GL800 is not used for a period of approximately six months, the internal rechargeable battery may be discharged and the date and time may revert to the initial settings. If this happens, recharge the battery before using the GL800.

How to Recharge the Rechargeable Battery

Using the AC adapter provided, connect the GL800 to a mains power outlet, turn on the power switch, and then leave the GL800 connected for at least 24 hours.

How to Set the Date and Time

Press the [MENU] key, display the "OTHR" screen, and then set the date and time at the Date/Time Settings sub-menu. For details, see "Date/Time" on page 3-28.

CHAPTER 3

Settings and Measurement

This chapter describes the setting and measurement procedures for the GL800.

- 3.1 Window names and functions**
- 3.2 Key Operation**
- 3.3 Operation Modes**
- 3.4 Setting Menu**
- 3.5 WEB Server Function**

3.1 Window names and functions

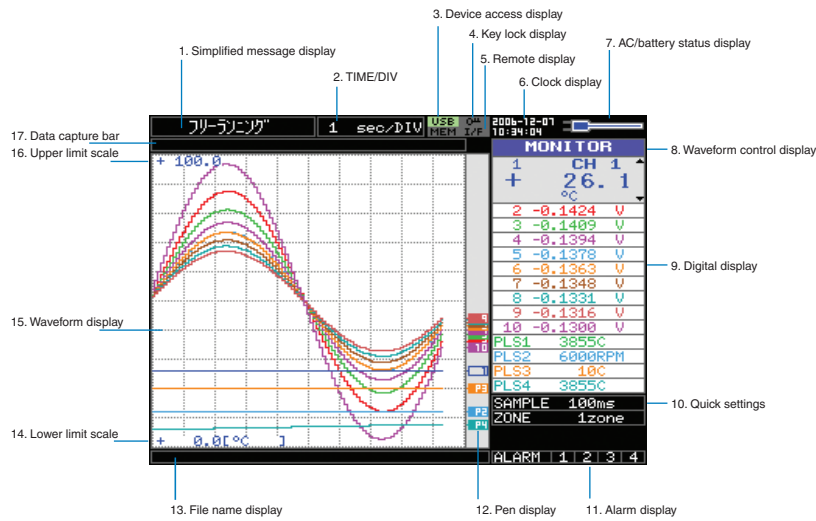

- 1. Simplified message display : Displays the operation status.
- 2. Time/DIV display : Displays the current time scale.
- 3. Device access display : Turns red when USB memory is accessed. When the internal memory is being accessed, the MEM lamp turns red.
- 4. Key lock display : Displays the key lock status. (Yellow = Locked)
- 5. Remote display : Lit when the GL800 is in remote mode (Yellow = Remote mode)
- 6. Clock display : Displays the current date and time.
- 7. AC/battery status display : Displays the icon when AC power is used and indicates the level when the battery is used.

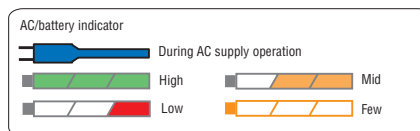

- 8. Waveform control display : Displays the mode when using the SPAN/TRACE/POSITION key to control the waveform.
- 9. Digital display : Displays the input value of each channel. Use the ∇/Δ key to select the channel you want to activate (enlarged display). The waveform of the active channel is displayed at the top.
- 10. Quick settings : Displays items available for easy operation. Use the ∇/Δ key to activate the Quick setting area and the $\langle \triangleright \rangle$ key to change values.
- 11. Alarm display : Displays the alarm output terminal status. (Red = Alarm generated issued)
- 12. Pen display : Displays the position of each channel signal, trigger and alarm range.

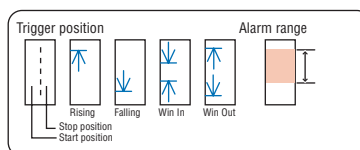

- 13. File name display : Displays the name of the file used to capture data.
- 14. Lower limit scale : Displays the lower limit scale of the currently active channel.
- 15. Waveform display : Displays the waveform of the input signal.
- 16. Upper limit scale : Displays the upper limit scale of the currently active channel.
- 17. Data capture bar : Indicates the remaining capacity of the capture media during data capture. During replay, indicates information about the displayed position.

3.2 Key Operation

This section describes key operation.

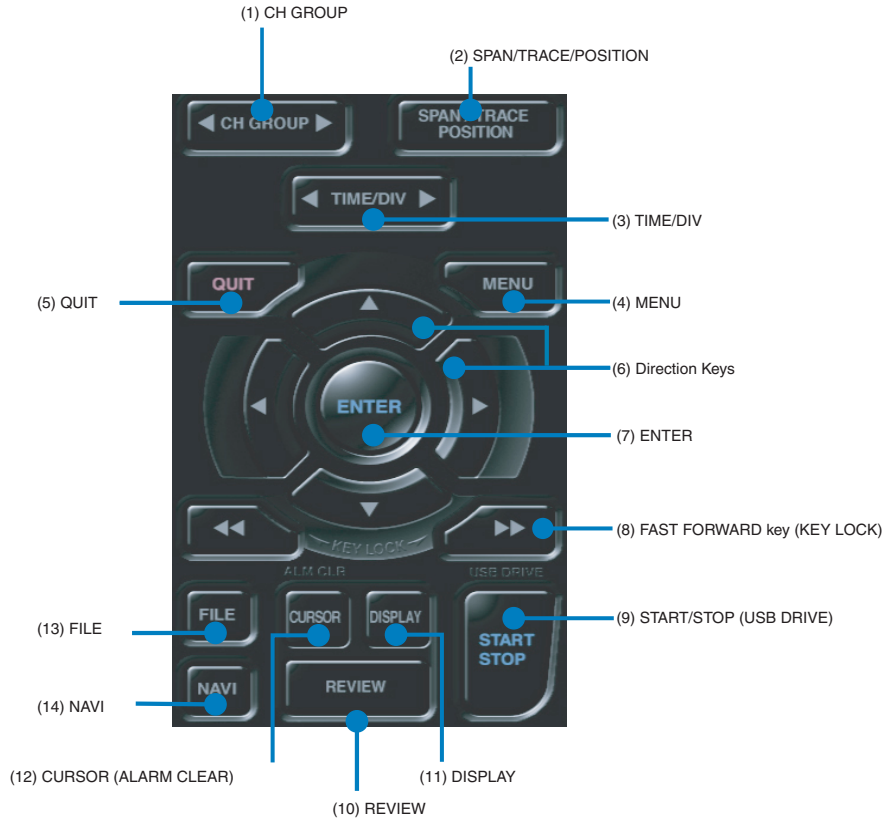

(1) CH GROUP

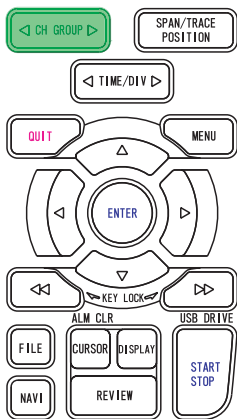

Press this key to switch to the next group consisting of 10 channels.

Press the ◀ side to switch to the group consisting of the next 10 channels with a smaller number.

Press the ▶ side to switch to the group consisting of the next 10 channels with a larger number.

Pressing this key can switch among the following items.

- Switch channels of the digital display area
- Switch channels of the AMP settings
- Switch channels of the trigger/alarm level settings
- Switch channels of the calculation display

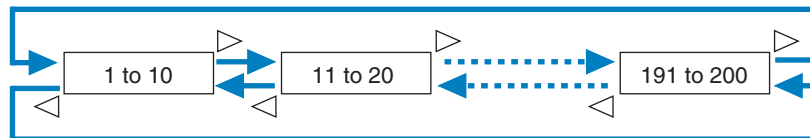

MONITOR

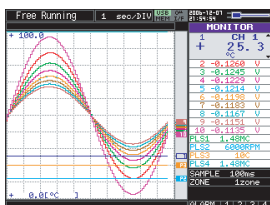

AMP settings

CH	Input	Range	Filter	EU	Misc.
1	TEMP	To-T	40	Off	▽
2	ADC	1 V	40	Off	▽
3	ADC	1 V	40	Off	▽
4	ADC	1 V	40	Off	▽
5	ADC	1 V	40	Off	▽
6	ADC	1 V	40	Off	▽
7	ADC	1 V	40	Off	▽
8	ADC	1 V	40	Off	▽
9	ADC	1 V	40	Off	▽
10	ADC	1 V	40	Off	▽

Level settings

CH	Mode	Lower-Level	Upper
1	Off		
2	Off		
3	Off		
4	Off		
5	Off		
6	Off		
7	Off		
8	Off		
9	Off		
10	Off		

Digital screen

CH	VALUE	RMS	Min
1	+ 25.5	+ 95.9	+ 99.4
2	+ 0.2323	+ 0.2668	- 0.3796
3	+ 0.2336	+ 0.2668	- 0.3796
4	+ 0.2348	+ 0.2668	- 0.3796
5	+ 0.2361	+ 0.2668	- 0.3796
6	+ 0.2374	+ 0.2668	- 0.3796
7	+ 0.2387	+ 0.2668	- 0.3796
8	+ 0.2399	+ 0.2668	- 0.3796
9	+ 0.2412	+ 0.2668	- 0.3796
10	+ 0.2424	+ 0.2668	- 0.3796

(2) SPAN/TRACE/POSITION

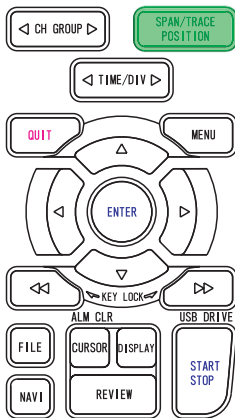

Switches the display in the digital display.

Used to change the settings related to waveform display during Free Running (when stopped), data capture and data replay.

Pressing this key will switch displays as shown below.

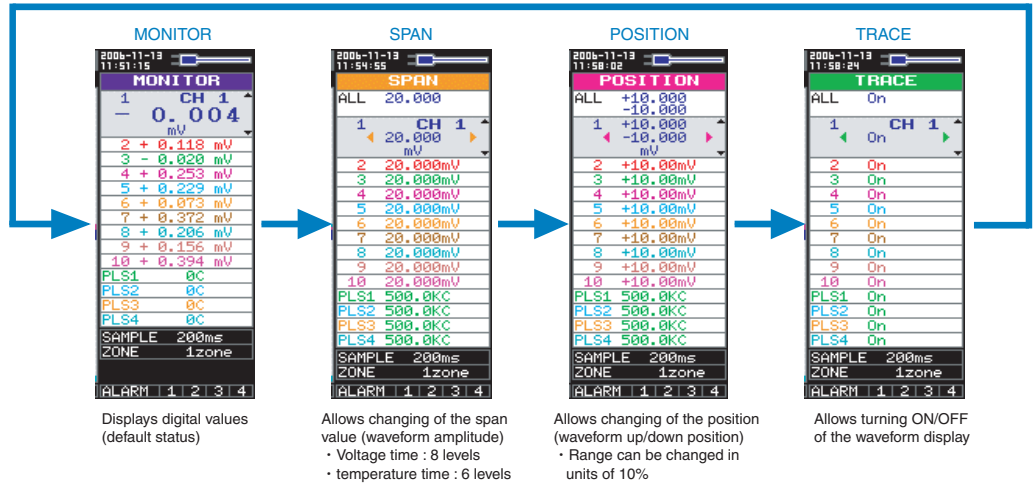

Setting Procedure

1. Select the item you want to change (SPAN/TRACE/POSITION key).
2. Use the ∇/Δ keys to switch the channels, and \leftarrow/\rightarrow keys to change the setting values.

When ALL is set, setting values for CH1 is reflected on other channels.

* When CH1 is OFF, ALL cannot be set.

(3) TIME/DIV

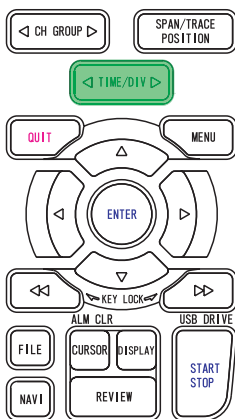

Press the left/right key of the TIME/DIV key to change the time axis display width.

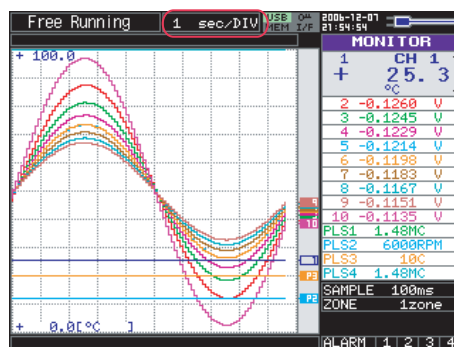

(4) MENU

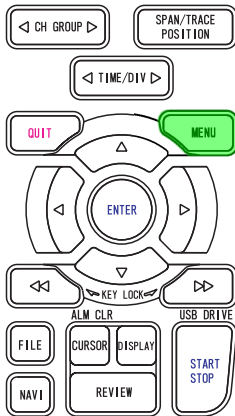

Open the settings window to capture data. For details on settings, see "3.4 Setting Menus".

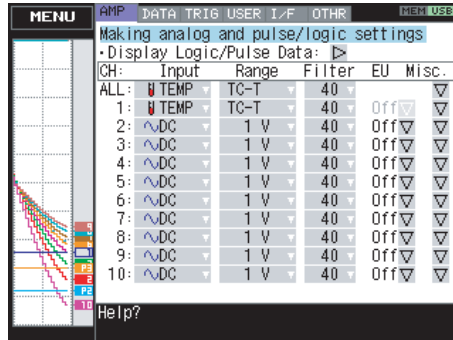

(5) QUIT (LOCAL)

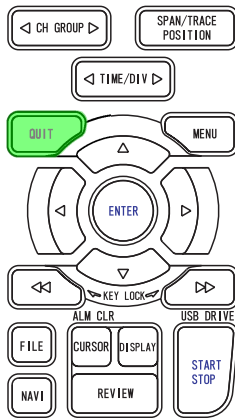

This key is primarily used for the following operations.

- To cancel a setting during menu configuration.
- To return to the MONITOR window when the SPAN/TRACE/POSITION window is displayed.
- To cancel remote status (in which keys are disabled) through interface control.
- To close the menu screen.
- To quit data replay.
- To return the Enlarged Waveform Screen/Digital + Calculation Display Screen to the Waveform + Digital Screen.

(6) Direction keys

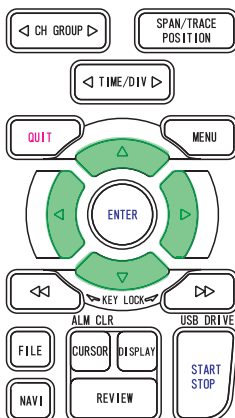

This key is primarily used for the following operations.

- To move a menu or setting item during menu configuration.
- To move the cursor during replay.
- To move the active channel in the Waveform + Digital screen (up/down keys).
- To change the setting of SPAN/TRACE/POSITION (left/right keys).

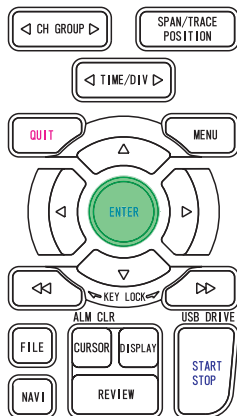
(7) ENTER

This key is primarily used for the following operation:

- To finalize setting items during menu configuration or open submenus.

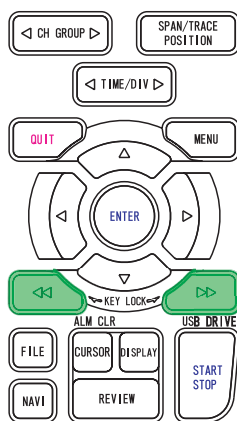
(8) FAST FORWARD key (KEY LOCK)

This key is primarily used for the following operations.

- To move the cursor at high speed during replay.
- To change the operation mode in the file box.
- To set key lock (Hold down the left/right FAST FORWARD key for at least two seconds. press again to unlock)

A password for canceling the key lock can be specified.
See page 3-37 for details.

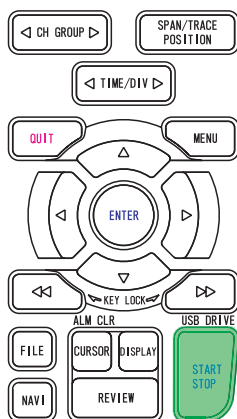
(9) START/STOP (USB Drive Mode)

Press this key to start or stop capture.

- During Free Running, starts capture.
- During capture, stops capture.

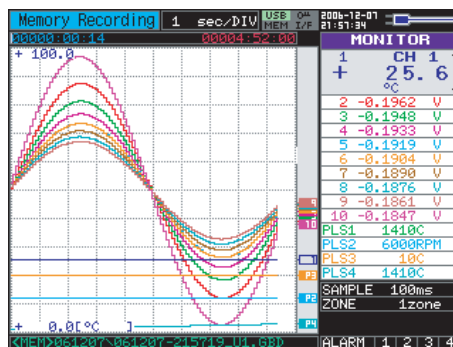

- Press this key while turning the power ON to access USB DRIVE Mode.

In USB Drive Mode, the internal memory is recognized by the PC as external storage media.

USB Drive Mode Operation Procedure

1. Use a USB cable to connect the GL800 and a PC.
(When the USB driver has not been installed, install it as described in the software manual "Installing the USB Driver".)
2. Connect the USB device to the GL800.
3. While pressing the GL800 START/STOP key, turn the power ON.
4. The external storage media is recognized by the PC and data exchange becomes possible.



(10) REVIEW

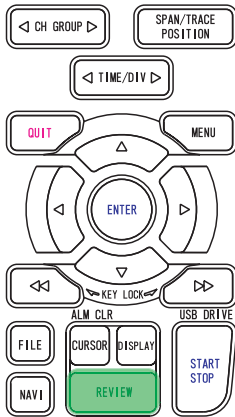

This key is used to replay captured data.

- During Free Running, replays captured data.
The screen used to specify the data replay source file appears; specify the file you want to replay.

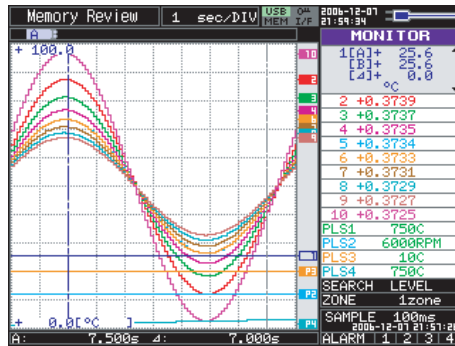

- While capturing data, recently captured data is replayed in two windows.

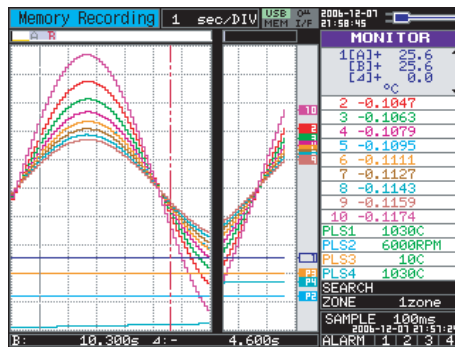

(11) DISPLAY

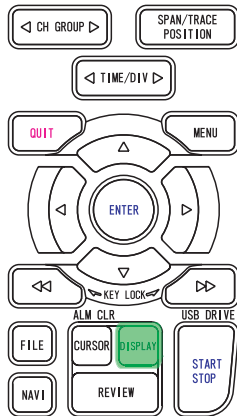

This key is used to switch the window mode.

You can switch the window mode during Free Running (when stopped) and Capturing.

Pressing this key switches the window display as follows:

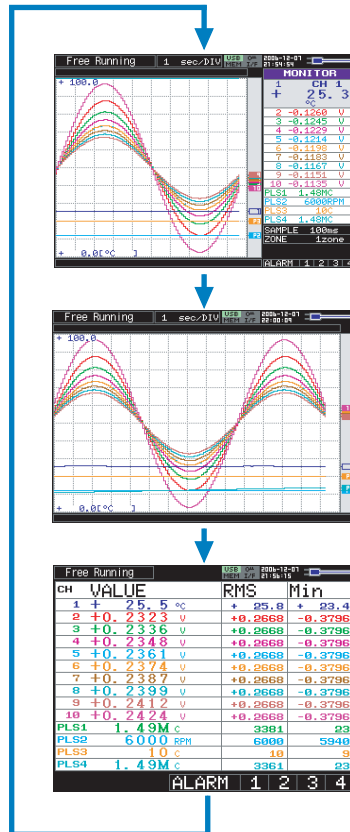

<Waveform + Digital Screen>
Default

<Expanded Waveform screen>
Displays the waveform in full screen mode.

<Digital + Calculation Display screen>
Displays digital values and calculation results in large text.

* Calculation results are added up in real time.

(12) CURSOR (ALARM CLEAR)

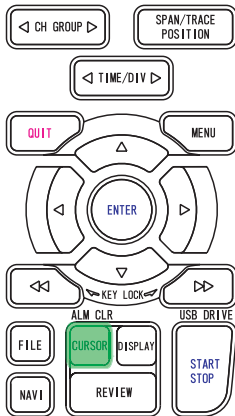

<When replaying captured data>

This key is used to toggle between cursors A and B during replay.

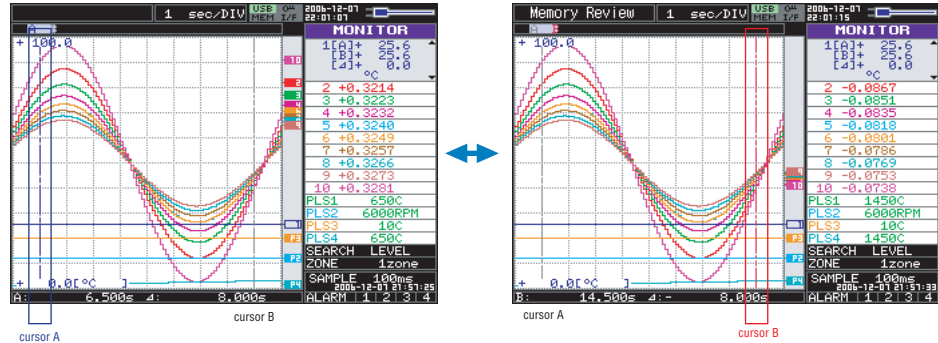

<When alarm generated>

When the alarm setting is "Hold generated Alarm", the maintained alarm is cleared.

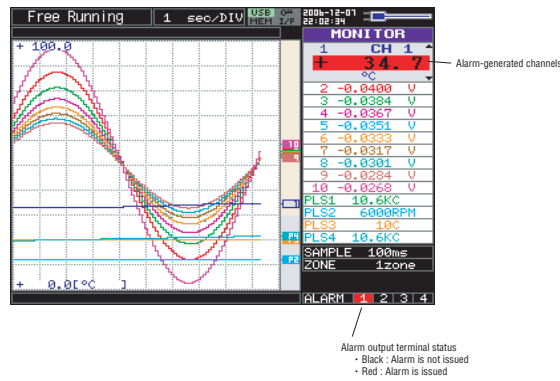

(13) FILE

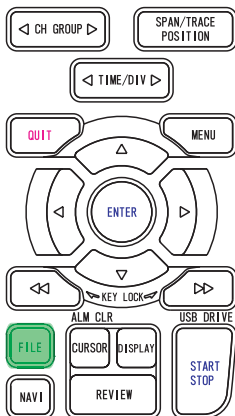

- This key is use for operations related to the Internal memory and USB device (copy and delete).
- Copies the window.
- Saves data between cursor A and cursor B during replay (can be set during replay only)
- Saves or reads the currently set condition into the USB device.

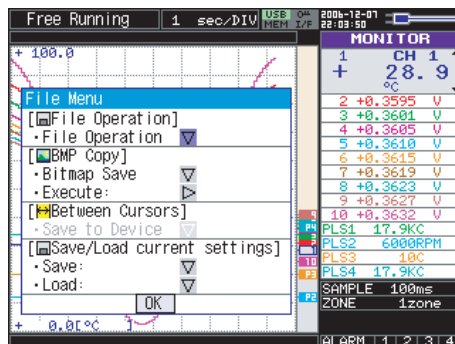

(14) NAVI

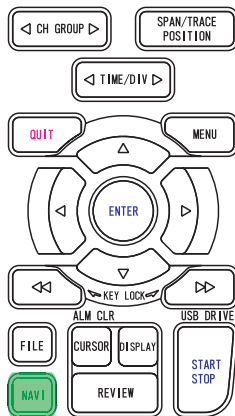

This key is used to display the key operation content during Free Running, capture or replay.

During display of the NAVI screen, an explanation of how the key is used is displayed in the window.

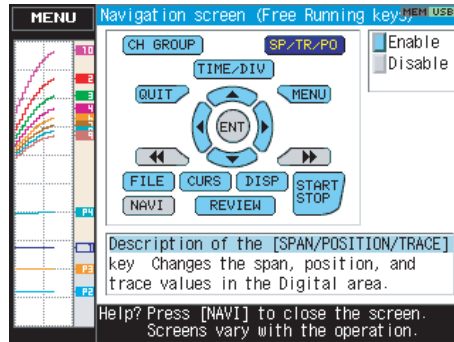

Basic Procedures Used in Settings

The following are basic operation procedures for settings.

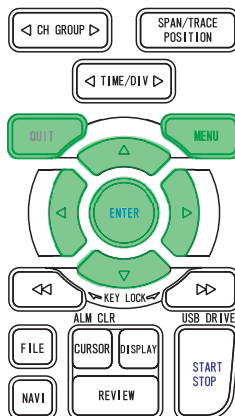

1. Press the MENU key to open each menu.
2. Use the $\nabla \Delta \langle \rangle$ key to move the cursor to the items you want to set.
3. Press the ENTER key to display a list of setting values.
4. Use the $\nabla \Delta \langle \rangle$ key to select a setting value.
5. Press the ENTER key to confirm the value.

The above operation is the basic procedure that may be used for each setting.

However, precise procedure may vary between setting items. Please follow the procedure indicated by each menu.

3.3 Operation Modes

You can check the system operation status in the simplified message display.

operation	operation	simplified message display
Free Running	Start up status or data is not being captured	Free Running
Capturing	Data is being captured in the main memory or USB device.	Memory Recording USB Drv Recording
Dual View Replaying	The current waveform display and data on capturing is being replayed	Memory Recording USB Drv Recording
Replaying	Captured data is being replayed	Memory Review USB Drive Review

Operation status transition

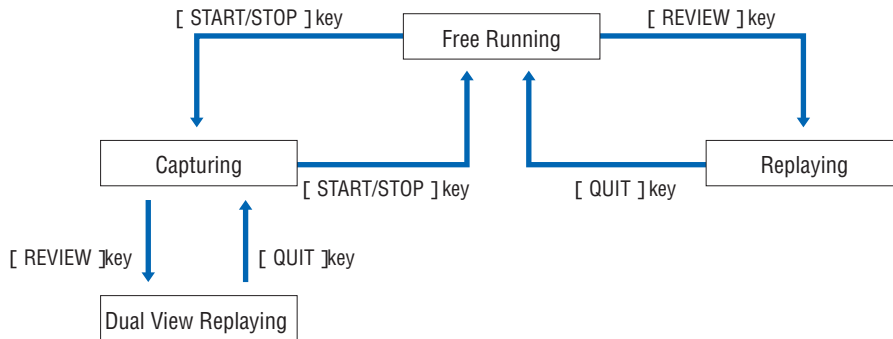

(1) Free Running

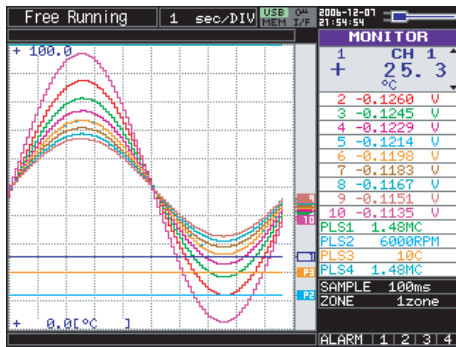

When in Free Running status, you primarily set up the system to capture data.

You can check the current input signal as a waveform or digital values.

Operations available during Free Running

Measurement parameters settings	The MENU key is used to change various setting items in configuration menus.
SPAN/TRACE/POSITION	The SPAN/TRACE/POSITION key is used to change settings.
Display mode	The DISPLAY key is used to change the display mode.
File operations	The FILE key is used to perform file-related operations.
Data replay	The REVIEW key is used to replay captured data.

(2) Capturing

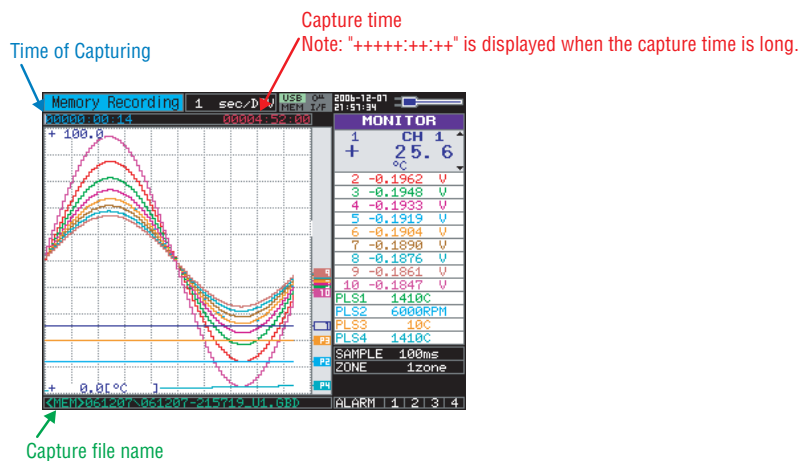

During data capture, data is captured into the Internal memory or USB device.

You cannot use the MENU key to change the setting.

Operations available during capture

SPAN/TRACE/POSITION	The SPAN/TRACE/POSITION key is used to change settings.
Display mode	The DISPLAY key is used to change the display mode.
Dual View replay	The REVIEW key is used to replay captured data in two windows at the same time.

(3) Dual View Replaying

Screen buffer usage rate (orange line)

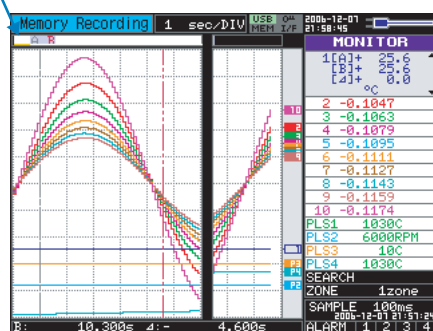

You can replay data during capture.

Waveform on the right side is the current captured data and the left side is previously captured data. You can use the Direction keys (left/right) to move the cursor to captured data to check digital values.

Operations available during dual view replaying

Moving cursor	The CURSOR key is used to switch between cursors A and B. The left/right or FAST FORWARD keys are used to move the cursors.
---------------	--

! CAUTION

Captured data can only be displayed for the double window buffer portion.
Dual view buffer capacity is 512 KB.

(4) Replaying

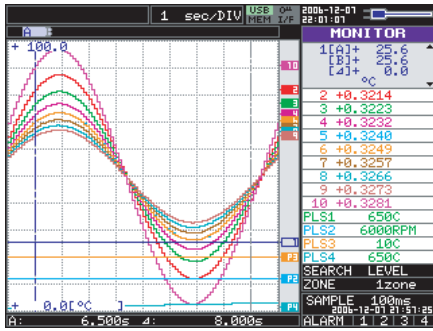

Displays captured data.

Available operation during replaying

SPAN/TRACE/POSITION	The SPAN/TRACE/POSITION key is used to change settings.
Menu operations during data replay	The MENU key is used to move the cursor, search data and set calculation.
Moving cursors	The CURSOR key is used to switch between cursors A and B. The left/right or FAST FORWARD keys are used to move the cursors
File operations	The FILE key is used to save the data between the cursors.

3.4 Setting Menus

When you press the MENU key during Free Running, the following menu screens appear.

The menu screens are classified by the tab for each setting item.

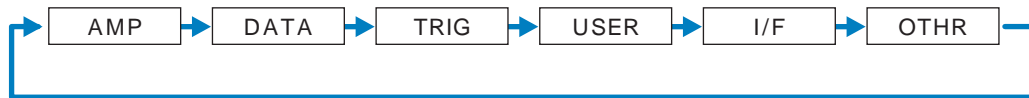

(1) AMP settings

This menu is used to specify input signal-related settings.

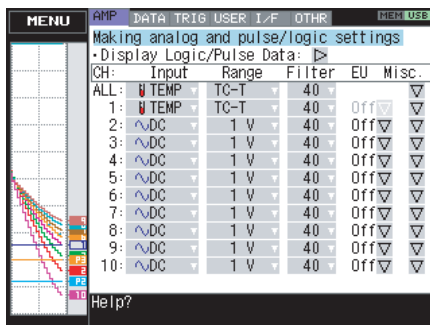

Setting	Selections available	
Input	Off, Voltage, Temperature, Humidity Humidity: (CAUTION: The voltage is compulsorily set to 1V, and the scaling function set to ON. 0V→0%, 1V→100%)	
Range	Voltage: 20, 50, 100, 200, 500 mV 1, 2, 5, 10, 20, 50, 1-5 V Temperature: TC-K, TC-J, TC-T, TC-R, TC-E, TC-B, TC-S, TC-N, TC-W, PT100, JPT100, PT1000	
Filter	Off, 2, 5, 10, 20, 40	
EU (Scaling settings)	Function	Off, On (effective when On has been selected)
	Lower – Upper	Settings
	Unit	Meas. Value (Upper/Lower) EU Value (Upper/Lower) Dec pt Unit Select
	Misc.	Span setting (Span All Settings) Annotation setting Zero voltage adjustment Perform Auto Zero ADJ. Reset Auto Zero ADJ. [Zero point voltage value]
Logic/Pulse	Off, Logic, Pulse	
	Logic Filter: Off, On Pulse Input: Off, Revolution counts, Counts, Inst. Filter: Off, On Slope: H, L Function: Off, On Measured values settings EU output value settings Unit settings	

Switching displays

Analog and logic/pulse can be switched as shown below.

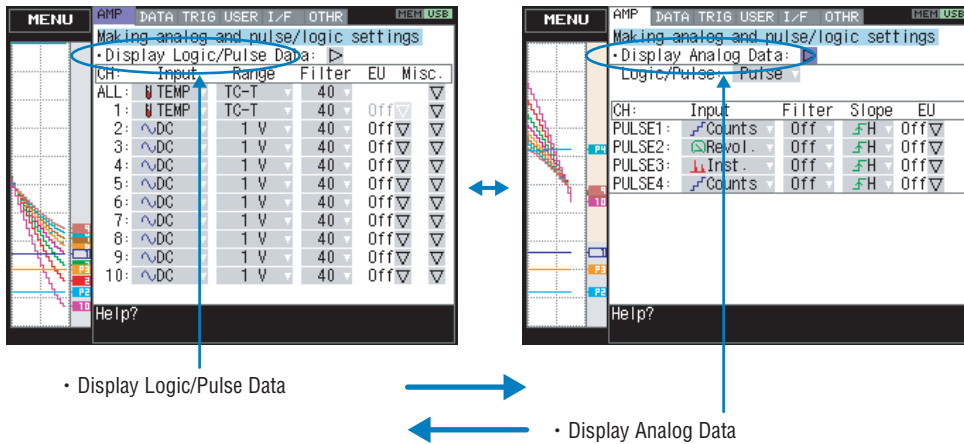

Analog settings

When you use CH ALL to set an input range and filter, all channels are set to the same settings if the input is the same. Range is set only for the same input CHs.

Span All Settings, is set only for the same range CHs.

CAUTION

ALL and Span All Settings are set only for the currently displayed group (per 10 channels).

- Input Selects input condition.
 - Off : No signal input is accepted.
 - Voltage : Used for measuring direct-current voltage.
 - Temperature : Used for measuring temperature.
 - Humidity : Used for measuring humidity.
- Range Specifies the range of signal input to be measured.
 - Voltage : 20, 50, 100, 200, 500mV, 1, 2, 5, 10, 20, 50, 1-5V
 - Temperature : TC-K, TC-J, TC-T, TC-R, TC-E, TC-B, TC-S, TC-N, TC-W, PT100, JPT100, PT1000

Available SPAN Settings

<Voltage Ranges>

Range	Maximum SPAN	Minimum SPAN	Minimum Resolution
20mV	-22.000 to +22.000mV	0.200mV	0.001mV
50mV	-55.00 to +55.00mV	0.50mV	0.01mV
100mV	-110.00 to +110.00mV	1.00mV	0.01mV
200mV	-220.00 to +220.00mV	2.00mV	0.01mV
500mV	-550.0 to +550.0mV	5.0mV	0.1mV
1V	-1.1000 to +1.1000V	0.0100V	0.0001V
2V	-2.2000 to +2.2000V	0.0200V	0.0001V
5V	-5.500 to +5.500V	0.050V	0.001V
10V	-11.000 to +11.000V	0.100V	0.001V
20V	-22.000 to +22.000V	0.200V	0.001V
50V	-55.00 to +55.00V	0.50V	0.01V
1-5V	-5.500 to +5.500V	0.050V	0.001V

<Temperature Ranges>

Range	Maximum SPAN	Minimum SPAN (p-p)	Measurement Range	Minimum Resolution
K	-270 to +2000°C	50°C	-200 to +1370°C	0.1°C
J	-270 to +2000°C	50°C	-200 to +1100°C	
T	-270 to +2000°C	50°C	-200 to +400°C	
R	-270 to +2000°C	50°C	0 to +1600°C	
E	-270 to +2000°C	50°C	-200 to +800°C	
B	-270 to +2000°C	50°C	+600 to +1820°C	
S	-270 to +2000°C	50°C	0 to +1760°C	
N	-270 to +2000°C	50°C	0 to +1300°C	
W	-270 to +2000°C	50°C	0 to +2315°C	
PT100	-270 to +2000°C	50°C	-200 to +850°C	
JPT100	-270 to +2000°C	50°C	-200 to +500°C	
PT1000	-270 to +2000°C	50°C	-200 to +500°C	

<Humidity Range>

Range	Maximum SPAN	Minimum SPAN (p-p)	Minimum Resolution
	0 to +110%	1.0%	0.1%

- Filter Sets the filter status. Please set the filter to ON when there is likely to be noise in the input. Filter operation is on a moving average basis. Off, 2, 5, 10, 20, 40
- EU (Scaling) Scales the measured values and converts them to other units.
- Function Sets the function to Off or On.
- Upper, Lower, Unit Sets the EU function's conversion value and unit.

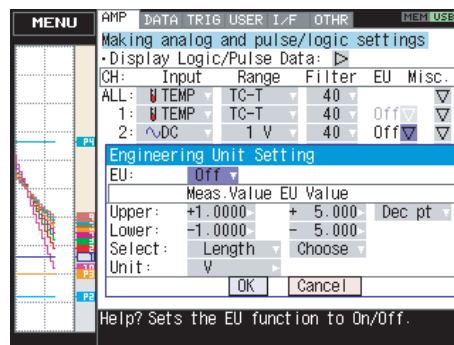

If this message appears, follow the instructions by reducing the number of digits to be output by one, or leaving the number of digits as is and changing the EU value.

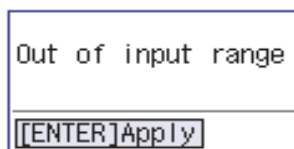

CAUTION

The Scaling operation is calculated using a ratio of the Meas. Value or EU Output Value settings. “++++/----” is displayed when the converted value cannot be processed by GL800.

- (a) Meas. Value
Specifies the numeric value to be converted. Set two points, the Upper and Lower parameters.

- (b) EU Value
Specifies output after conversion. Set two points, the Upper and Lower parameters.
- (c) Dec pt
This parameter specifies the decimal point position of the numeral to be specified as the EU value(s).
- (d) Unit
Selects the converted unit, which can be specified as a user-defined character string consisting of alphanumeric characters. The Unit parameter can also be specified by selecting the Select Unit setting.
- (e) Select
Selects the type of engineering unit.
- (f) Choose
Selects the converted unit. The Unit displayed here is the type of unit selected by the Select setting.

To specify a unit that is not displayed here, specify a user-defined character string as the Unit setting. Moreover, the setting specified here is displayed as the Unit setting.

Setting Example

	Upper Value	Lower Value
Specified Value	+2.5000	-2.5000
EU Value	+10.000	-10.000

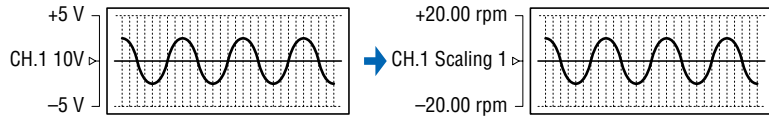

Misc. Span : Set the detailed span for each channel.

Annotation : Set a comment for each channel.

(For details , see the text input on page 3-33.)

Perform Auto Zero ADJ: Moves the current input voltage to zero position voltage value.

Reset Auto Zero ADJ : Cancels the zero position voltage value and displays input voltage.

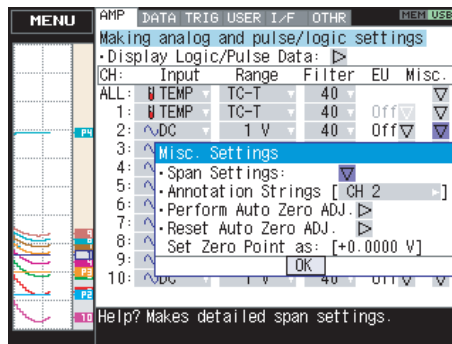

Logic and Pulse settings

Logic/Pulse Switching Switches the digital input.

- Off: Digital input is disabled.
- Logic: Digital input is processed as logic signals.
- Pulse: Digital input is processed as pulse signals.

Filter..... Sets the filter for digital input.

- Off: Disables filter circuit for digital input.
- On: Enables filter circuit for digital input.
Filter is approximately 30 Hz (-3 dB).

Pulse Input..... Sets the pulse input method for each channel.

- Off: Pulse input is disabled.
- Revol.: Counts the number of pulses per second and displays the value multiplied by 60 as rpm values.
- Counts: Displays the cumulative number of pulses for each sampling interval from the start of measurement.
- Inst.: Displays the number of pulses for each sampling interval.

Pulse Slope..... Sets the slope (direction) to count the number of pulses.

- H: Counts the rising pulse.
- L: Counts the falling pulse.

Pulse EU..... Sets scales for pulse measurement values.

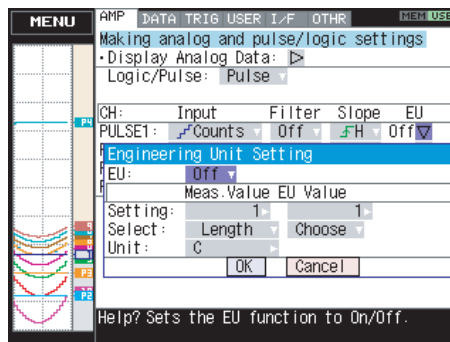

- Function: Sets On/Off of the Scaling function.
- Meas. Value: Specifies the numeric value to be converted.
- EU Value: Specifies output after conversion.
- Unit: Selects the converted unit, which can be specified as a user-defined character string consisting of alphanumeric characters. The Unit parameter can also be specified by selecting the Select Unit setting.
- Select: Selects the type of engineering unit.
- Choose: Selects the converted unit. The Unit displayed here is the type of unit selected by the Select Unit setting.

DATA settings

This menu is used to specify capture-related items and calculations.

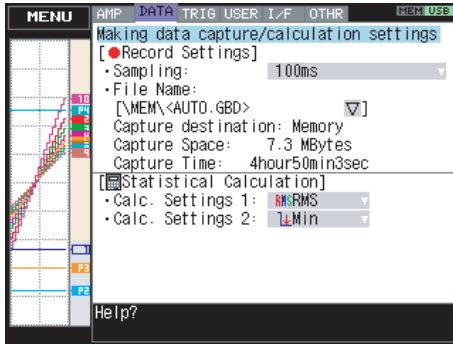

DATA Menu Structure

Setting	Selections available
Record Settings	100, 200, 500ms 1, 2, 5, 10, 20, 30s
• Sampling Interval	1, 2, 5, 10, 20, 30min, 1h
File Name	<ul style="list-style-type: none"> • File: Folder name, file name • Name Type: Auto, User • File Type: GBD, CSV
Statistical Calculation	Off, Average, Max, Min, Peak, RMS
• Function 1, 2	

CAUTION

When you save files, create a folder and then save the files in the folder. Regardless of the remaining capacity, if you try to save files in the root directory, due to file restrictions you may not be able to save files. The displayed Capture Time may vary according to the sampling interval or number of capture channels.

Sampling Interval Specifies the sampling interval for data capture.

The table below shows the number of measuring channels and sampling interval values that can be set.

If data fluctuate due to noise, set the sampling interval to a value which enables the digital filter function.

Number of Measuring Channels*	Allowed Sampling Interval	Sampling Interval which enables Digital Filter
10 channels or less	100 ms or above	500 ms or above
11CH to 20CH	200ms or above	1s or above
21CH to 50CH	500ms or above	2s or above
51CH to 100CH	1s or above	5s or above
101CH to 200CH	2s or above	10s or above

* "Number of Measuring Channels" is the number of channels in which input settings are NOT set to "OFF".

CAUTION

To use the digital filter function, you must set the AC power supply frequency accurately. Follow the instructions on page 3-28 to ensure that the settings are accurate.

Captured data file name Select the name of a file to which you want to save captured data. Set either the main memory or USB device (option). (See the file box on page 3-31.)

- Name Type Set how the file is named.
- Auto: Automatically uses the capture start time as the file name.
Example: 20050101-123456_UG.GBD
 - Number part: Created on January 1, 2005, 12: 34:56.
 - UG part: Number of user capturing data
UG: Guest
U1: User 1
U2: User 2
(For details on user setting, see “USER settings” on page 3-25.)
 - User: Captures data using a user-defined name.
- File Format..... Set the file format in which data is saved.
- GBD: Binary format
 - CSV: EXCEL format (such data cannot be replayed with the GL800)
- Statistical calculation Two types of operation can be performed on all channels.
Operation results are displayed on the Digital + Calculation Display screen.
- Off: Calculation is not performed.
 - Average: Displays the simple average value during data capture.
 - Max: Displays the maximum value during data capture.
 - Min: Displays the minimum value during data capture.
 - Peak: Displays the peak value data during data capture.
 - RMS: Displays the effective value of the data during data capture.

$$R.M.S = \sqrt{\sum D^2/n}$$

D: data n: number of data

TRIG settings

This menu is used to specify trigger conditions and alarms.

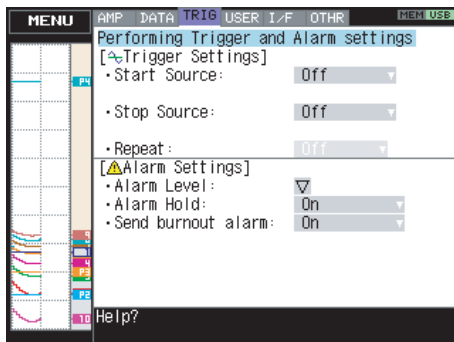

Setting	Selections available
Start side source setting	Off, Level, Alarm, External Input, Date
	Level : Mode, Level, Combination
	Alarm : Alarm port number
	External input : none
	Date : Date, Time
Stop side source setting	Off, Level, Alarm, External Input, Date, Time
	Level : Mode, Level, Combination
	Alarm : Alarm port number
	External input : none
	Date : Date, Time Time : Duration
Repeated capturing	On, Off
Alarm level settings	Mode, Level, Output
Alarm Hold	On, Off
Send burnout alarm	On, Off

- Start side source settings ... Specifies conditions to start data capture.
- Off: Starts capturing data unconditionally.
 - Level: Starts capturing data when a specified level is reached.
 - Alarm: Starts capturing data when the alarm with the specified number is generated.
 - External Input: Starts capturing data when an input signal is received from an external trigger terminal.
 - Date: Starts capturing data when a specified time arrives (when repeated capturing is set to Off)
: Starts capturing data when a specified time arrives (when repeated capturing is set to On)
This setting is used when you want to start capturing data at the same time every day.
- Stop side source settings Specifies conditions to stop data capture.
- Off: Does not stop data capture by a trigger.
 - Level: Stops data capture when the specified level is reached.
 - Alarm: Stops capturing data when the alarm with the specified number is generated.
 - External Input: Stops capturing data when an input signal is received from an external trigger terminal.
 - Date: Stops capturing data when a specified time arrives (when repeated capturing is set to Off).
: Stops capturing data when a specified time arrives (when repeated capturing is set to On).
This setting is used when you want to stop capturing data at the same time every day.
 - Time: Stops capturing data at a specified time after starting data capture.
- Repeated capturing After a stop side trigger is generated, the next data capture process begins.
- Off: Does not repeat data capture.
 - On: Repeats data capture.
- Alarm level settings When the setting level conditions are met, the alarm output terminal outputs an alarm.
The Digital screen showing the channel for which the alarm has been generated is displayed in red.
- Alarm Hold Specifies whether or not to maintain the alarm status when an alarm is generated and then canceled.
- Not Maintained: Alarm status is canceled when the alarm is canceled.
 - Maintained: Alarm status is not canceled even though the alarm is canceled.
- Send burnout Alarm When burnout (see on page 3-28) occurs, an alarm signal is output to the alarm output terminal.
- Does not occur: Alarm signal is not output to the alarm output terminal when burnout occurs.
 - Occurs: Alarm signal is output to the alarm output terminal when burnout occurs.
Alarm is output to the output terminal set in the Alarm level settings.

Trigger level settings/Alarm level settings

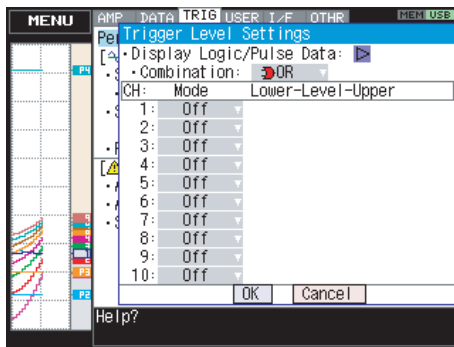

Mode Specifies mode trigger/alarm output conditions.

Off: Does not enable trigger/alarm.

H: A trigger/alarm is generated when the signal input rises to (or exceeds) the specified level.

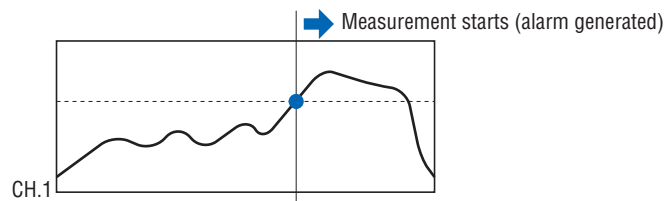

L: A trigger/alarm is generated when the signal input falls to (or falls below) the specified level.

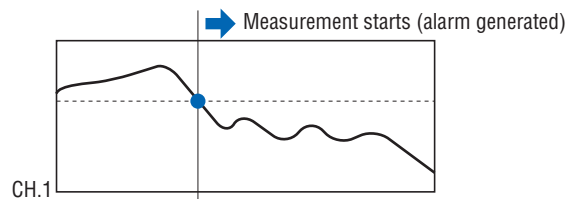

Win In: Used to specify the upper and lower limits for each channel. When the signal level goes within (or is within) either limit, a trigger/alarm is generated.

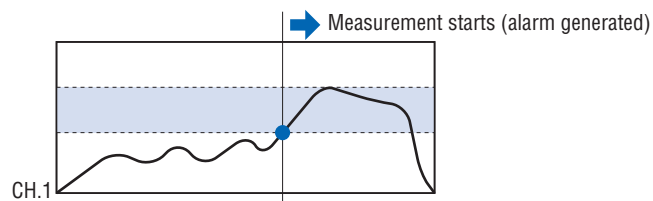

Win Out: Used to specify the upper and lower limits for each channel. When the signal level goes outside (or is outside) either limit, a trigger/alarm is generated.

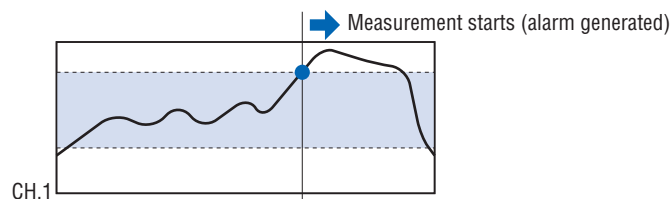

Lower - Level - Upper Specifies the trigger/alarm level(s) for the conditions set in Mode.

- H, L: Input a numeric value.

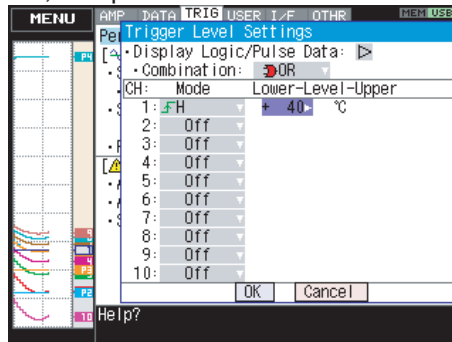

- Win In, Win Out: Input a numeric value for the upper and lower limit.

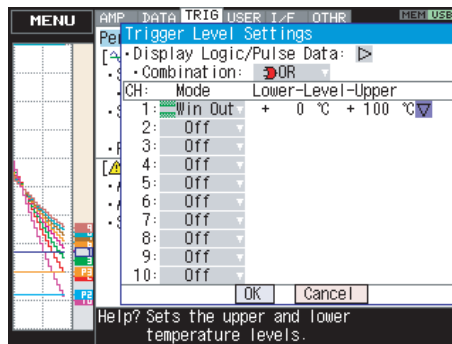

Combination (for trigger only)....Sets the combination of trigger conditions set for each channel.

OR: Starts (stops) capturing data when at least one trigger condition is met.

AND: Starts (stops) capturing data only when all trigger conditions are met.

Pulse

Specifies the trigger/alarm for pulse input signals.

These conditions can be set when they have been enabled in the AMP settings.

Mode Specifies the same conditions as for analog CH conditions (see on page 3-23).

Lower - Level - Upper Specifies the trigger/alarm level(s) for the conditions set in Mode.

- H, L: Input a numeric value

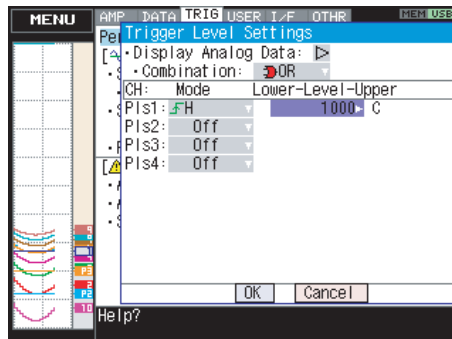

- Win In, Win Out: Input numeric values for the upper and lower levels.

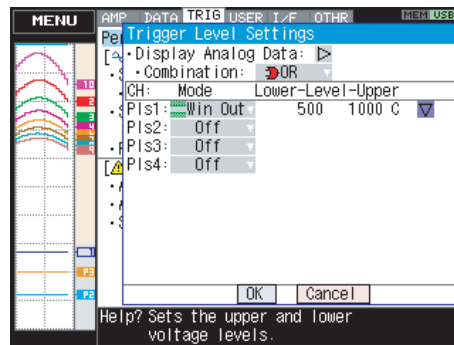

Logic

Sets the trigger/alarm conditions for logic input.

These conditions can be set when they have been enabled in the AMP settings.

- Off: No trigger/alarm conditions set.
- H: Enabled when the logic signal goes from High to Low.
- L: Enabled when the logic signal goes from Low to High

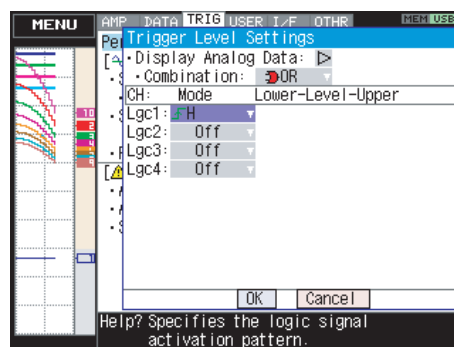

USER settings

This menu is used to store setting conditions for each user. By switching between users, these setting conditions can easily be read out.

This menu is used to specify the user name and switches user setting conditions.

You can specify that the user is a Guest, User 1 or User 2.

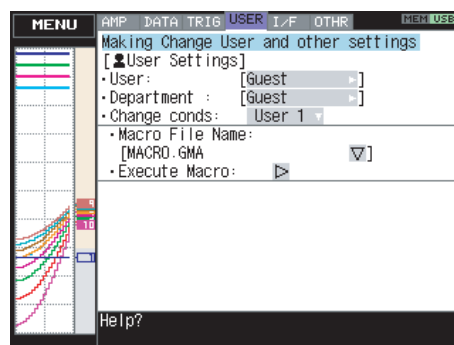

- User: Specify the user name. You cannot specify it as Guest.
- Department name: Specify the department name. You cannot specify it as Guest.

- Setting condition switch: Switches between Guest, User 1 and User 2. Since setting conditions are stored for each user, they can be called up easily by simply switching the user.
- Macro file name: Specify the macro file name to be executed.
- Macro run: Executes the specified macro file.

About the Macro

Interface commands for GL800 can be described in a text file and read in. GL800 will operate as described in this file.

<Macro operation flow>

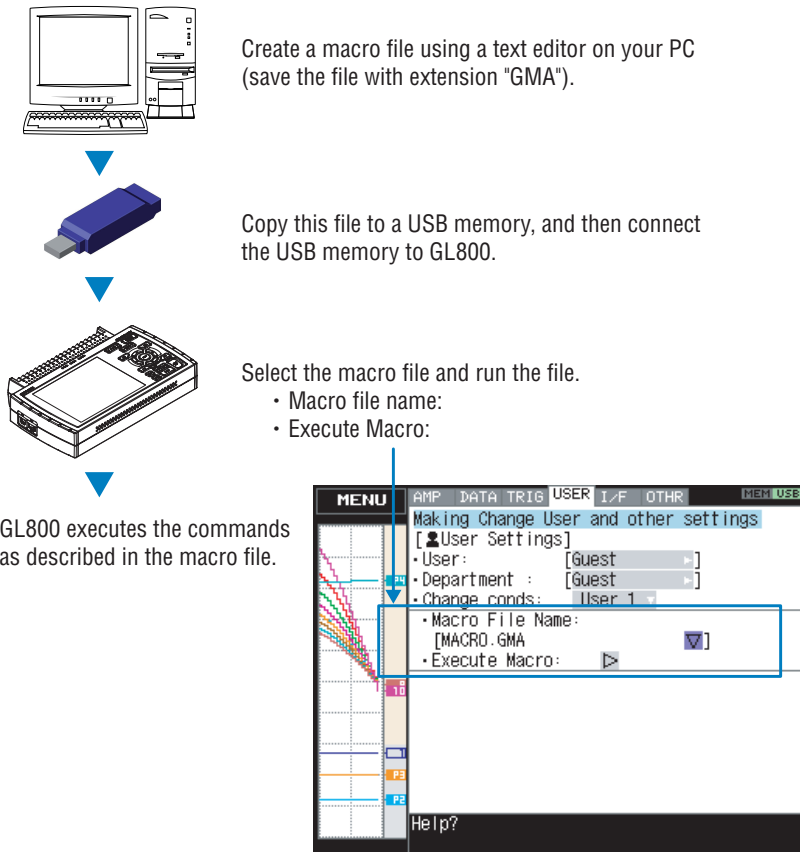

Macro description example (file name: xxx.GMA)

```

MACRO.GMA - Notepad
File Edit Format View Help
// ***** GL800 Macro File *****
// Input Setting
:AMP:CH1:INP TEMP:RANG TCT // CH1 Temperature
:AMP:CH2:INP DC:RANG 500mV // CH2 DC 500mV
:AMP:CH3:INP RH // CH3 Humidity
// Span Setting
:SPAN:CH1:SET 100,0,"C" // CH1 0-100C
// Annotation Setting
:ANN:CH1 "Batt. Temp" // CH1 Annotation
// Sampling Setting
:DATA:SAMP 1S // Sampling 1sec
    
```

CAUTION

Refer to the "Interface Command Table" for details on commands supported by GL800 on a separate sheet.
 The "Interface Command Table" is included in the CD.
 Supported commands are limited to those relative to GL800 settings.
 Read in commands cannot be used.

Interface settings

This menu is used to specify conditions for PC connection.

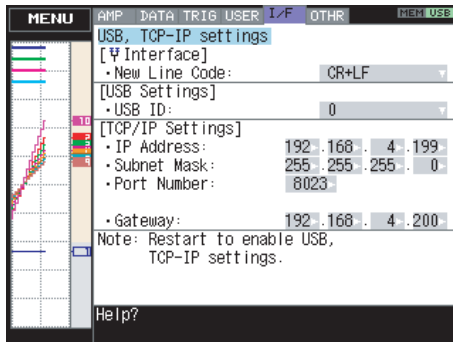

Settings	Selections available
New Line code	CR+LF, LF, CR
USB ID	0 to 9
IP address	Numerical value
Subnet mask	Numerical value
Port number	Numerical value
Gateway	Numerical value

- New Line code Specifies the line feed code.
 CR+LF :Starts a new line with CR+LF code (default value).
 LF :Starts a new line with LF code.
 CR :Starts a new line with CR code.
- USB Specify settings relative to USB interface.
- USB ID :Sets the USB ID number of GL800.
 Specify a number from 0 to 9 (default value: 0).
- TCP-IP Specify TCP-IP settings of GL800.
- IP address : Specifies the IP address.
 Default value (192.168.0.1)
 - Subnet mask : Sets the subnet mask.
 Default value (255.255.255.0)
 - Port number : Sets the port number.
 Specify a value from 1024 to 65535.
 Default value (8023)
 - Gateway : Sets the gateway address.
 Default value (0.0.0.0)

CAUTION

You must restart GL800 when any change is made to an interface setting value.
 If you continue to operate GL800 without restarting after these changes, the new setting values will not be applied. As a result, the GL800 will not be able to establish a connection to your PC.

OTHR settings

Other miscellaneous settings are made here.

```

MACRO.GMA - Notepad
File Edit Format View Help
// ***** GL800 Macro File *****
// Input Setting
:AMP:CH1:INP TEMP;RANG TCT // CH1 Temperature
:AMP:CH2:INP DC;RANG 500MV // CH2 DC 500mV
:AMP:CH3:INP RH // CH3 Humidity
// Span Setting
:SPAN:CH1:SET 100,0,"C" // CH1 0-100C
// Annotation Setting
:ANN:CH1 Batt. Temp // CH1 Annotation
// Sampling Setting
:DATA:SAMP 1S // Sampling 1sec
    
```

Setting	Selections available
LCD brightness	Light, Medium, Dark
Screen Saver	Off, 10, 30 (sec.), 1, 2, 5, 10, 30, 60 (min.)
Power On Start	Disable, Enable
Room Temp.	Internal, External
Temp. Unit	°C, °F
Burn Out	Off, On
AC Line Frequency	50/60Hz (Off, On)
Date/Time	Date, time settings
Language	Japanese, English (US), English (UK), French, German
Return to default settings	
Information	Firmware version System Control MAC Address
Demo Waveform Mode	Off, On
Game	Memory test game Number order game

- LCD brightness Sets the brightness of the LCD backlight.
Available selections are Light, Medium, and Dark.
Selecting Dark allows longer operational time with batteries.
- Screen Saver Automatically turns off the display if the GL800 is not operated within a specified interval.
Available selections are Off, 10, 30s, 1, 2, 5, 10, 30, 60 min.
Turning off the display frequently using the Screen Saver function allows longer operational time with batteries and longer lifetime of the LCD screen.
- Power On Start Sets the feature which initiates measurement as soon as the GL800 is turned on.
 - Disable: Disables the Power On Start function.
 - Enable: Enables the Power On Start function.
- Room Temp. Compensation This parameter enables room temperature compensation settings when thermocouples are used. You can select either internal or external room temperature compensation.
 - Internal: The GL800's room temperature compensation settings are used (usually, you use this parameter).
 - External: This parameter is set to enable room temperature compensation settings in external devices.
- Temp. Unit Toggles the temperature unit between °C and °F.
 - °C: Celsius
 - °F: Fahrenheit (the scaling function is compulsorily enabled)

- Burn Out Sets a feature which checks sensor burnout in a thermocouple.
- Off: Disables burnout check.
 - On: Enables periodic burnout check.

⚠ CAUTION

During a burnout check, voltage is applied to the GL800. Therefore, set Burn Out to "Off" when GL800 is connected in parallel with other devices to avoid any effect from these voltages.

- AC Line Frequency Select the frequency of the AC line used.
- 50Hz : For areas using line frequency of 50Hz
 - 60Hz : For areas using line frequency of 60Hz

⚠ CAUTION

This setting specifies the frequency in which noise can be eliminated with the digital filter function. Note that specifying an incorrect value will not achieve line noise elimination. The table below shows the sampling speed which enables the digital filter function.

Number of Measuring Channels*	Sampling Interval which enables Digital Filter
10 channels or less	500ms or above
11CH to 20CH	1s or above
21CH to 50CH	2s or above
51CH to 100CH	5s or above
101CH to 200CH	10s or above

* "Number of Measuring Channels" is the number of channels in which input settings are NOT set to "OFF".

- Date/Time This parameter sets the date and time.
- Language This parameter sets the GL800's display language.
- Return to default settings Returns all the settings to the factory defaults.
- Information Displays system information.
- Demo Waveform Mode This parameter displays demo waveforms without analog signal input. Triangular waveforms, rectangular waveforms and noise are displayed in order.
- You can capture and replay demo waveforms.
- Off: Do not display demo waveforms.
 - On: Display demo waveforms.
- Game Three games are available. The score is stored for each user.

Other menus

FILE

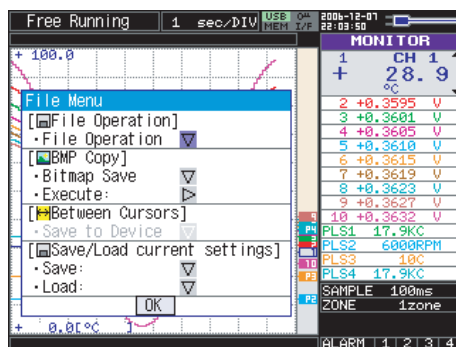

This menu is used to perform file-related operations.

- File Operation Operate files in the main memory and USB device.
For details on file operation, see on page 3-31.
- BMP Save Saves a copy of the screen as a BMP file.

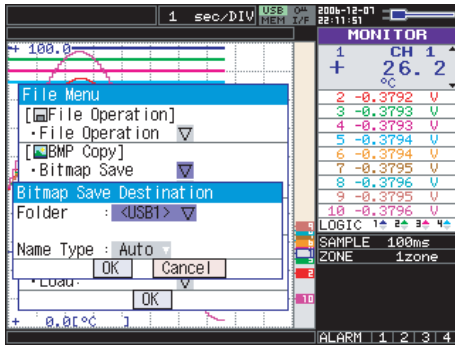

Folder/File: Specify a folder when the Name Type is set to Auto.
Specify a file name when the Name Type is set to User.

Name Type: Specifies how files are named.

- Auto: Automatically uses the capture start time as the file name.
- User: Sets to a user-defined name.

Execute: Executes bitmap save.

- Save Data Between Cursors When captured data is replayed, the data between cursors A and B is saved.

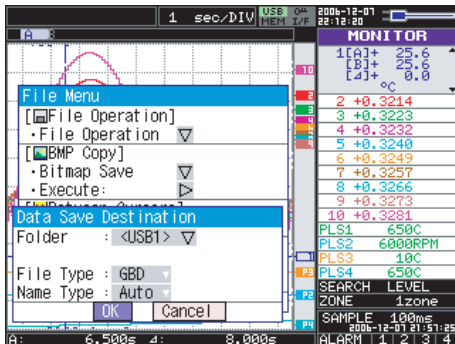

Folder/File: Specify a folder when Name Type is set to Auto.
Specify a file name when the Name Type is set to User.

File Format Specifies the file format used to save data.

- GBD: Binary format
- CSV: EXCEL format (such data cannot be replayed with the GL800)

Name Type: Specifies how to name a file.

- Auto: Automatically uses the capture start time as the file name.
- User: Sets to a user-defined name.

- Save current settings/Load settings Saves or loads main unit condition settings.

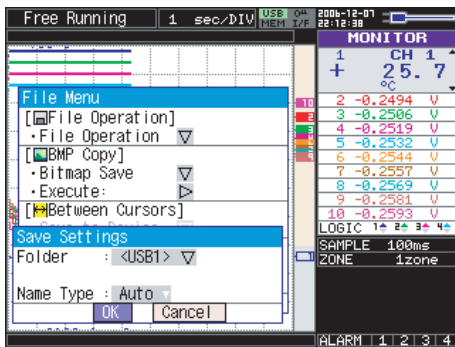

Folder/File: Specify a folder when Name Type is set to Auto.
Specify the file name when the Name Type is set to User.

Name Type: Specifies how to name a file.

- Auto: Automatically uses the capture start time as the file name.
- User: Sets to a user-defined name.

File format is fixed to CND.

File box

The file box used to set captured data files using the DATA menu or for disk operations accessed using the FILE menu is operated as follows.

<File box by disk operations>



<File box using the DATA menu>

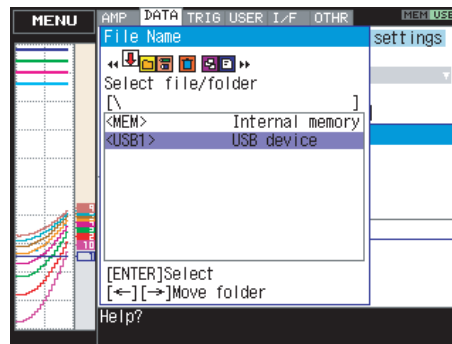

Key	Description
	Change the operation of the file box. Show properties Display details of a file or folder. Select file/folder Select files or folders to write data. Create new folder Create a new folder. Create new file Create a new file. Rename Change the file or folder name. Copy file/folder Copy files or folders. Select file to copy/delete Select the file to copy or delete. Select copy destination and copy . Select the copy destination and copy. Delete file/folder Delete files or folders. Change file sort order Change the order in which files are displayed. View setting Change displaying information for files. Format disk Format the disk. <i>* Details of allowed operation will depend on the operation target.</i>
	Moves between folders. ◀ : Move up one folder. ▶ : Move down one folder.
ENTER	Finalize the operation.
QUIT	Close the file box.

<Setting example>

The following shows an operation example where a folder named "TEST" is created for captured data and automatically saved.

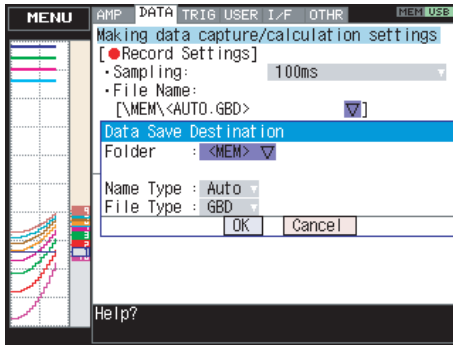

In the [Data save Destination], choose [Select folder] and press the ENTER key.

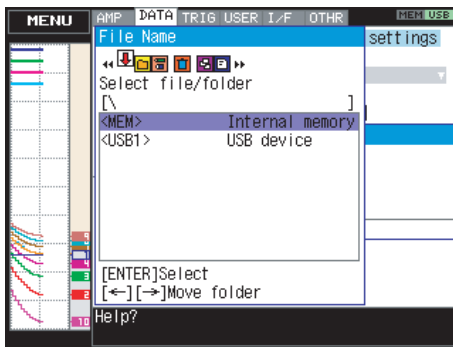

Use the > key to move to the target folder.

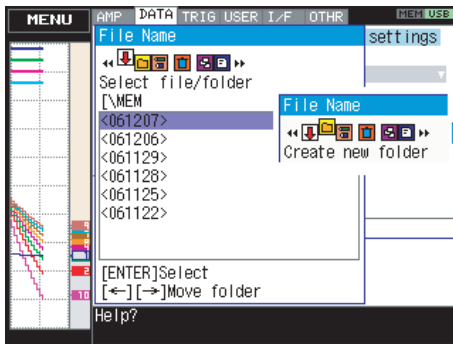

Use the >> key to select [Create new folder].

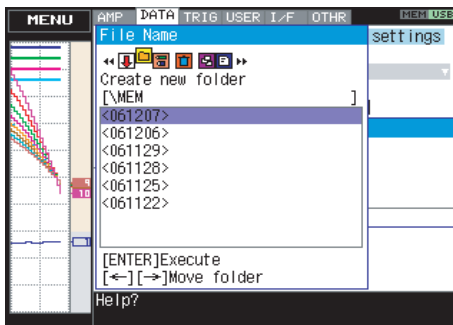

Press the ENTER key. In the [New folder name] box that appears, type in "TEST".

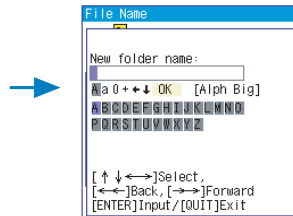

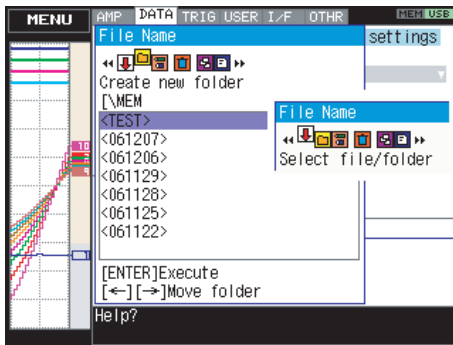

Use the ◀▶ key to choose [Select file/folder].

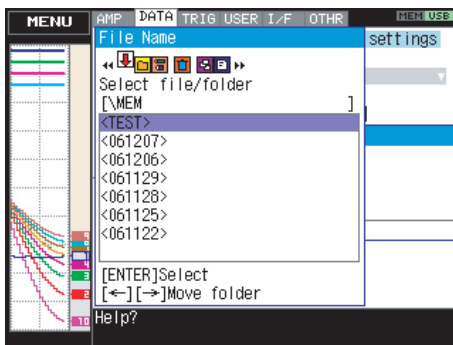

Use the ▾ key to move the cursor to the created "TEST" folder, and press the ENTER key.

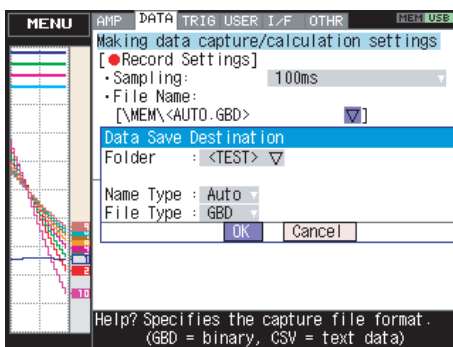

Select [OK] to close the screen.

Text input

Related to text input operations such as annotation, EU (scaling) unit and captured data file name input.

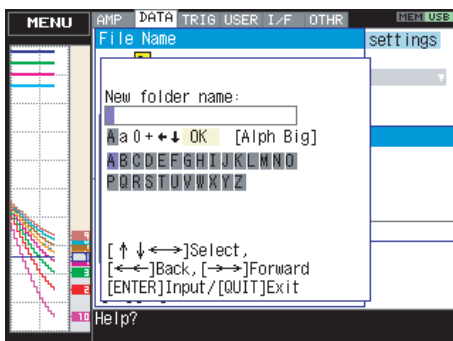

• Operation

Operation mode	Description	Operation method
Text input	A	Upper case alphabet mode
	a	Lower case alphabet mode
	0	Numeric mode
	+	Symbol mode
	←	Delete mode
	↓	Insert mode
	OK	Finalize mode
When selecting operation	Text used for each operation	When you bring the cursor to a character and press ENTER, the character is entered. After you finish entering characters, move the cursor to OK and then press ENTER.

Data replay menu

Data replay menus are displayed by pressing the MENU key during replay.

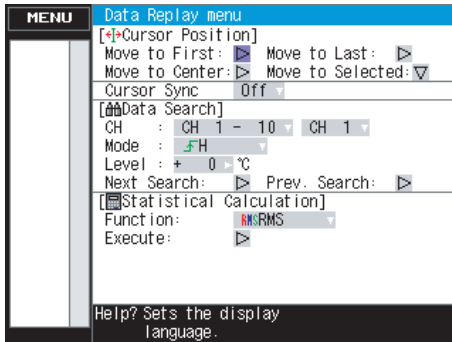

Setting	Selections available
Cursor Position	• Move to First Data
	• Move to Last Data
	• Move to Center
	• Move to Selected Position
	Method : Position, Time Move to : Relative time (position only) : Absolute time (time only)
Cursor Sync	Off, On
Data Search	• CH : CH1 to 200, Pulse, Logic, Alarm
	• Mode Analog : H, L Pulse : H, L Logic : H, L Alarm : Both, H, L
	• Level : Level: set numeric value (selectable only when analog or pulse)
	• Next Search
	• Prev. Search
Statistical Calculation between cursors	• Statistical Calculation : Off, Average, Max, Min, Peak, RMS
	• Execute

Cursor Position There are other functions for Cursor Move apart from the Level search function.

Move to First Data: Moves the cursor to the start of the data.

Move to Last Data: Moves the cursor to the end of the data.

Move to Center: Moves the cursor to the center of the data.

Move to Selected Position: Specify the cursor position to be moved to.

- Position: Move at the specified time from the start of measurement. Interval until the end of measurement, in 0.1s units

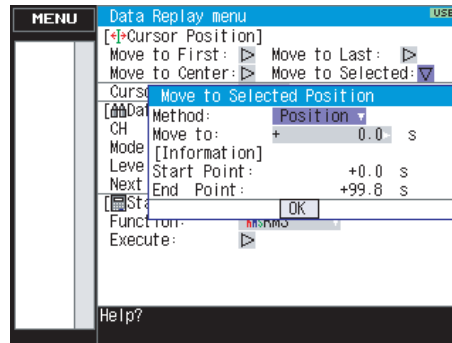

- Time: Move to the specified date/time.

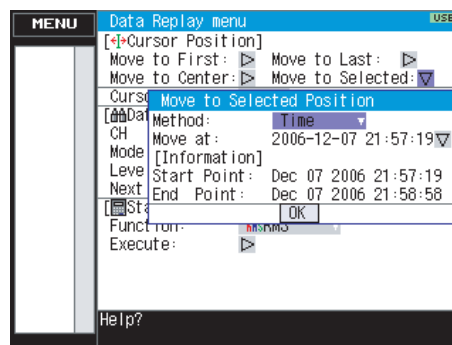

Cursor Sync Moves cursors A and B simultaneously. Cursor A is always the fulcrum.

Date Search This function searches within the captured data using the specified method.

CH: Select the channel you want to search.

Mode: Select the mode used for search. The setting is changed depending on the searched channel.

(For analog CH, pulse, and logic)

- H: Operates when the searched data rises to a specified level.
- L: Operates when the searched data falls to a specified level.

(For alarm)

- Both: Operates when a searched alarm is generated or canceled.
- H: Operates when a searched alarm is generated.
- L: Operates when a searched alarm is canceled.

Level: Sets the level to be searched for analog CH and pulse.

Statistical calculation between cursors:

Statistical calculation is performed on the data between the cursors.

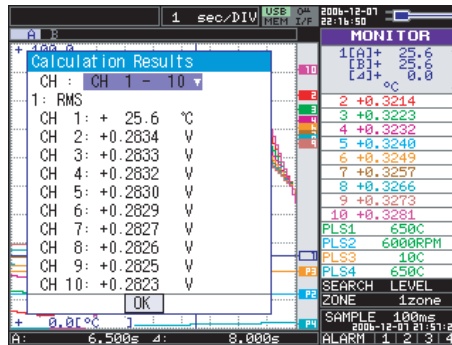

Function: There are five types of between-cursor calculation functions and one of these can be selected. (For details of each function, see on page 3-20.)

Calculation results are displayed for 10 channels each and may be switched to display another group of 10 channels.

NAVI menu

The NAVI menu can be displayed in three modes, Free Running, Recording, and Replay.

Operation	Description
Open	Press the NAVI key to open the NAVI menu.
Close	Press the NAVI key to close the NAVI menu.
Browse explanation	Explanation is displayed when an enabled key is pressed.

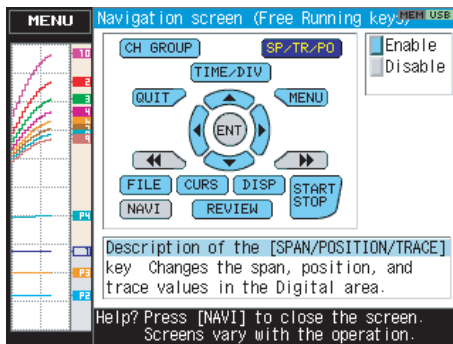

Quick settings

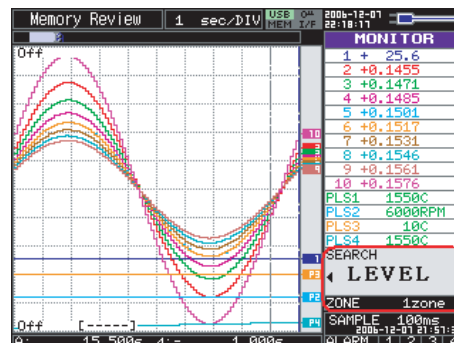

You can easily set two items on the digital area of the Waveform + Digital screen.

To set items, use the up/down key to go to the Quick setting area.

Content differs depending on the operation mode.

Operation mode	Content	Explanation
Free Running	SAMPLE	Left/right key can be used to change the sampling interval.
	ZONE	Left/right key can be used to change the zone division.
Recording	ZONE	Left/right key can be used to change the zone division.
Replaying	SEARCH	Left/right key can be used to perform search. Left: Searches past side Right: Searches future side
	ZONE	Left/right key can be used to change the zone division.

To cancel key lock by password

A password can be set to GL800 to cancel the key lock.

(No password is set at factory default.)

<Operation flow>

1. Set the password.

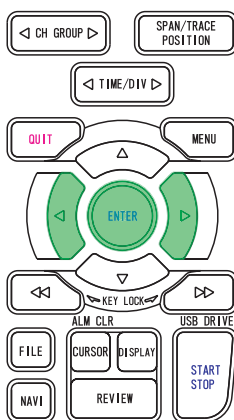

Press the <, >, and ENTER keys at the same time to display the password setting screen shown below. Specify a 4 digit password.



Use the <, >, Δ, ∇ keys to select numbers. Press the ENTER key to confirm the password.

Specifying 0000 will disable password operation.

In case you forgot your password, please contact us to acquire the master password.

2. Set the key lock.

Hold down the << and >> keys together for at least two seconds.

3. Cancel the key lock.

Hold down the << and >> keys together again for at least two seconds.

The password setting screen shown below will be displayed. Set a password.

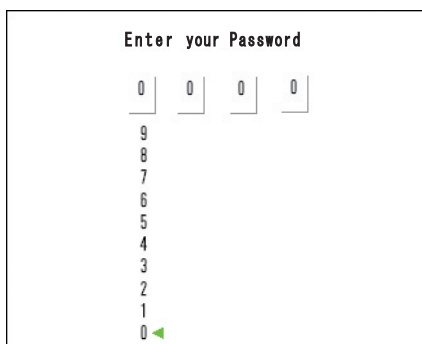

Entering an incorrect password will not cancel key lock.

Key lock state will be retained when power is turned off.

3.5 WEB Server Function

This function allows operating and monitoring GL800 via a Web browser.

- **Supported Web browsers**

- Microsoft Internet Explorer 6.0 or later
- Netscape 6.2 or later
- Firefox 1.5 or later
- Opera 9.0 or later

- **Available functions using a Web browser**

- Operating GL800
- Monitoring GL800 display screen
- Enlarging GL800 display screen
- Linking to FTP
- Linking to our Web site

- **Setting the URL**

The URL (Uniform Resource Locator) must be correctly set according to your network environment. Follow the procedure below to access the GL800.

<http://IP address/Index.html>

- http Protocol to access the server.
HTTP (Hyper Text Transfer Protocol)
- IP address Type in the IP address of the GL800 to monitor.
- Index.html File name. This is fixed to Index.html.

- **Procedure**

1. Open the Web browser.
2. Type in the URL (<http://IP address/Index.html>) in the address input field.



3. The following pages are displayed.

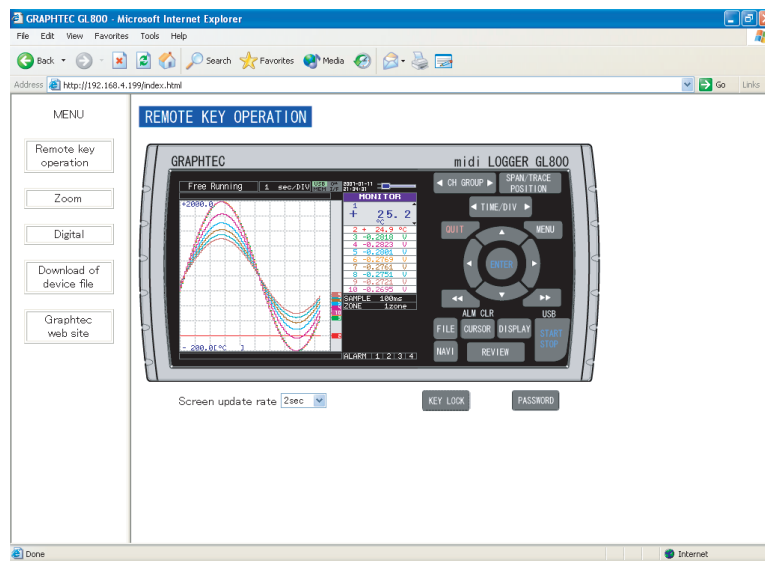

Remote key operation..... Allows GL800 operation.

Zoom..... Enlarges only the LCD screen of GL800.

Digital..... Displays the GL800 measured value digitally.

Download of device file..... Allows data captured with GL800 to be downloaded to your PC via FTP.

Graphtec Web site..... Accesses to our Web site.

• Remote key operation

To operate GL800 from a remote location, click the corresponding GL800's panel keys on the screen.

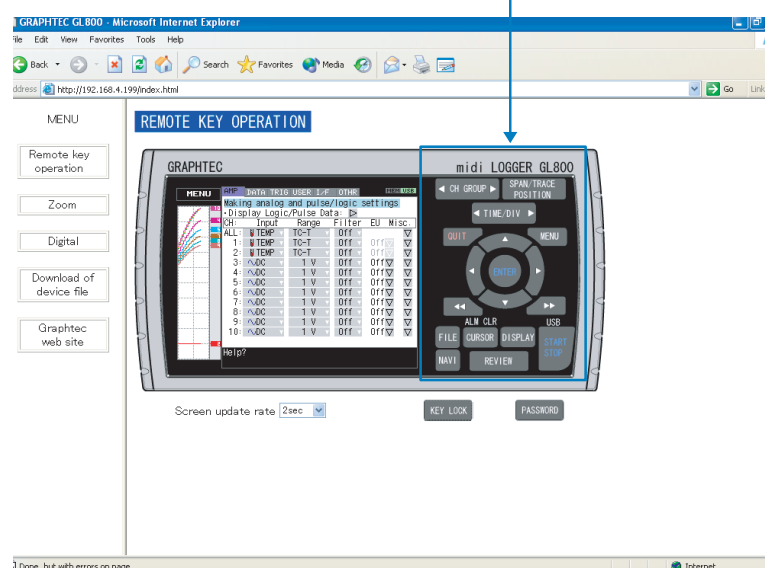

• Zoom

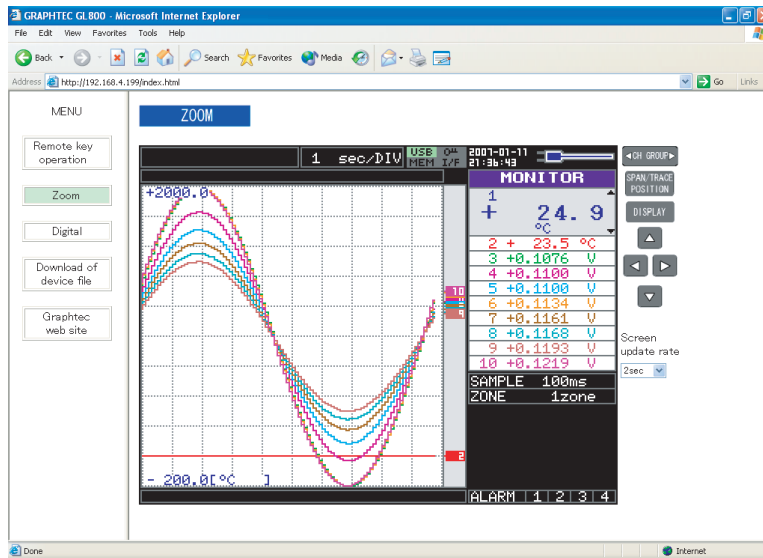

- CH GROUP Digital values for 10 channels are displayed on a single screen. Press this key to display the next group consisting of 10 channels.
- DISPLAY Switches the display mode. Press this key to switch among Waveform + Digital, Expanded Waveform, and Digital screens.
- SPAN/TRACE/POSTION Switches the display in the digital display area. Press this key to switch among MONITOR, SPAN, POSITION, and TRACE.
- ← → ↑ ↓ Cursor keys
- Screen update speed Specifies the speed in which the screen is updated. Available update speeds are 2, 5, and 10 seconds.

• Digital

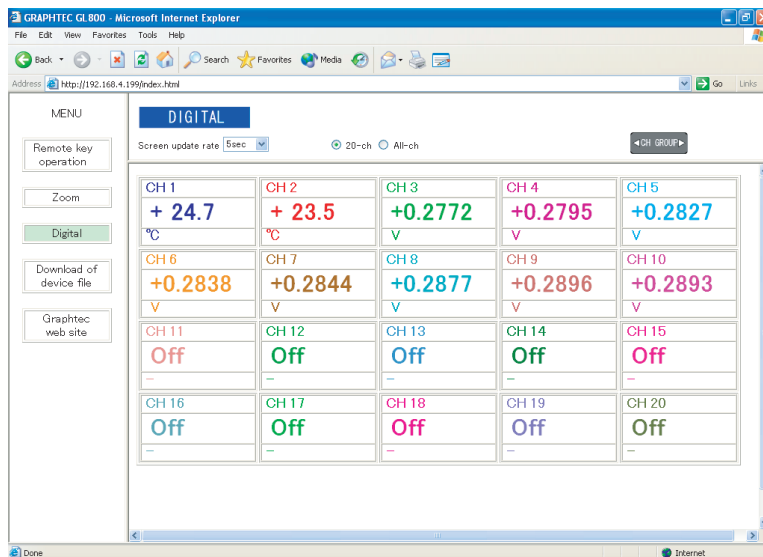

- Displayed CH Select either 20 channel display or ALL channel display.
- Switch CH group Displays digital values for 20 channels on a single screen. Press this key to display the next group consisting of 20 channels.
- Screen update speed Specifies the speed in which the screen is updated. Available update speeds are 2, 5, and 10 seconds.

• Download of device file

Allows memory data from GL800 and data in USB memory to be downloaded to your PC.

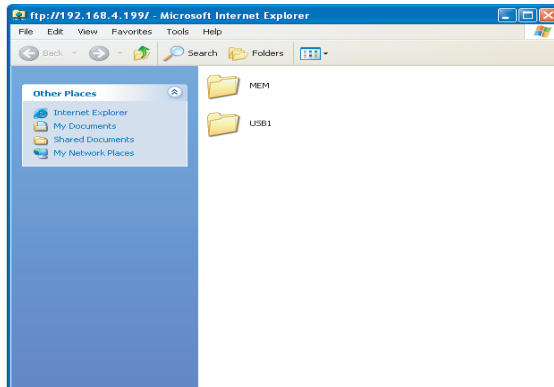

<About the FTP server function>

When an Internet Explorer FTP connection is used, login is automatically performed using an anonymous account and the files become read-only files.

The following operations cannot be performed for read-only files:

- Upload file
- Delete file/folder
- Create file/folder
- Change file name/folder name

To enable data to be written to the GL800, the login account name must be changed. please use the following table as a guide.

Account name	Password	Restrictions
GL800	None	None
gl800	None	None
Anonymous	Any	Read-only

The following procedure is used to change the Internet Explorer login account.

Go to the [File] menu and select [Login As...] to open the [login As] dialog box.

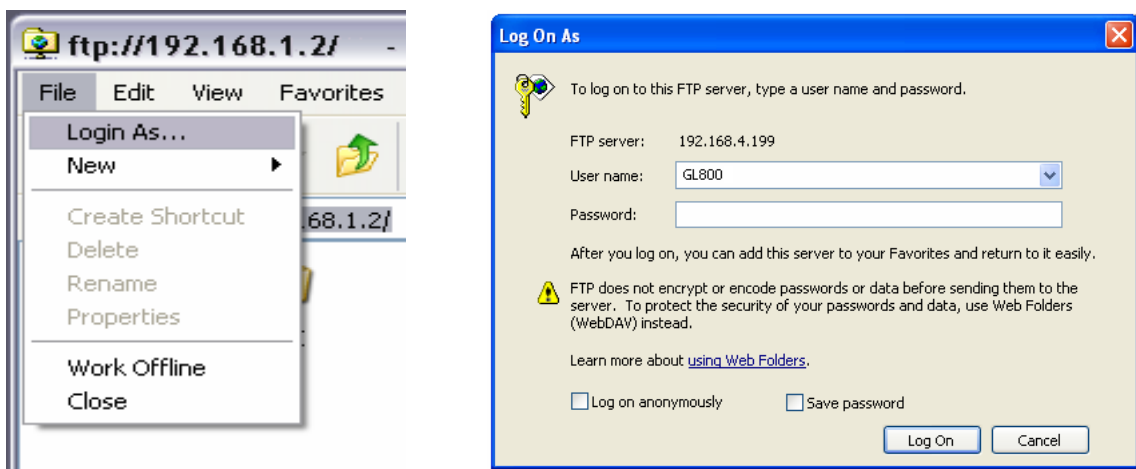

Enter the account name in the User Name box. leave the Password box blank.

Finally, click the “Login” button.

CHAPTER 4

Specifications

This chapter describes the basic specifications for the GL800.

- 4.1 Standard Specifications**
- 4.2 Function Specifications**
- 4.3 Accessory/Option Specifications**
- 4.4 External Dimensions**

4.1 Standard Specifications

Standard Specifications

Item	Description				
Number of analog input	1 unit (20 channels) or extension unit (maximum 200 channels)				
External input/output	Trigger input, Logic input 4 channels or Pulse input 4 channels, Alarm output				
PC interface	Ethernet (10BASE-T/100BASE-TX), USB (HighSpeed supported) provided as standard features				
Internal memory devices	Internal memory: approx. 12 MB USB memory slot (FullSpeed supported) is provided as a standard feature				
Data backup functions	Setup conditions: EEPROM; Clock: lithium secondary battery				
Operating environment	0 to 45°C, 5 to 85% RH (15 to 40°C when using batteries)				
Withstand voltage	Between each input channel and GND terminal : 1 minute at 350 Vp-p Between each input terminal : 1 minute at 350 Vp-p				
Power supply	AC adapter: 100 to 240 VAC, 50/60 Hz DC input: 8.5 to 24 VDC Battery pack (option): 7.2 VDC (2200 mAh), 2 packs mountable				
Power consumption	AC power consumption (when the supplied AC adapter is used)				
	No.	Condition	Normal consumption	Consumption during battery recharge	
	1	When the LCD is ON	16 VA	28 VA	
	2	When the screensaver is operating	11 VA	22 VA	
	DC power consumption				
	No.	DC voltage	Condition	Normal consumption	Consumption during battery recharge
	1	+24 V	When the LCD is ON	0.3 VA	0.7 VA
	2	+24 V	When the screensaver is operating	0.2 VA	0.6 VA
	3	+12 V	When the LCD is ON	0.55 VA	Recharging not possible
	4	+12 V	When the screensaver is operating	0.3 VA	Recharging not possible
5	+8.5 V	When the LCD is ON	0.8 VA	Recharging not possible	
6	+8.5 V	When the screensaver is operating	0.45 VA	Recharging not possible	
* Normal status is when LCD brightness is set to MAX.					
External dimensions	232 x 152 x 50 mm				
Weight*1	990 g				
Vibration-tested conditions	Equivalent to automobile parts Type 1 Category A classification				

*1 Excluding the AC adapter and battery. Including one terminal unit.

Internal memory devices

Item	Description
Memory capacity	Internal memory : approx. 12 MB Flash Memory USB memory : Max 2 GB (depends on the type of USB memory used)
Memory contents	<ul style="list-style-type: none"> • Setup conditions • Measured data • Screen copy

PC Interface

Item	Description
Interface types	Ethernet (10BASE-T/100BASE-TX) USB (HighSpeed)
Software functions	Data transfer to the PC (realtime, memory) PC control of the GL800
Ethernet functions (10BASE-T/100BASE-TX)	Web server function : Displays GL800's screen image on Web browser, operation of GL800
	FTP server function : Transfers and deletes files from internal memory and USB memory
USB functions	USB drive mode : Transfers and deletes files from internal memory
Realtime data transfer speed ^{*1}	100 msec/10 ch maximum

^{*1}: Depends on the number of transferring channels.

Monitor

Item	Description
Display	5.7-inch TFT color LCD (QVGA: 320 x 240 dots)
Displayed languages	Japanese, English, Others
Backlight life	50,000 hrs (when brightness is down to 50%), depends on operation environment
Backlight	Screen saver function provided (10, 30 s, 1, 2, 5, 10, 30, 60 min.)

Input Unit Specifications

Item	Description																																																																	
Number of input channels	20 channels (maximum 200 channels with extension unit)																																																																	
Input terminal type	M3 screw type terminals																																																																	
Input method	Photo MOS relay scanning system All channels isolated, balanced input																																																																	
Scan speed	0.1s/10 ch maximum																																																																	
Measurement ranges	Voltage: 20, 50, 100, 200, 500 mV; 1, 2, 5, 10, 20, 50 V; 1-5 V F.S. Temperature <ul style="list-style-type: none"> • Thermocouples: K, J, E, T, R, S, B, N, W (WRe5-26) • Resistance temperature detector: Pt100, JPt100, Pt1000 (IEC751) Humidity: 0 to 100% (voltage 0 V to 1 V scaling conversion) *with B-530 (option)																																																																	
Measurement accuracy ^{*1} (23°C ±3°C) <ul style="list-style-type: none"> • When 30 minutes or more have elapsed after power was switched on • Sampling 1 s/20 ch • Filter ON (10) • GND connected 	Voltage: 0.1% of F.S. Temperature <ul style="list-style-type: none"> • Thermocouple <table border="1"> <thead> <tr> <th>Thermo couple</th> <th>Measurement Temperature Range (°C)</th> <th>Measurement Accuracy</th> </tr> </thead> <tbody> <tr> <td rowspan="4">R/S</td> <td>0 ≤ Ts ≤ 100</td> <td>±5.2°C</td> </tr> <tr> <td>100 < Ts ≤ 300</td> <td>±3.0°C</td> </tr> <tr> <td>R: 300 < Ts ≤ 1600°C</td> <td>±(0.05% of rdg +2.0°C)</td> </tr> <tr> <td>S: 300 < Ts ≤ 1760°C</td> <td>±(0.05% of rdg +2.0°C)</td> </tr> <tr> <td rowspan="2">B</td> <td>400 ≤ Ts ≤ 600</td> <td>±3.5°C</td> </tr> <tr> <td>600 < Ts ≤ 1820°C</td> <td>±(0.05% of rdg +2.0°C)</td> </tr> <tr> <td>K</td> <td>-200 ≤ Ts ≤ -100</td> <td>±(0.05% of rdg +2.0°C)</td> </tr> <tr> <td></td> <td>-100 < Ts ≤ 1370°C</td> <td>±(0.05% of rdg +1.0°C)</td> </tr> <tr> <td rowspan="2">E</td> <td>-200 ≤ Ts ≤ -100</td> <td>±(0.05% of rdg +2.0°C)</td> </tr> <tr> <td>-100 < Ts ≤ 800°C</td> <td>±(0.05% of rdg +1.0°C)</td> </tr> <tr> <td rowspan="2">T</td> <td>-200 ≤ Ts ≤ -100</td> <td>±(0.1% of rdg +1.5°C)</td> </tr> <tr> <td>-100 < Ts ≤ 400°C</td> <td>±(0.1% of rdg +0.5°C)</td> </tr> <tr> <td rowspan="3">J</td> <td>-200 ≤ Ts ≤ -100</td> <td>±2.7°C</td> </tr> <tr> <td>-100 < Ts ≤ 100</td> <td>±1.7°C</td> </tr> <tr> <td>100 < Ts ≤ 1100°C</td> <td>±(0.05% of rdg +1.0°C)</td> </tr> <tr> <td>N</td> <td>0 ≤ Ts ≤ 1300°C</td> <td>±(0.1% of rdg +1.0°C)</td> </tr> <tr> <td>W</td> <td>0 ≤ Ts ≤ 2315°C</td> <td>±(0.1% of rdg +1.5°C)</td> </tr> <tr> <td colspan="2">Reference contact compensation accuracy</td> <td>±0.5°C</td> </tr> </tbody> </table> <p><i>*1: Thermocouple diameters T: 0.32 φ, others: 0.65 φ</i></p> <ul style="list-style-type: none"> • Resistance temperature detector <table border="1"> <thead> <tr> <th>Type</th> <th>Measurement Temperature Range (°C)</th> <th>Applied current</th> <th>Measurement Accuracy</th> </tr> </thead> <tbody> <tr> <td>Pt100</td> <td>-200 to 850°C (FS=1050°C)</td> <td>1mA</td> <td>±1.0°C</td> </tr> <tr> <td>Jpt100</td> <td>-200 to 500°C (FS=700°C)</td> <td>1mA</td> <td>±0.8°C</td> </tr> <tr> <td>Pt1000</td> <td>-200 to 500°C (FS=700°C)</td> <td>0.2mA</td> <td>±0.8°C</td> </tr> </tbody> </table>	Thermo couple	Measurement Temperature Range (°C)	Measurement Accuracy	R/S	0 ≤ Ts ≤ 100	±5.2°C	100 < Ts ≤ 300	±3.0°C	R: 300 < Ts ≤ 1600°C	±(0.05% of rdg +2.0°C)	S: 300 < Ts ≤ 1760°C	±(0.05% of rdg +2.0°C)	B	400 ≤ Ts ≤ 600	±3.5°C	600 < Ts ≤ 1820°C	±(0.05% of rdg +2.0°C)	K	-200 ≤ Ts ≤ -100	±(0.05% of rdg +2.0°C)		-100 < Ts ≤ 1370°C	±(0.05% of rdg +1.0°C)	E	-200 ≤ Ts ≤ -100	±(0.05% of rdg +2.0°C)	-100 < Ts ≤ 800°C	±(0.05% of rdg +1.0°C)	T	-200 ≤ Ts ≤ -100	±(0.1% of rdg +1.5°C)	-100 < Ts ≤ 400°C	±(0.1% of rdg +0.5°C)	J	-200 ≤ Ts ≤ -100	±2.7°C	-100 < Ts ≤ 100	±1.7°C	100 < Ts ≤ 1100°C	±(0.05% of rdg +1.0°C)	N	0 ≤ Ts ≤ 1300°C	±(0.1% of rdg +1.0°C)	W	0 ≤ Ts ≤ 2315°C	±(0.1% of rdg +1.5°C)	Reference contact compensation accuracy		±0.5°C	Type	Measurement Temperature Range (°C)	Applied current	Measurement Accuracy	Pt100	-200 to 850°C (FS=1050°C)	1mA	±1.0°C	Jpt100	-200 to 500°C (FS=700°C)	1mA	±0.8°C	Pt1000	-200 to 500°C (FS=700°C)	0.2mA	±0.8°C
Thermo couple	Measurement Temperature Range (°C)	Measurement Accuracy																																																																
R/S	0 ≤ Ts ≤ 100	±5.2°C																																																																
	100 < Ts ≤ 300	±3.0°C																																																																
	R: 300 < Ts ≤ 1600°C	±(0.05% of rdg +2.0°C)																																																																
	S: 300 < Ts ≤ 1760°C	±(0.05% of rdg +2.0°C)																																																																
B	400 ≤ Ts ≤ 600	±3.5°C																																																																
	600 < Ts ≤ 1820°C	±(0.05% of rdg +2.0°C)																																																																
K	-200 ≤ Ts ≤ -100	±(0.05% of rdg +2.0°C)																																																																
	-100 < Ts ≤ 1370°C	±(0.05% of rdg +1.0°C)																																																																
E	-200 ≤ Ts ≤ -100	±(0.05% of rdg +2.0°C)																																																																
	-100 < Ts ≤ 800°C	±(0.05% of rdg +1.0°C)																																																																
T	-200 ≤ Ts ≤ -100	±(0.1% of rdg +1.5°C)																																																																
	-100 < Ts ≤ 400°C	±(0.1% of rdg +0.5°C)																																																																
J	-200 ≤ Ts ≤ -100	±2.7°C																																																																
	-100 < Ts ≤ 100	±1.7°C																																																																
	100 < Ts ≤ 1100°C	±(0.05% of rdg +1.0°C)																																																																
N	0 ≤ Ts ≤ 1300°C	±(0.1% of rdg +1.0°C)																																																																
W	0 ≤ Ts ≤ 2315°C	±(0.1% of rdg +1.5°C)																																																																
Reference contact compensation accuracy		±0.5°C																																																																
Type	Measurement Temperature Range (°C)	Applied current	Measurement Accuracy																																																															
Pt100	-200 to 850°C (FS=1050°C)	1mA	±1.0°C																																																															
Jpt100	-200 to 500°C (FS=700°C)	1mA	±0.8°C																																																															
Pt1000	-200 to 500°C (FS=700°C)	0.2mA	±0.8°C																																																															
Reference contact compensation accuracy	Internal/External switching																																																																	
A/D converter	16 bits (out of which 14 bits are internally acknowledged)																																																																	
Temperature coefficient	Gain: 0.01% of F.S./ °C																																																																	
Input resistance	1 MΩ ±5%																																																																	
Allowable signal source resistance	Within 300 Ω																																																																	
Maximum permissible input voltage	Between +/- terminals : 60 Vp-p Between input terminal/input terminal : 60 Vp-p Between input terminal/GND : 60 Vp-p																																																																	
Withstand voltage	Between input terminal/input terminal : 1 minute at 350 Vp-p Between input terminal/GND : 1 minute at 350 Vp-p																																																																	
Insulation resistance	Between input terminal/GND : At least 50MΩ (at 500 VDC)																																																																	
Common mode rejection ratio	At least 90 dB (50/60 Hz; signal source 300 Ω or less)																																																																	
Noise	At least 48 dB (with +/- terminals shorted)																																																																	
Filter	Off, 2, 5, 10, 20, 40 Filter operation is on a moving average basis. The average value of the set sampling count is used.																																																																	

4.2 Function Specifications

Function Specifications

Item	Description
Display screen	Waveform screen + Digital screen, Expanded Waveform screen, Digital screen + Calculation Display screen <i>Note: Can be key-toggled</i>
Sampling interval	100 ms/10 ch maximum 100, 200, 500 ms; 1, 2, 5, 10, 20, 30 s; 1, 2, 5, 10, 20, 30 min; 1 h
EU (scaling function)	4 points can be set for each channel
Review function	Data replay during data capture
Data save functions	Capture to internal memory Capture to USB memory The setup data can be saved (to internal or USB memory) Copy of data screen can be saved (to internal or USB memory)
Calculation	Types of statistical calculation : Average value, peak value, maximum value, minimum value, RMS Number of operations : maximum of 2 can be set simultaneously Method : Realtime and between cursors specified (during data replay) <i>Note: Calculation results are displayed in Digital screen + Calculation Display screen</i>
Search functions	Function: Search the captured data for the required number of points Search type: Channel Pulse, Logic, Level, Alarm search
Annotation input function	Function: A comment can be input for each channel Inputtable characters: Alphanumerics Number of characters: 11 (displayed up to 8 characters)

Trigger Functions

Item	Description
Repeat Trigger	Off, On
Trigger types	Start: Data capture starts when a trigger is generated. Stop: Data capture stops when a trigger is generated.
Trigger conditions	Start: Off, Level, External, Time, Alarm Stop: Off, Level, External, Time, Duration, Alarm
Alarm judgment modes	Analog : H (↑), L (↓), Window In, Window Out Logic : H (↑), L (↓) Pulse : H (↑), L (↓), Window In, Window Out
Channel combination	OR, AND

External Input/Output Functions

Item	Description
Input/output types	<ul style="list-style-type: none"> • Trigger input (1 ch) • Logic input (4 ch) or Pulse input (4 ch) • Alarm output (4 ch) <p><i>*Switch between Logic and Pulse</i></p>
Input specifications	<p>Maximum input voltage: 0 to +24 V (single-ended ground input) Input threshold voltage: Approx. +2.5V Hysteresis: Approx. 0.5 V (+2.5 to +3 V)</p>
Alarm output specifications	<p>Output format: Open collector output (5 V, 10 KΩ pull-up resistance) Contact capacity 5 V to 24 V, 100 mA or below Output conditions: Level judgment, window judgment, logic pattern judgment, pulse judgment</p>
Pulse input	<p>Revolutions mode (engines, etc.)</p> <ul style="list-style-type: none"> • Function: Counts the number of pulses per second; enables them to be converted to rpms. • Spans: 50, 500, 5000, 50 k, 500 k, 5 M, 50 M, 500 M PRM/F.S.
	<p>Counts mode (electric meters, etc.)</p> <ul style="list-style-type: none"> • Function: Displays a count of the number of pulses for each sampling interval from the start of measurement. • Spans: 50, 500, 5000, 50 k, 500 k, 5 M, 50 M, 500 M C/F.S.
	<p>Inst. mode</p> <ul style="list-style-type: none"> • Function: Counts the number of pulses for each sampling interval. Resets the count value after each sampling interval. • Spans: 50, 500, 5000, 50 k, 500 k, 5 M, 50 M, 500 M C/F.S.
	<p>Maximum number of pulse inputs</p> <ul style="list-style-type: none"> • Counts, Inst. modes: 50 k/sampling interval • Revolution counts mode: 50 k/s

4.3 Accessory/Option Specifications

Control Software

Item	Description
Compatible operating system	Windows 2000/XP
Functions	Main unit control, realtime data capture, data conversion
Main unit settings	Input settings, memory settings, alarm settings, trigger settings
Allowed connection	up to 10
Number of channels per connection	200 ch maximum
Maximum number of channels	500 ch maximum
Settings	AMP settings, data settings, trigger/alarm settings, report settings, others
Captured data	Realtime data (CSV, Binary) Memory data (CSV, Binary) USB memory data (CSV, Binary)
Display	Analog waveforms, logic waveforms, pulse waveforms, digital values
Display modes	Y-T View, X-Y View, Digital View, Meter View, Report View
File conversion	Between cursors, All data
Monitor functions	Alarm monitor enables sending of email to the specified address
Dual-screen function	Displays the current data alongside past data
Statistic/History	Displays maximum, minimum and average values during measurement
Report function	Enables creation of daily or monthly files

Accessories

Item Name	Description	Quantity
Quick Start Guide	GL800-UM-8xx	1
CD-ROM	GL800-CDM0xM (User Manual, Application software)	1
AC adapter	100 to 240 VAC, 50/60 Hz, Power supply cord for each area	1 set

Battery Pack B-517 (Option)

Item	Description
Capacity	7.2 V/2200 mAh
Battery type	Lithium secondary battery
Running time	Up to two packs can be mounted <When LCD is ON> Battery pack x 1 (brightness MAX) : approx. 2.5 hours Battery pack x 1 (brightness MIN) : approx. 3 hours Battery pack x 2 (brightness MAX) : approx. 5 hours Battery pack x 2 (brightness MIN) : approx. 6 hours <When LCD is OFF> Battery pack x 1 : approx. 4.5 hours Battery pack x 2 : approx. 9 hours <i>Note: When capturing to internal memory at 1 s, sampling, 20 channel terminals, using new battery packs at +25°C environment.</i> <i>Note: The running time depends on the operating environment.</i>
Charging method	Mount in the main unit
Time required for charging	Battery pack x 1 : approx. 4 hours Battery pack x 2 : approx. 8 hours
Switchover in the case of a power failure	Because the battery is used together with the AC adapter, the power supply will be switched automatically to the battery in the event of a power failure. <i>Note: The AC adapter is the primary power source.</i>
Operation environment	15 to 40°C
Other functions	<ul style="list-style-type: none"> When the battery is running low, file is closed automatically. (when captured to internal memory or USB memory) remaining amount indicator

Humidity Sensor B-530 (Option)

Item	Description
Allowable temperature range	-25 to +80°C
Allowable humidity range	0 to 100% RH
Relative humidity measurement accuracy	±3% RH (5 to 98% RH at 25°C)
Response time	15 s (90% response when membrane filter installed)
Sensor output	0 to 1 VDC
Sensor power source	5 to 16 VDC
Power consumption	approx. 4 mA
External dimensions	φ14 mm x 80 mm (excluding cable)
Cable length	3 m

Options

Item Name	Model	Description
Battery pack	B-517	7.2V/2200mAh
DC drive cable	B-514	2m, bare tips
Humidity sensor	B-530	3m, with dedicated power connector
Extension terminal base set	B-537	Extension terminal base unit, cable
20 channel extension terminal set	B-538	20 channel terminals, Extension terminal base unit, connection plate, screws
Logic alarm cable	B-513	2m, bare tips
T-type thermocouple	JBS-7115-5M-T	5m, set of 4
K-type thermocouple	JBS-7115-5M-K	5m, set of 4
K-type thermocouple (needle type probes)	RIC-410	1.1m
K-type thermocouple (stationary surface probes)	RIC-420	1.1m
K-type thermocouple (stationary surface L probes)	RIC-430	1.1m

4.4 External Dimensions

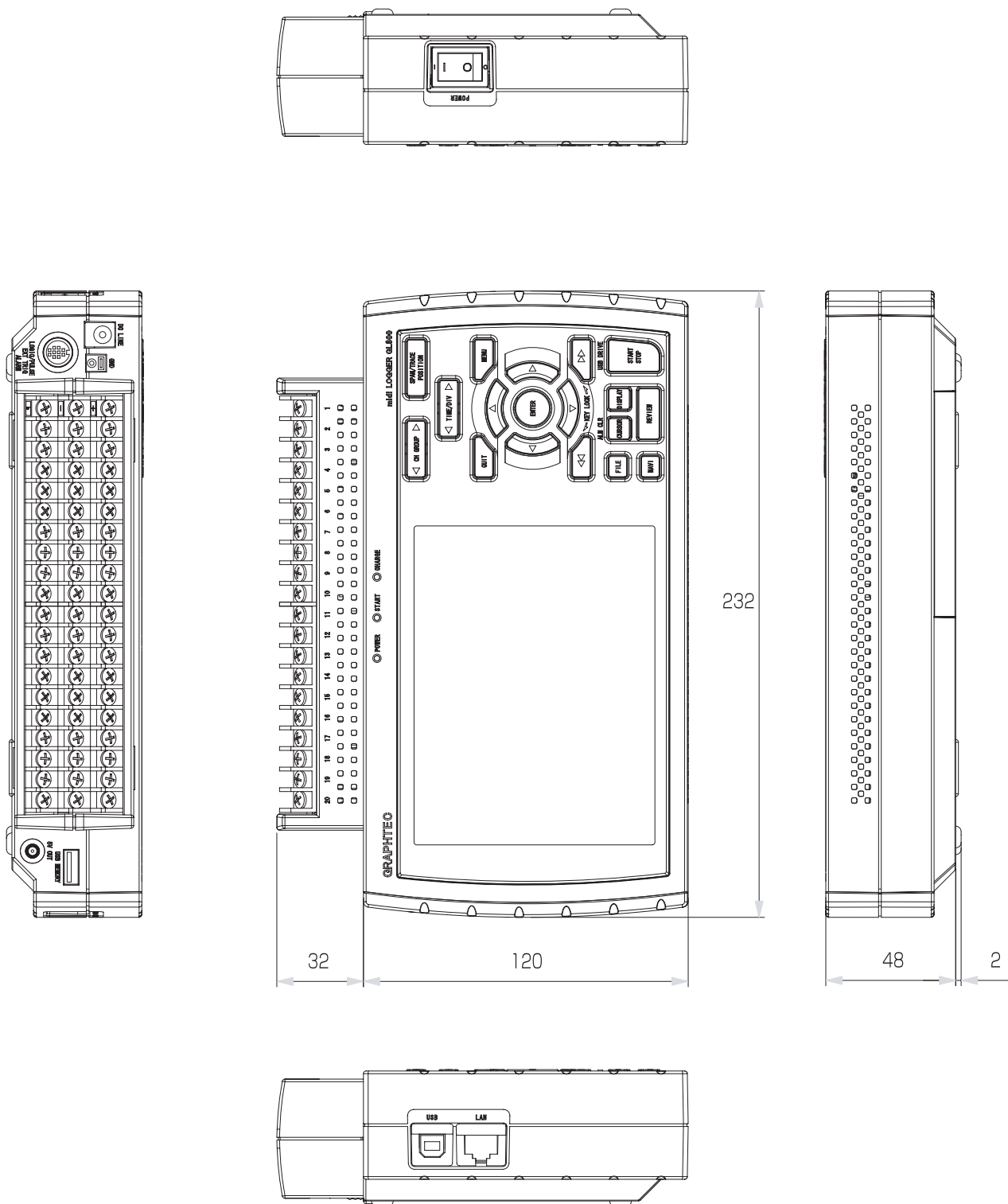

Dimensional precision: ±5 mm
Unit: mm

Index

A

AC	
Adapter	2-2
Cable	2-2
Power Supply, Connecting	2-4
AC Line Frequency	3-28
AC/battery status indicator	3-2
Accessories	2-2
Accessory Specifications	5-7
Alarm	
Functions	2-8
ALARM CLEAR	3-10
Alarm display area	3-2
Alarm Hold	3-21, 3-22
Alarm level settings	3-21, 3-22, 3-23
Alarm range	3-2
AMP settings	3-15
Analog Input Circuit Diagram	2-20
Annotation	3-18
Annotation setting	3-15
Auto Zero ADJ	3-18

B

Battery	
Charging	2-13
Pack	2-2
Battery Pack	
Mounting	2-12
Using	2-12
Burn Out	3-28, 3-29

C

Captured data file name	3-20
Capturing	3-13
CD-ROM	2-2
Configuration When in Use	1-3
Connecting	
PC	2-10
Power Cable	2-4
Control Software	5-7
CURSOR key	3-10

D

Data capture bar	3-3
Data replay menu	3-34, 3-36
DATA settings	3-20
Date and Time	2-22

Date/Time	3-28, 3-29
-----------------	------------

DC

Drive cable	2-2
Power Supply, Connecting	2-5
Demo Waveform Mode	3-28, 3-29
Department name	3-25
Digital display area	3-2
Direction key	3-6
Display	
Language	1-4
DISPLAY key	3-9
Dual View Replaying	3-13

E

ENTER key	3-7
EU (Scaling settings)	3-15
EU (Scaling)	3-17
External	
Dimensions	5-9
Input/Output Functions	5-6

F

FAST FORWARD key	3-7
Features	1-2
File box	3-31
File Format	3-21
FILE key	3-10
FILE menu	3-29
File name display area	3-3
Filter	3-15, 3-17
Free Running	3-12
Function	
Specifications	5-5

G

Game	3-28, 3-29
------------	------------

H

Humidity Sensor	2-14, 5-8
-----------------------	-----------

I

Information	3-28, 3-29
Input	3-15, 3-16
Unit Specifications	5-4
Internal memory devices	5-3

- K**
 KEY LOCK 3-7
 Key lock lamp 3-2
- L**
 Language 3-28, 3-29
 LCD brightness 3-28
 LOCAL 3-6
 Lower limit scale 3-3
- M**
 MENU key 3-6
 Misc. 3-15, 3-18
 Monitor 5-3
- N**
 Name Type 3-21
 NAVI key 3-11
 Noise Countermeasures 2-21
 Note
 Temperature Measurement 1-4
 Using the Monitor 1-4
- O**
 Operating Environment 1-3
 Option Specifications 5-7
 Optional Accessories 2-2
 Outer
 Casing, Checking 2-2
 Overview 1-2
- P**
 Part Names and Functions 2-3
 PC
 Interface 5-3
 Pen display 3-2
 Performing Measurement, Precautions to Observe
 2-20
 Power On Start 3-28
 Pulse 3-19
- Q**
 Quick settings 3-2
 Quick Start Guide 2-2
 QUIT key 3-6
- R**
 Range 3-15, 3-16
 Rechargeable Battery 2-22
 Remote lamp 3-2
 Repeated capturing 3-22
 Replaying 3-14
 Return to default settings 3-28, 3-29
 REVIEW key 3-8
 Room Temp. Compensation 3-28
- S**
 Sampling Interval 3-20
 Screen Saver 3-28
 Send burnout Alarm 3-22
 Send burnout alarm 3-21
 Setting condition switch 3-26
 Signal
 Input Cables 2-6
 Types 2-6
 Simplified message display area 3-2
 Slope 3-19
 SPAN
 Settings 3-5
 Span 3-18
 Span setting 3-15
 Standard
 Accessories 2-2
 Specifications 5-2
 Start side source settings 3-22
 START/STOP key 3-7
 Statistical calculation 3-21
 Stop side source settings 3-22
- T**
 Temp. Unit 3-28
 Text input 3-33
 Time/DIV display area 3-2
 TIME/DIV key 3-5
 TRIG settings 3-21
 Trigger
 Functions 5-5
 Trigger level 3-2
 Trigger level settings 3-23
 Turning on the Power 2-4
- U**
 Upper limit scale 3-3
 USB
 Cable 2-10
 USB Drive Mode 3-7
 User 3-25
- W**
 Warming-up Before Use 1-3

Waveform control display area3-2
Waveform display area3-3

The specifications, etc., in this manual are subject to change without notice.

GL800-UM-152

Apr 1, 2007 2nd edition-01

GRAPHTEC CORPORATION

GRAPHTEC CORPORATION

503-10 Shinano-cho, Totsuka-ku,
Yokohama 244-8503, Japan

Tel : +81(045)825-6250

Fax: +81(045)825-6396

Email: info@graphteccorp.com

Web : www.graphteccorp.com

Printed in Japan