

# GL220

**midi LOGGER**

## **USER'S MANUAL**

---

MANUAL NO. GL220-UM-151

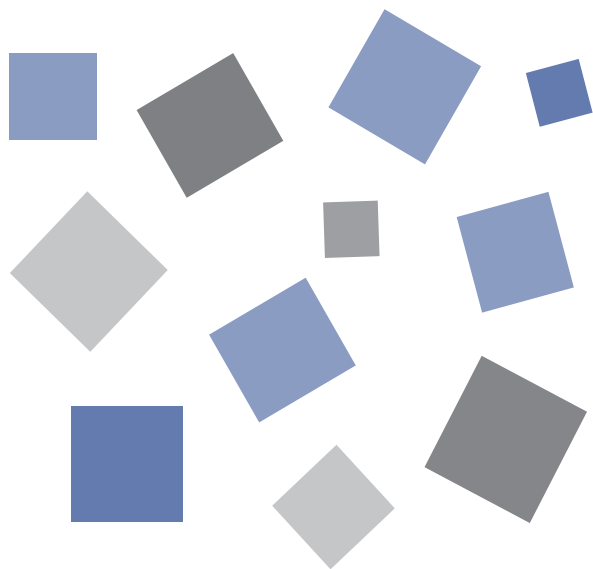

# **GRAPHTEC**

# Introduction

Thank you for purchasing the GL220 midi LOGGER.

Please read this manual thoroughly before attempting to use your new product to ensure that you use it correctly and to its full potential.

## Notes on Use

Be sure to read all of the following notes before attempting to use the GL220 midi LOGGER.

### 1. Note on the CE Marking

The GL220A complies with the EN61326 (Class A) standard based on the EMC directive (89/336/EEC).

It also conforms to the EN61010-1 standard based on the LV directive (72/23/EEC)

Although the GL220 complies with the above-mentioned standards, be sure to use it correctly in accordance with the instructions and notes provided in its User's Manual.

Moreover, use of the GL220 by incorrect procedures may result in damage to the GL220 or may invalidate its safeguards. Please confirm all of its notes regarding use and other related information to ensure correct use.

### 2. Warning

This is a Class A product according to the EMC directive. In a domestic environment, this product may cause radio interference or may be affected by radio interference to the extent that proper measurement cannot be performed.

### 3. Notes for Safe Operation

(1) Be sure to use the Graphtec-supplied AC adapter. In environments where there is a lot of noise or where the power supply is unstable, we recommend that you ground the GL220.

(2) When a high-voltage signal cable has been connected to the main unit's analog signal input terminal, avoid touching the leads of the input terminal's signal cable to prevent electrical shock due to high voltage.

(3) Ensure that the GL220's power source is positioned so that it can easily be disconnected.

### 4. Notes on Functions and Performance

(1) Be sure to connect the main unit to an AC or DC power supply that conforms to the rated range. Connection to a non-rated power supply may cause the main unit to overheat and break down.

(2) Do not block the vent on the main unit.

Continued operation with the vent blocked may cause the main unit to overheat and break down.

(3) To avoid malfunctions and other damage, avoid using the GL220 in the following locations.

- Places exposed to high temperature and/or high humidity, such as in direct sunlight or near heating equipment. (Allowable temperature range: 0 to 45°C (0 to 40°C when a battery pack is mounted), Allowable humidity range: 5 to 85%R.H.)
- Locations subject to excessive salt spray or heavy fumes from corrosive gas or solvents.
- Excessively dusty locations.
- Locations subject to strong vibrations or shock.
- Locations subject to surge voltages and/or electromagnetic interference.

(4) If the main unit becomes soiled, wipe it off using a soft, dry cloth. Use of organic solvents (such as thinner or benzene) causes deterioration and discoloration of the outer casing.

(5) Do not use the GL220 in the vicinity of other devices which are susceptible to electromagnetic interference.

(6) Measured results may not conform to the stated specifications if the GL220 is used in an environment which is subject to strong electromagnetic interference.

- (7) Insofar as possible, position the GL220 input signal cables away from any other cables which are likely to be affected by electromagnetic interference.
- (8) For stabilized measurement, allow the GL220 to warm up for at least 30 minutes after turning it on.

### About Registered Trademarks





- Microsoft and Windows are registered trademarks or trademarks of Microsoft Corporation in the U.S. and elsewhere.
- Other company names and product names included in this manual are registered trademarks or trademarks of their respective companies.

## To Ensure Safe and Correct Use











- To ensure safe and correct use of the GL220, read this Manual thoroughly before use.
- After having read this Manual, keep it in a handy location for quick reference as needed.
- Do not permit small children to touch the GL220.
- The following describes important points for safe operation. Please be sure to observe them strictly.

### Conventions Used in This Manual

To promote safe and accurate use of the GL220 as well as to prevent human injury and property damage, safety precautions provided in this manual are ranked into the five categories described below. Be sure you understand the difference between each of the categories.

 <b>DANGER</b>	This category provides information that, if ignored, is highly likely to cause fatal or serious injury to the operator.
 <b>WARNING</b>	This category provides information that, if ignored, is likely to cause fatal or serious injury to the operator.
 <b>CAUTION</b>	This category provides information that, if ignored, could cause physical damage to the GL220.
 <b>HIGH TEMPERATURE</b>	This category provides information that, if ignored, is likely to cause burns or other injury to the operator due to contact with high temperature.
 <b>ELECTRICAL SHOCK</b>	This category provides information that, if ignored, is likely to expose the operator to electrical shock.

### Description of Safety Symbols

	The  symbol indicates information that requires careful attention (which includes warnings). The point requiring attention is described by an illustration or text within or next to the  symbol.
	The  symbol indicates action that is prohibited. Such prohibited action is described by an illustration or text within or next to the  symbol.
	 The  symbol indicates action that must be performed. Such imperative action is described by an illustration or text within or next to the  symbol.

# Safety Precautions



**WARNING**

**Be sure to securely connect the GL220's power cord.**

- After checking that the Power switch is turned off, connect the power cord's female plug to the GL220 and then connect its male plug into the electrical socket.
- Use of the GL220 without the power cord securely plugged into the electrical socket may result in electrical shock due to current leakage.
- Before running the GL220 using a DC power supply, be sure to ground the protective ground terminal (⚡) to avoid electrical shock and fire hazards. For grounding, use a ground wire with a diameter of at least 0.75 mm<sup>2</sup>. When using the GL220 in an environment where grounding is not possible, ensure that the voltage to be measured is no greater than 50 V (DC or rms).



Securely connect the power cord  
Make sure that the socket has a good protective ground

**If the GL220 generates smoke, is too hot, emits a strange odor, or otherwise functions abnormally, turn off its power and unplug its power cord from the electrical socket.**

- Use of the GL220 in such status may result in a fire hazard or electrical shock.
- After checking that smoke is no longer being generated, contact your sales representative or nearest Graphtec vendor to request repair.
- Never try to perform repair yourself. Repair work by inexperienced personnel is extremely dangerous.



Amateur repair prohibited

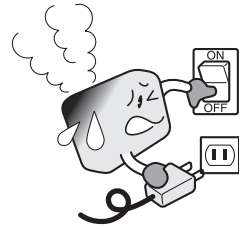

**Before turning on the GL220, ensure that the electric socket's supply voltage conforms to the GL220's power rating.**

- Use of a different supply voltage may cause damage to the GL220 or a fire hazard due to electrical shock or current leakage.



Use of a different supply voltage prohibited

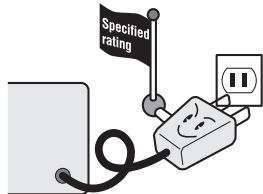

**Never disassemble or remodel the GL220.**

- Such action may cause a fire hazard due to electric shock or current leakage.
- Contact with a high-voltage component inside the GL220 may cause electric shock.
- If repair is required, contact your sales representative or nearest Graphtec vendor.



No disassembly



**Avoid using the GL220 in extremely dusty or humid places.**

- Such use may cause a fire hazard due to electrical shock or current leakage.



Use prohibited



Watch out for electrical shock



**Avoid using the GL220 in places where it may be exposed to water such as bathrooms, locations exposed to wind and rain, and so on.**



Avoid water



Watch out for electrical shock

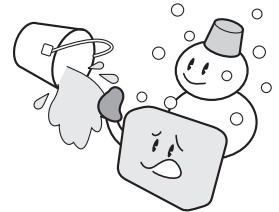

**Prevent dust or metallic matter from adhering to the power supply connector.**

- Adhesion of foreign matter may cause a fire hazard due to electrical shock or current leakage.



No foreign matter



Watch out for electrical shock

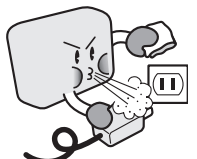

**Never use a damaged power cord.**

- Use of a damaged cord may result in a fire hazard due to electrical shock.
- If the cord becomes damaged, order a new one to replace it.



Unplug the power cord from the socket

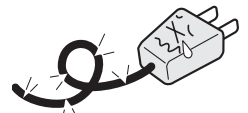

# Safety Precautions

## ⚠ CAUTION

**Do not use or store the GL220 in a location exposed to direct sunlight or the direct draft of an air conditioner or heater.**

- Such location may impair the GL220's performance.



Storage/Use prohibited

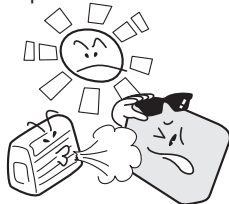

**Do not place coffee cups or other receptacles containing fluid on the GL220.**

- Fluid spilling inside the GL220 may cause a fire hazard due to electrical shock or current leakage.



Avoid water



Watch out electrical shock



**Do not use the GL220 in a location subject to excessive mechanical vibration or electrical noise.**

- Such location may impair the GL220's performance.



Use prohibited

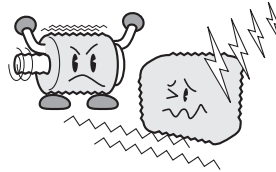

**To insert or disconnect the power cord or a signal input cable, grasp the power cord's plug or the signal input cable's connector.**

- Pulling the cord/cable itself damages the cord/cable, resulting in a fire hazard or electrical shock.



No pulling

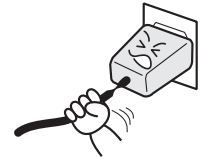

**If fluid or foreign matters enters inside the GL220, turn off the Power switch and disconnect the power cord from the electrical socket.**

- Use in such status may cause a fire hazard due to electrical shock or current leakage.
- Contact your sales representative or nearest Graphtec vendor to request repair.



Unplug the power cord from the socket

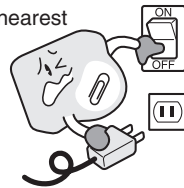

**Do not input voltage that exceeds the permissible input voltage range that is specified on the GL220's label.**

- Exceeding the specified voltage input range may cause electrical shock or a fire hazard.



Use prohibited

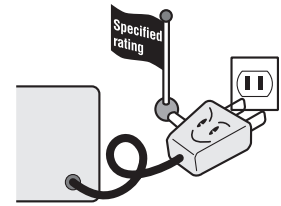

**Do not attempt to lubricate the GL220's mechanisms.**

- Such action may cause the GL220 to break down.



No lubrication

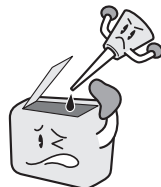

**Never clean the GL220 using a volatile solvent (such as thinner or benzene).**

- Such action may impair the GL220's performance.
- Clean off any soiled areas using a soft dry cloth.



No volatile solvents

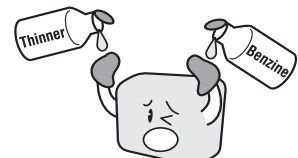

# CONTENTS

Introduction.....	I
Notes on Use .....	I
About Registered Trademarks.....	II
To Ensure Safe and Correct Use.....	i
Conventions Used in This Manual.....	i
Description of Safety Symbols .....	i
Safety Precautions .....	ii
<b>1 General Description .....</b>	<b>1-1</b>
1.1 Overview.....	1-2
1.2 Features.....	1-2
1.3 Operating Environment.....	1-3
Ambient Operating Conditions .....	1-3
Warming-up Before Use.....	1-3
Configuration When in Use .....	1-3
1.4 Notes on Temperature Measurement .....	1-4
1.5 Notes on Using the Monitor .....	1-4
1.6 Changing the Display Language.....	1-4
<b>2 Checks and Preparation .....</b>	<b>2-1</b>
2.1 Checking the Outer Casing.....	2-2
2.2 Checking the Accessories .....	2-2
2.3 GL220 Nomenclature and Functions .....	2-3
2.4 Connecting the Power Cable and Turning on the Power.....	2-4
Connecting to an AC Power Supply .....	2-4
Connecting to a DC Power Supply.....	2-5
2.5 Connecting the Signal Input Cables .....	2-6
Terminal Configuration and Signal Types .....	2-6
2.6 Logic Alarm Cable Connection and Functions.....	2-7
Logic Alarm Cable Connection.....	2-7
Internal Equivalent Circuit of the Input/Output Circuit .....	2-8
Wiring.....	2-9
2.7 Attaching USB Memory .....	2-10
Inserting a USB Memory.....	2-10
2.8 Connecting to a PC.....	2-11
Connection Using a USB Cable .....	2-11
2.9 Using the Battery Pack (the B-517 Option).....	2-12
Mounting the Battery Pack .....	2-12
Charging the Battery .....	2-13
2.10 Connecting the Humidity Sensor (Option) .....	2-14
2.11 Precautions to Observe When Performing Measurement.....	2-15
2.12 Noise Countermeasures .....	2-16
2.13 Setting the Date and Time .....	2-17
How to Recharge the Rechargeable Battery.....	2-17
How to Set the Date and Time .....	2-17
<b>3 Settings and Measurement.....</b>	<b>3-1</b>
3.1 Window names and functions.....	3-2
3.2 Key Operation .....	3-7
(1) SPAN/TRACE/POSITION .....	3-7
(2) TIME/DIV .....	3-8

(3) MENU .....	3-8
(4) QUIT (LOCAL) .....	3-8
(5) Direction keys .....	3-8
(6) ENTER.....	3-8
(7) FAST FORWARD key (KEY LOCK).....	3-9
(8) START/STOP (USB Drive Mode).....	3-9
(9) REVIEW.....	3-10
(10) DISPLAY .....	3-10
(11) CURSOR (ALARM CLEAR) .....	3-11
(12) FILE .....	3-11
3.3 Operation Modes .....	3-13
(1) Free Running .....	3-13
(2) Capturing .....	3-14
(3) Dual View Replaying.....	3-14
(4) Replaying.....	3-15
3.4 Setting Menus.....	3-16
<b>4 Specification .....</b>	<b>4-1</b>
4.1 Standard Specifications .....	4-2
Standard Specifications .....	4-2
Internal memory devices .....	4-3
PC Interface .....	4-3
Monitor .....	4-3
Input Unit Specifications.....	4-4
4.2 Function Specifications.....	4-5
Function Specifications .....	4-5
Trigger Functions.....	4-5
External Input/Output Functions .....	4-6
4.3 Accessory/Option Specifications .....	4-7
Control Software .....	4-7
Accessories.....	4-7
Battery Pack B-517 (Option) .....	4-7
Humidity Sensor B-530 (Option) .....	4-7
4.4 External Dimensions.....	4-9
<b>Index .....</b>	<b>S-1</b>





# CHAPTER 1 General Description

---

This chapter provides a general description of the GL220 and its features.

- 1.1 Overview
- 1.2 Features
- 1.3 Operating Environment
- 1.4 Notes on Temperature Measurement
- 1.5 Notes on Using the Monitor
- 1.6 Changing the Display Language

## 1.1 Overview

The GL220 (with color monitor and internal memory) are compact, lightweight data loggers.

GL220 are equipped with an Internal memory to enable the direct capture of a large volume of data to USB memory. Furthermore, the data loggers can be connected to a PC via USB to enable on-line settings, measurement, and data capture.

## 1.2 Features

### Input

- Adoption of an M3 screw type terminal facilitates wiring.
- The GL220 enables settings to be made using dedicated keys and interactive menus, using just one hand.

### Display

- With the GL220's high-resolution 4.3-inch wide TFT color liquid crystal display, you can confirm the waveforms of measured data and each channel's settings at a glance.

### Data Capture

- A large volume of measured data can be saved to a USB memory.
- The high-capacity internal memory enables measurement for a long term without the use of USB memory.
- The USB memory device can be removed and replaced without terminating data capture operations. This allows any part of the data to be extracted during long capture operations.
- Internal memory used for the built-in memory maintains captured data even after the power is turned off.
- The Internal memory can be used with disk images thus multiple data items can be maintained.
- For voltage and humidity measurements, data can be captured up to a sampling speed of 10 ms/1ch by setting fewer channels for measurement (sampling speed is 100 ms and above for temperature measurements).
- The new ring memory capture function maintains latest data even after capturing for a long term. (You need to set how long you want to keep data.)

### Data Control & Processing

- The application software provided lets you set conditions and monitor data on a computer using the USB interface.
- The application software allows you to control multiple GL220 units from a single computer to easily perform multi-channel measurements.
- The USB drive mode function enables the GL220's internal memory to be recognized as an external drive by your PC. (Connect the GL220 to your PC and turn on the power supply to the GL220 while holding down the [START] key.)
- Captured data can be read from the application software to files and displayed for processing.
- Data can be transferred off-line to a computer using USB memory.

## 1.3 Operating Environment

This section explains the operating environment for the GL220

### Ambient Operating Conditions

- (1) Ambient temperature and humidity (the GL220 must be operated within the following ranges.)
  - Temperature range: 0 to 45°C (0 to 40°C when battery pack is mounted)
  - Humidity range: 5 to 85% RH
- (2) Environment (do not use in the following locations.)
  - A Location such as being exposed to direct sunlight
  - Locations exposed to salty air, corrosive gases, or organic solvents
  - Dusty locations
  - Locations subject to vibration or impact
  - Locations subject to voltage surge or electromagnetic interference such as lightning or electric furnaces
- (3) Installation category (overvoltage category)
  - The GL220 belongs to Installation Category II defined in IEC60664-1.
  - Never use the GL220 for Installation Category III or IV.
- (4) Measurement category
  - The GL220 belongs to Measurement Category I defined in IEC61010-1.
  - The GL220 cannot be used for Measurement Category II, III, or IV.



If condensation occurs...

Condensation occurs in the form of water droplets on the device surfaces and interior when the GL220 is moved from a cold to a warm location. Using the GL220 with condensation will cause malfunctioning.

Wait until the condensation has disappeared before turning on the power.

### Warming-up Before Use

The GL220 should be allowed to warm up with the power turned on for approximately 30 minutes to ensure that it operates according to the specified performance.

### Configuration When in Use

It is recommended to use the GL220 while it is laid flat or inclined on the stands.

#### **Usage Configuration**

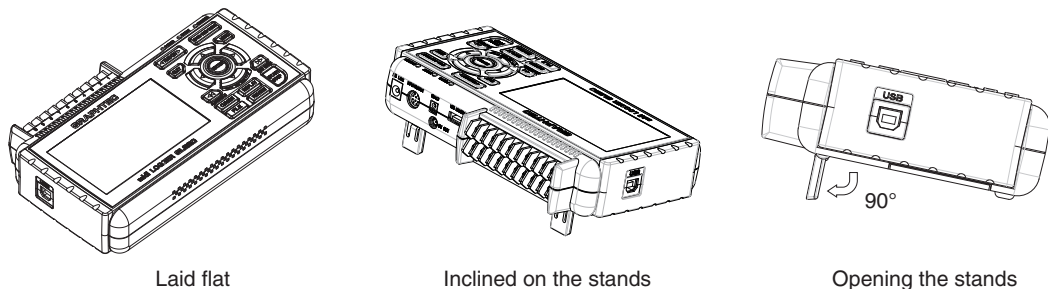

To prevent possible malfunction, do not block the air vents of the GL220.

If you use the GL220 in other position than described in the above, the measurement accuracy may not meet the specifications.

To prevent possible toppling, use both of the stands of the GL220 when you place it inclined.

Use the GL220 with both of the two stands open as shown in the figure above.

## 1.4 Notes on Temperature Measurement

Please observe the following precautions when performing temperature measurement.

- Do not block the air vents. Always provide a space of at least 30 cm on all sides of the GL220.
- For stabilized temperature measurement, allow the GL220 to warm up for at least 30 minute safter turning it on.
- Exposure of the input terminals to direct drafts, direct sunlight, or abrupt changes in temperature may impair the equilibrium of the input parts and result in measurement errors. To measure temperature in such an environment, take appropriate countermeasures such as changing the installation site of the GL220.
- If measured values fluctuate due to external noise, try the countermeasures described on page 2-16.

## 1.5 Notes on Using the Monitor

The monitor is an LCD display unit, and so the display will vary depending on the operating environment.



If the screen saver function is used, it will operate and clear the screen if no operations are performed during the preset time. If the screen saver operates, press any key to restore the display.



- Condensation may form on the LCD screen if the GL220 is moved from a cold to a warm location. If this occurs, wait until the LCD screen warms up to room temperature.
- The LCD screen is manufactured to extremely high precision. Black dots may appear, or red, blue, and green dots may not disappear. Likewise, streaks may appear when viewed from certain angles. These phenomena are due to the LCD screen construction, and are not signs of a fault.

## 1.6 Changing the Display Language

You can choose either English, Japanese, French, German, Chinese, or Korean as the language displayed on the screen. The default display language is set to English when the GL220 is shipped overseas. To change the display language, see the instructions in “OTHR:Language”.

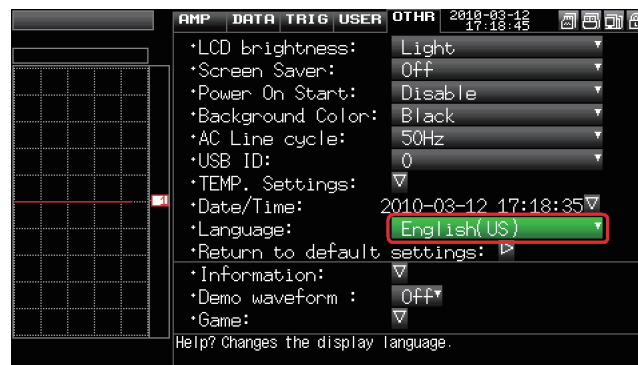



# CHAPTER 2 Checks and Preparation

---

This chapter explains how to check the GL220's external casing and accessories, and how to prepare the GL220 for operation.

- 2.1 **Checking the Outer Casing**
- 2.2 **Checking the Accessories**
- 2.3 **GL220 Nomenclature and Functions**
- 2.4 **Connecting the Power Cable and Turning on the Power**
- 2.5 **Connecting the Signal Input Cables**
- 2.6 **Connecting the External I/O Cable**
- 2.7 **Attaching USB Memory**
- 2.8 **Connecting to a PC**
- 2.9 **Using the Battery Pack (the B-517 Option)**
- 2.10 **Connecting the Humidity Sensor (Option)**
- 2.11 **Precautions to Observe When Performing Measurement**
- 2.12 **Noise Countermeasures**
- 2.13 **Setting the Date and Time**

## 2.1 Checking the Outer Casing

After unpacking, check the GL220's outer casing before use. In particular, please check for the following:

- Surface scratches
- Other flaws such as stains or dirt

## 2.2 Checking the Accessories

After unpacking, check that the following standard accessories are included.

### Standard Accessories

Item	Remarks	Quantity
Quick Start Guide	GL220-UM-85x	1
CD-ROM	User's Manual, Application software	1
AC cable/AC adapter	100 to 240 VAC, 50/60 Hz	1

### Optional Accessories

Item	Option number	Remarks
Logic alarm cable	B-513	2m, Bare tips
DC drive cable	B-514	2m, Bare tips
Battery pack	B-517	7.4V/2200mAh 17Wh
Humidity sensor *1	B-530	3 m, with dedicated power connector
Humidity sensor power box	B-542	For connection with 10 humidity sensors: Built to order
M3 screws with flat washers (60)	B-543	60 per set
USB memory 2GB	B-550	2GB
Shunt resistor 250 $\Omega$	B-551	250 $\Omega$ , Rated power of 1 W, Maximum service voltage of 15.8 V, Built to order
T-type thermocouple *2	JBS-7115-5M-T	5-m length, 5 thermocouples per set, wire diameter of 0.32, 1.0 x 1.6 x 5000 mm
K-type thermocouple *2	JBS-7115-5M-K	5-m length, 5 thermocouples per set, wire diameter of 0.32, 1.0 x 1.6 x 5000 mm
Extra fine K-type thermocouple (TC200/TD1000), 5 per set	ST-55K-TC-1.2M	Tip wire diameter of 0.127, 0.5 x 0.7 x 200 mm, Relay part 1 m, 5 per set
Needle-shape K-type thermocouple	RIC-410	-100 to 300°C, Class 1, Cord length: 1.1 m
Stationery-surface K-type thermocouple	RIC-420	-30 to 400°C, Class 2, Cord length: 1.1 m
L-type stationery-surface K-type thermocouple	RIC-430	-30 to 600°C, Class 2, Cord length: 1.1 m
Mini-connector for K-type thermocouple (5 per set)	RIC-440	5 per set, Connectable thermocouple: Wire diameter of 0.65 mm, End terminal: M3Y terminal
Mini-connector for K-type thermocouple (2 per set)	RIC-441	2 per set, Connectable thermocouple: Wire diameter of 0.65 mm, End terminal: M3Y terminal
Mini-connector for T-type thermocouple (5 per set)	RIC-450	5 per set, Connectable thermocouple: Wire diameter of 0.65 mm, End terminal: M3Y terminal
Mini-connector for T-type thermocouple (2 per set)	RIC-451	2 per set, Connectable thermocouple: Wire diameter of 0.65 mm, End terminal: M3Y terminal

\*1: Allowable temperature range: -25 to +80°C

\*2: Sold only in Japan.



## 2.3 GL220 Nomenclature and Functions

This section describes the names and function of parts of the GL220.

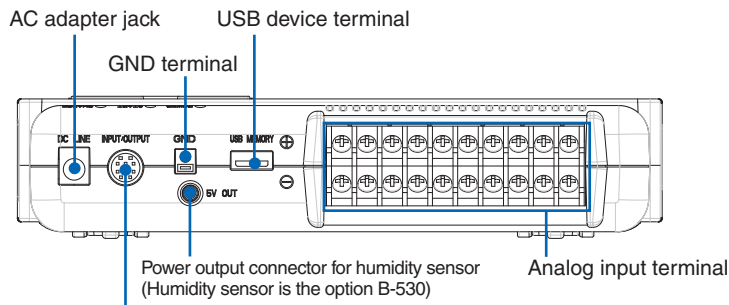
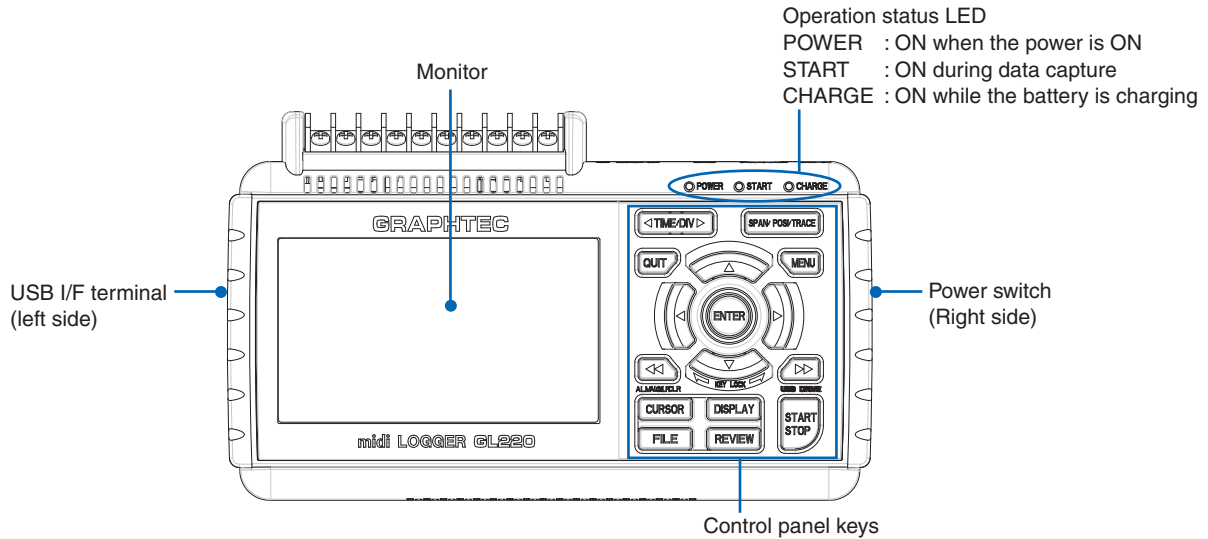

External input/output terminals

- LOGIC/PULSE
- EXT TRIG/SAMPLE
- ALARM

Logic alarm cable(When using the B-513 option)

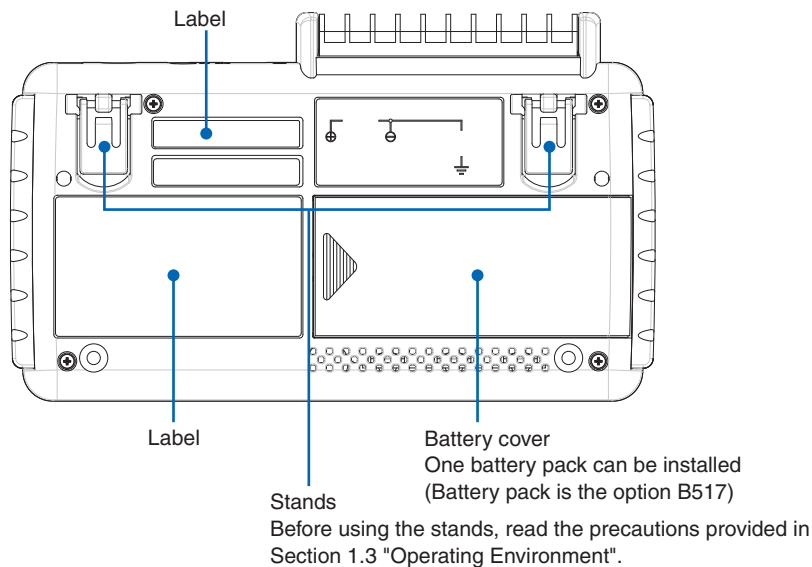

## 2.4 Connecting the Power Cable and Turning on the Power

This section describes how to connect the power cable and turn on the power. The connection method will vary depending on the type of power supply used.

### Connecting to an AC Power Supply

Use the AC cable and AC adapter that are provided as accessories.

#### **CAUTION**

Be sure to use the AC adapter that is supplied as a standard accessory.

- (1) Plug the AC cable into the AC adapter.

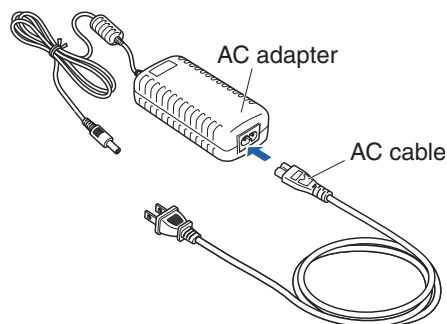

- (2) Connect the output side of the AC adapter to the connector on the GL220.

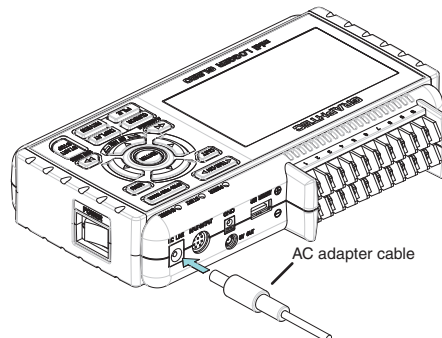

- (3) Using the flat-blade screwdriver, press against the minus (-) button above the GND terminal, while connecting the grounding cable to the GL220. Connect the other end of the cable to ground.

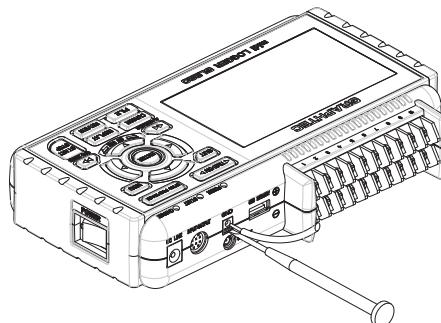

- (4) Plug the AC cable into the mains power outlet.
- (5) Press the power switch on the GL220 to the ON side to turn on the power.

#### **CAUTION**

Always connect the GND terminal and refer to the safety precautions. The GL220 must be grounded even when connected to other devices and sharing a common ground level.

## Connecting to a DC Power Supply

Use the optional DC drive cable (B-514).

### CAUTION

Use a power supply within the 8.5 to 24 VDC range (26.4 VDC max.).

- (1) Configure the tip of the DC drive cable (B-514: 2m) to enable it to be connected to the DC power supply.
- (2) Connect the DC output side to the power supply connector on the GL220.

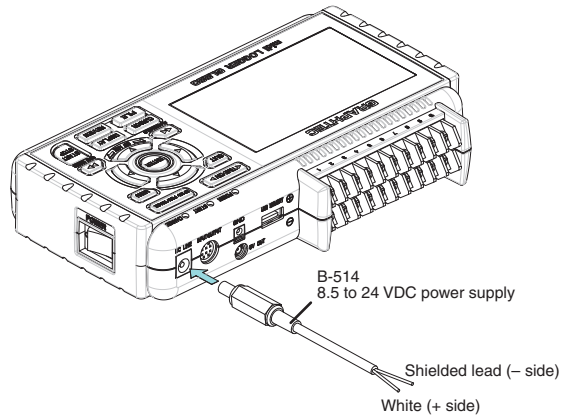

- (3) Connect the DC input side to the DC power supply.

### CAUTION

Be sure to check the polarity of the wire tips when performing wiring.

- (4) Press the power switch on the GL220 to the ON side to turn on the power.

## 2.5 Connecting the Signal Input Cables

This section describes how to connect the signal input cables.

### Terminal Configuration and Signal Types

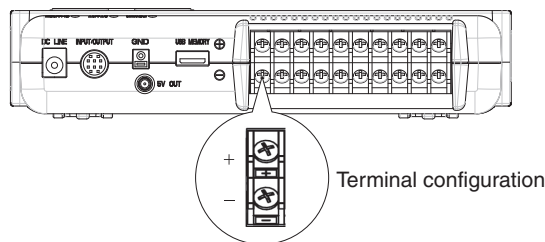
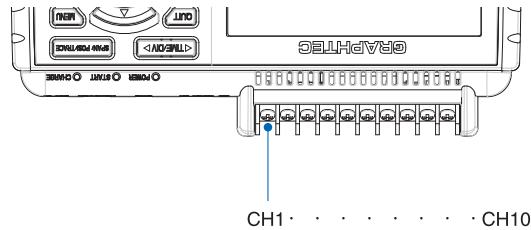

#### Voltage input

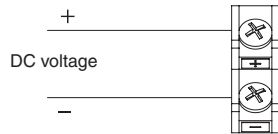

#### Thermocouple input

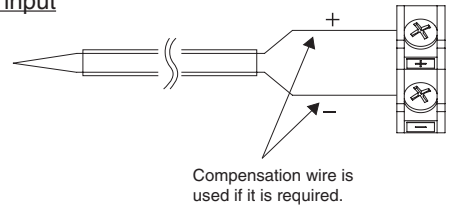

Resistance temperature detector  
not available

#### Current input

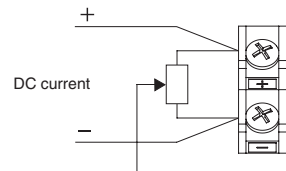

Shunt resistor  
Ex: The current is converted to the voltage in the shunt register.  
For 4 to 20mA current input, installing 250 ohms (0.1%) resistor for converting 1 to 5V.  
\* 250 ohms shunt register is the option B551.

- +.....High-voltage terminal (terminal for high-voltage input signals)
- .....Low-voltage terminal (terminal for low-voltage input signals)

Item	Description
Input configuration	Isolated input, scanning
Analog voltage	20, 50, 100, 200, 500 mV/F.S.; 1, 2, 5, 10, 20, 50 V/F.S.; 1-5V
Thermocouples	K, J, E, T, R, S, B, N, W (WRe 5-26)
A/D resolution	16-bit (Effective resolution: About 1/40,000 of the +/- range)
Filter	Off, 2, 5, 10, 20, 40 Filter operation is on a moving average basis. The average value of the set sampling count is used. If the sample interval exceeds 5 seconds, the average value of data obtained in a sub-sample (5 seconds) is used.

## 2.6 Logic Alarm Cable Connection and Functions

### Logic Alarm Cable Connection

The logic alarm cable (B-513: Option) enables logic/pulse input, external trigger input, external sampling input, and alarm signal output.

Connect the logic alarm cable (B-513: Option) to the external input/output terminal as shown below.

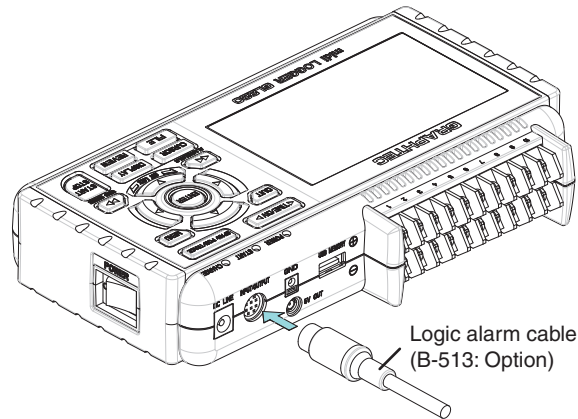

### Logic/Pulse Specifications

Item	Description
Number of input channels	4
Input voltage range	0 to +24V max. (single-ended ground input)
Threshold level	Approx. +2.5V
Hysteresis	Approx. 0.5 V (+2.5 to +3 V)

\* Logic input and pulse input are switchable.

### Trigger input/external sampling input specifications

Item	Description
Number of input channels	1
Input voltage range	0 to +24V max. (single-ended ground input)
Threshold level	Approx. +2.5V
Hysteresis	Approx. 0.5 V (+2.5 to +3 V)

### Alarm output specifications

Item	Description
Number of output channels	4
Output format	Open collector output +5V, pull-up resistance 10 K $\Omega$ * See the next page for details on alarm output.

### Internal Equivalent Circuit of the Input/Output Circuit

• Alarm Output

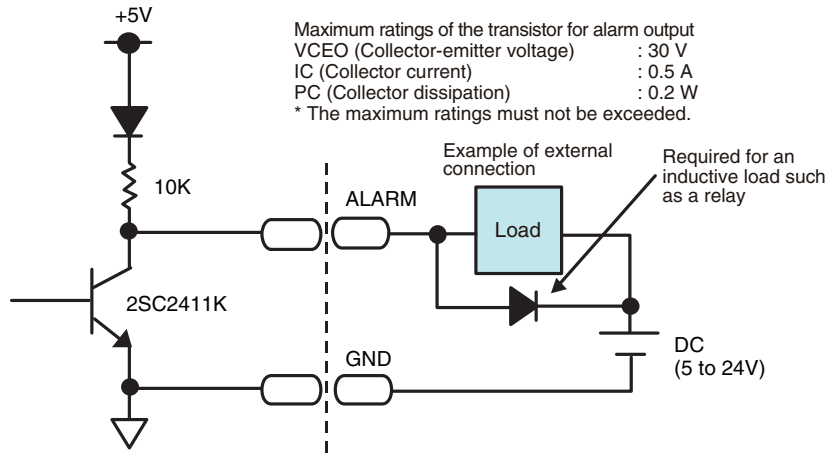

• Logic/Pulse Input

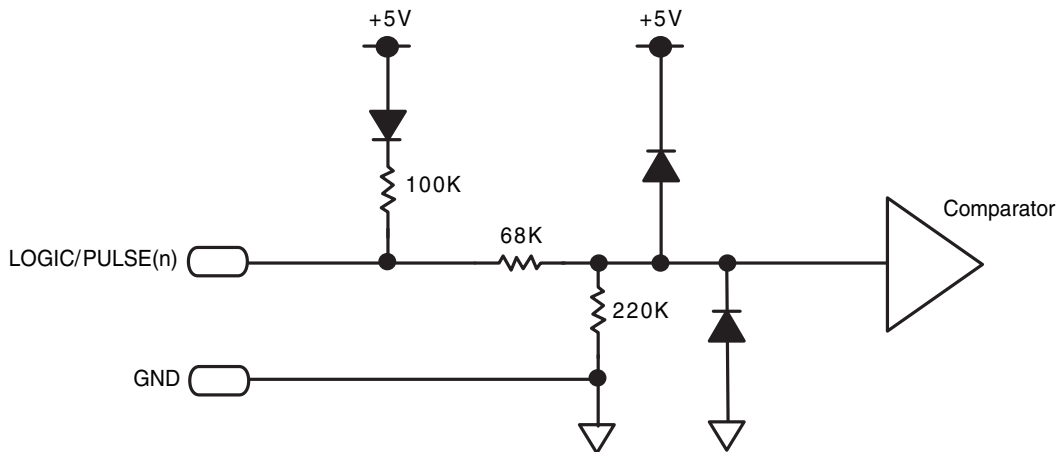

• Trigger Input

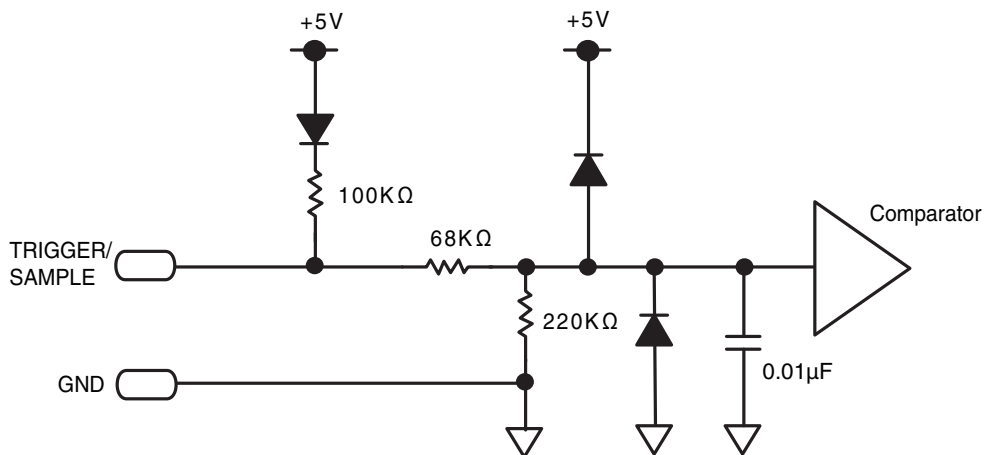

Wiring

Cable tips are bare tips. Perform wiring for the necessary functions.

Signal Name	Channel Number	Wire Color
Logic/Pulse output	1	Orange with red dotted line
	2	Orange with black dotted line
	3	Gray with red dotted line
	4	Gray with black dotted line
Alarm output	1	White with red dotted line
	2	White with black dotted line
	3	Yellow with red dotted line
	4	Yellow with black dotted line
Trigger input/external sampling input		Pink with red dotted line
GND		Pink with black dotted line
		Shielded

\* Logic and pulse are switchable.

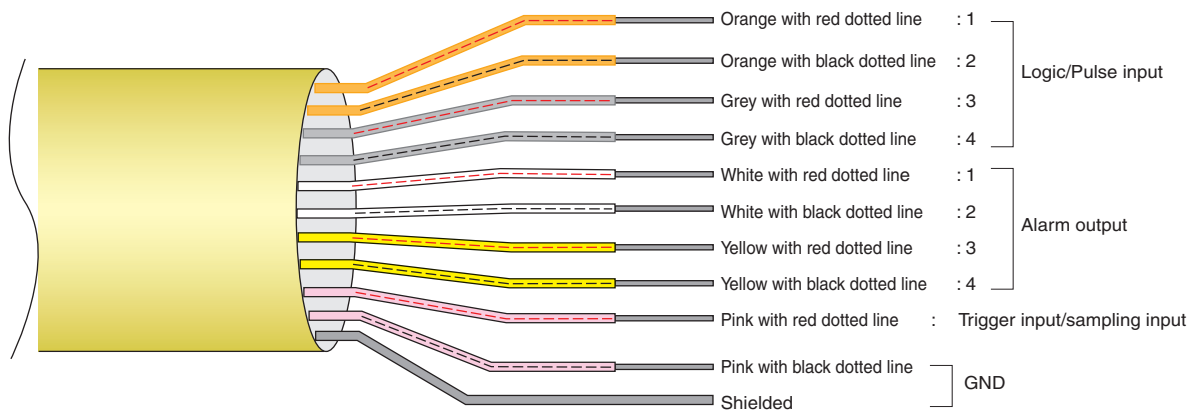

## 2.7 Attaching USB Memory

Attaching USB memory to the GL220 allows you store measured data directly.

### CAUTION

Adequate precautions against static electricity must be taken when handling USB memory.

### Inserting a USB Memory

Attach the USB memory to the USB memory port.

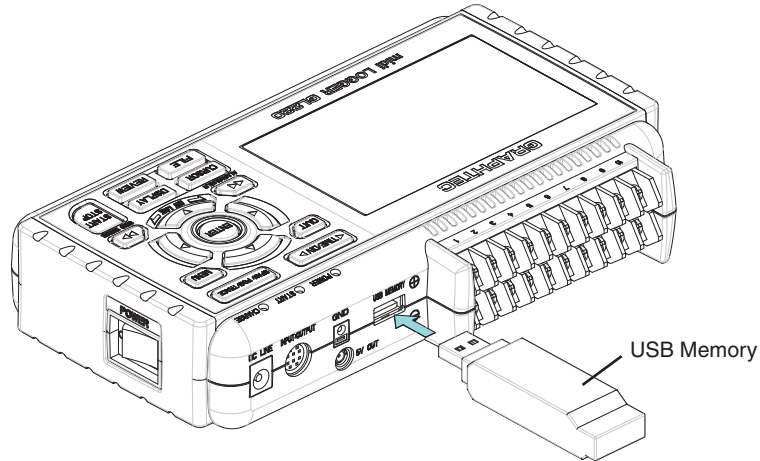

### CAUTION

When you attach the USB memory to GL220A, be careful during handling so as not to bump or drop the unit.

<Supported USB Memory Specifications>

- Power supply : +5 V
- Power consumption : 250 mA or below
- Capacity : no limit (each file must be smaller than 2 GB)

\* USB memory with security functions such as fingerprint authentication or having a connector without a shell (metallic part) cannot be used.

Use the B-550 (option) as USB memory.

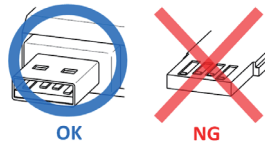



## 2.8 Connecting to a PC

Use the USB cable to connect the GL220 to a PC.

### Connection Using a USB Cable

Use the USB cable to connect the GL220 to a PC.

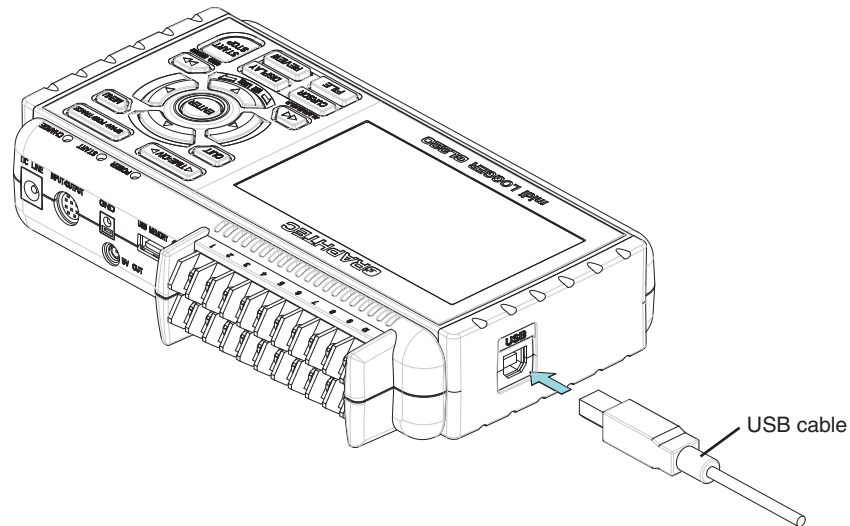

If the USB cable is used, the USB driver must be installed in your PC. Please refer to "USB Driver Installation Manual" in the accessory CD-ROM for the installation procedure.

Use the A-B USB cable to connect the GL220 to a PC.

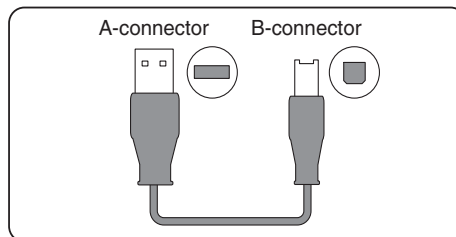

## 2.9 Using the Battery Pack (the B-517 Option)

- The B-517 battery is the only battery type that can be used with the GL220.
- Refer to the specifications (P.4-7) for information on the battery run time.
- The operating temperature range of the GL220 with a battery pack mounted is as follows:  
Running on battery : 0 to 40°C  
Battery being charged : 15 to 35°C

### Mounting the Battery Pack

(1) While lightly pushing the grip of the battery cover, slid the cover in the direction indicated by the arrow.

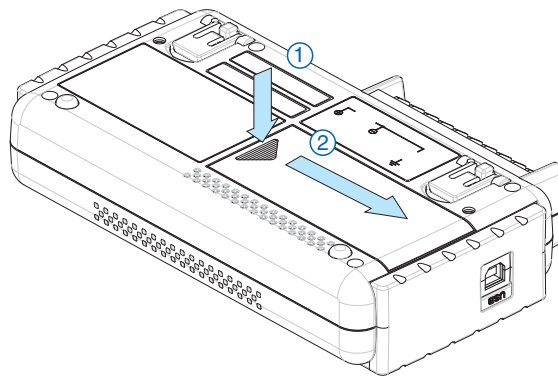

(2) Attach the lithium-ion battery (B-517).

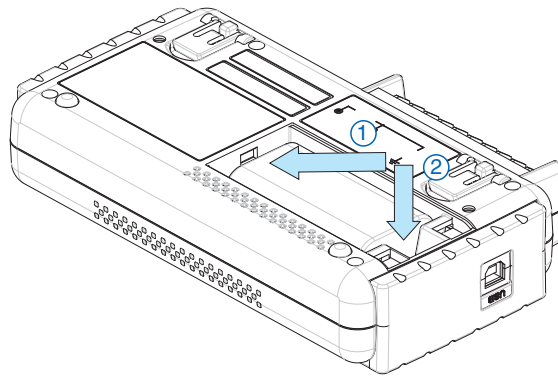

(3) Attach the battery cover.

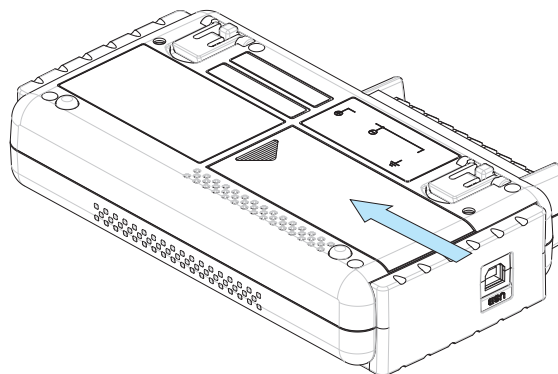

## Charging the Battery

Expected time required for charging: • Approx. 4 hours

The battery pack is charged by mounting it in the GL220, attaching AC adapter to the GL220.

- (1) Mount the battery pack in the GL220 (see the previous section for the mounting procedure).
- (2) Turn on the power to the GL220. (Please see Section 2.4, “Connecting the Power Cable and Turning on the Power”).
- (3) The CHARGE LED lights.

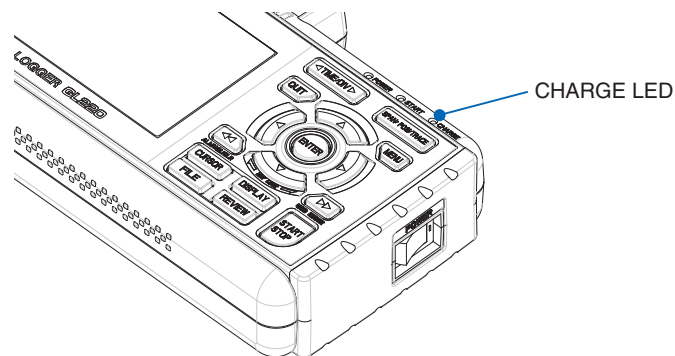

### CHECKPOINT

- The GL220 is equipped with a temperature monitor function which starts automatic charging as soon as it is cooled down. Therefore, depending on the internal temperature, charging may not be performed immediately.
- When charging is attempted while the power is ON, charging may not be performed immediately even if the temperature environment conforms to the specification. In such a case, set the Screen Saver settings to ON or perform charging while the power is OFF.
- If input is being made directly from the DC power supply instead of the AC adapter, the DC voltage must be at least 16V.
- The operating temperature range during charge is from 15 to 35°C.

## 2.10 Connecting the Humidity Sensor (Option)

Connect the + and - lead wires of the humidity sensor (the B-530 option) to the desired terminals, and then insert the round connector into the 5V OUT connector on the GL220.

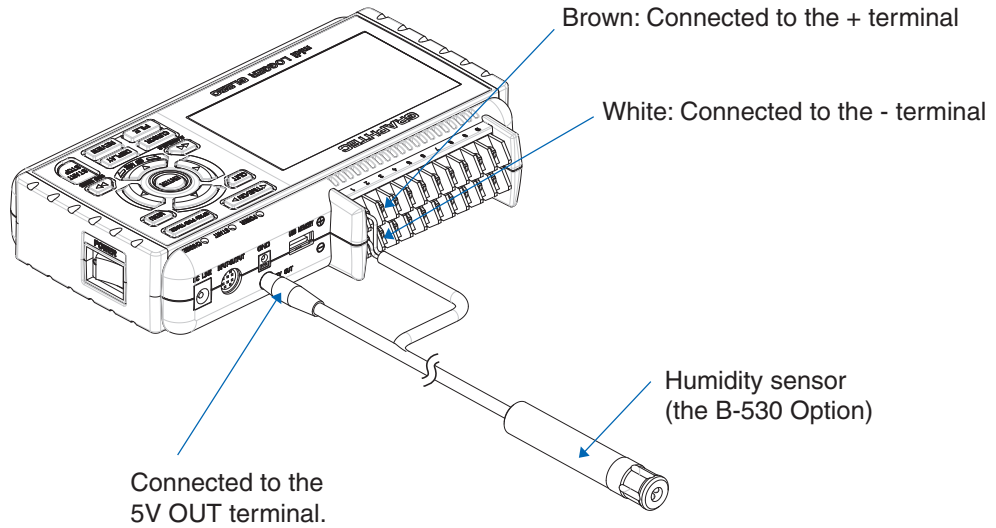

**CAUTION**

Do not use the sensor in a strong electrolyte environment. Measured results may not satisfy to the stated.

## 2.11 Precautions to Observe When Performing Measurement

Please be sure to read the following carefully in order to prevent electric shocks or shorts.

### **!** DANGER

- Do not apply voltage of 60Vp-p or above between the analog input section and main unit, or between analog input channels.
- Do not apply high-voltage high-frequency signals (50 kHz and above).
- Be sure to use only the AC adapter provided as a standard accessory. The rated power supply range for the adapter is 100 to 240 VAC, and the rated frequency is 50/60 Hz. Do not use any other voltages.

#### • Maximum input voltage

If a voltage exceeding the specified value is input, the semiconductor relay in the input section will be damaged. Never input a voltage exceeding the specified value even for a moment.

<Between +/- terminals (A) >

- Maximum input voltage : 60Vp-p

<Between input terminal/input terminal (B) >

- Maximum input voltage : 60Vp-p
- Withstand voltage : 350 Vp-p at 1 minute

<Between input terminal/GND (C) >

- Maximum input voltage : 60Vp-p
- Withstand voltage : 350 Vp-p at 1 minute

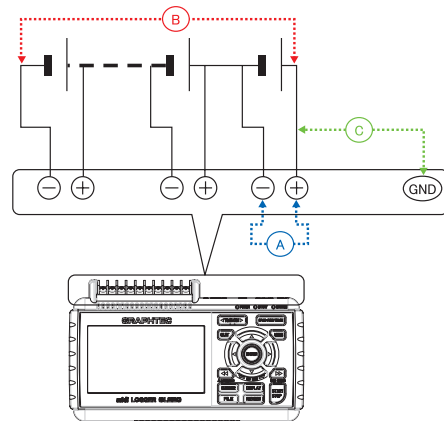

#### • Input Circuit Diagram for Analog Input (Voltage, Thermocouples)

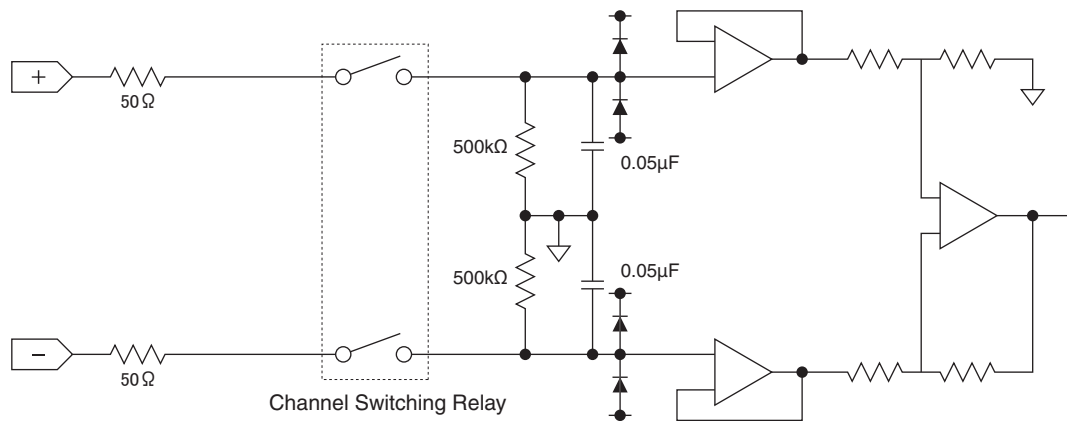

### **!** CAUTION

Capacitors have been incorporated into the input circuit to increase the noise elimination capability.

After voltage measurement, when the inputs have been disconnected, there will still be some electric charge remaining. Before starting another measurement operation, short-circuit the + and - terminals to enable self-discharge.

The GL220 has a scan system.

While in the status (open) in which signals are not input to the input terminal, measured results may be influenced by signals from other channels.

In such a case, turn OFF the input setting or short circuit +/-.

If signals are input correctly, measured results are not influenced by other channels.

## 2.12 Noise Countermeasures

- Be sure to connect the chassis GND of the object to be measured.  
Ensure that the chassis GND wire of the measurement object is connected to a good ground.

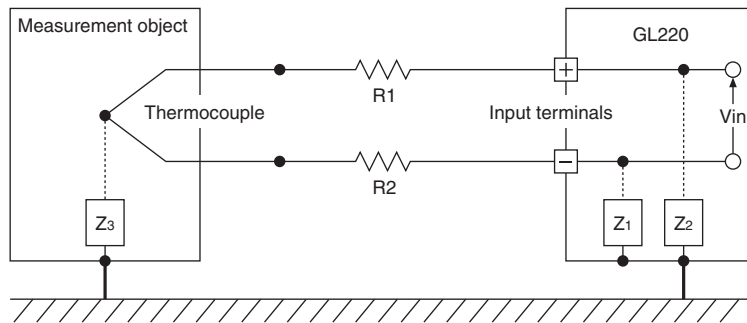

- Connect the signal chassis GND and the measurement device chassis ground.  
Use a short, thick lead to connect the chassis GND of the measurement object to the GL220's chassis GND. It will be even more effective if the ground potentials are the same.

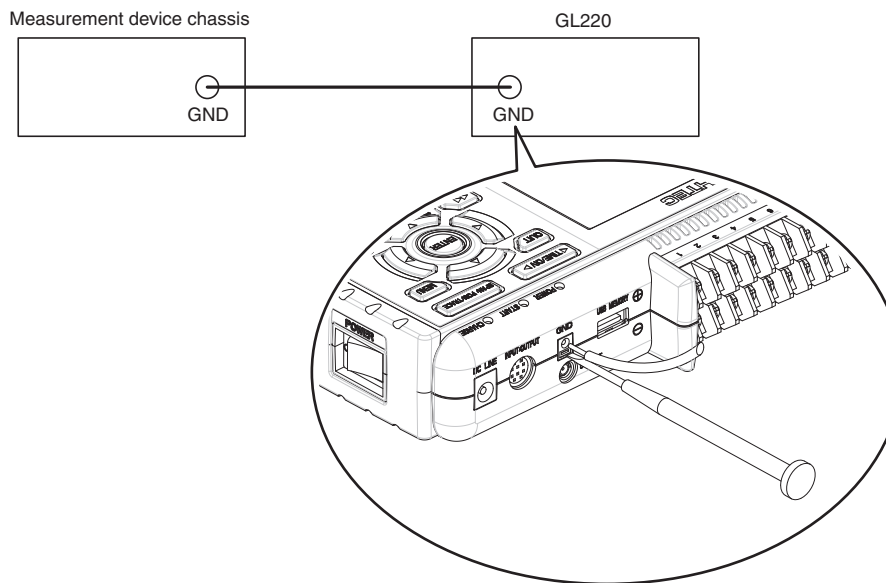

### CHECKPOINT

#### Noise countermeasures

If measured values fluctuate due to extraneous noise, conduct the following countermeasures.

(Results may differ according to noise type.)

Ex 1 : Connect the GL220's GND to ground.

Ex 2 : Connect GL220's GND to measurement object's GND.

Ex 3 : In the AMP settings menu, set filter to any setting other than "OFF".

Ex 4 : Operate GL220 with batteries (Option: B-517).

Ex 5 : Set the sampling interval which enables GL220's digital filter.

In the OTHR menu, set the frequency of the AC line used.

Refer to page 3-35 for details.

## 2.13 Setting the Date and Time

If you are using the GL220 for the first time, charge the internal rechargeable battery and then make the date and time settings.

### CAUTION

If the GL220 is not used for a period of approximately six months, the internal rechargeable battery may be discharged and the date and time may revert to the initial settings. If this happens, recharge the battery before using the GL220.

### How to Recharge the Rechargeable Battery

Using the AC adapter provided, connect the GL220 to a mains power outlet, turn on the power switch, and then leave the GL220 connected for at least 24 hours.

### How to Set the Date and Time

Press the [MENU] key, display the “OTHR” screen, and then set the date and time at the Date/Time Settings sub-menu. For details, see “Date/Time” on page 3-35.

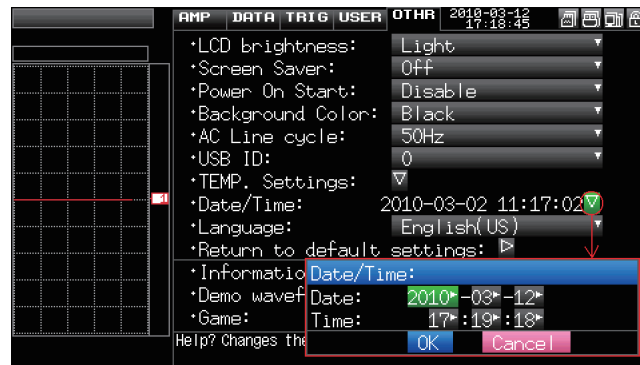





# CHAPTER 3 Settings and Measurement

---

This chapter describes the setting and measurement procedures for the GL220.

- 3.1 Window names and functions**
- 3.2 Key Operation**
- 3.3 Operation Modes**
- 3.4 Setting Menus**

## 3.1 Window names and functions

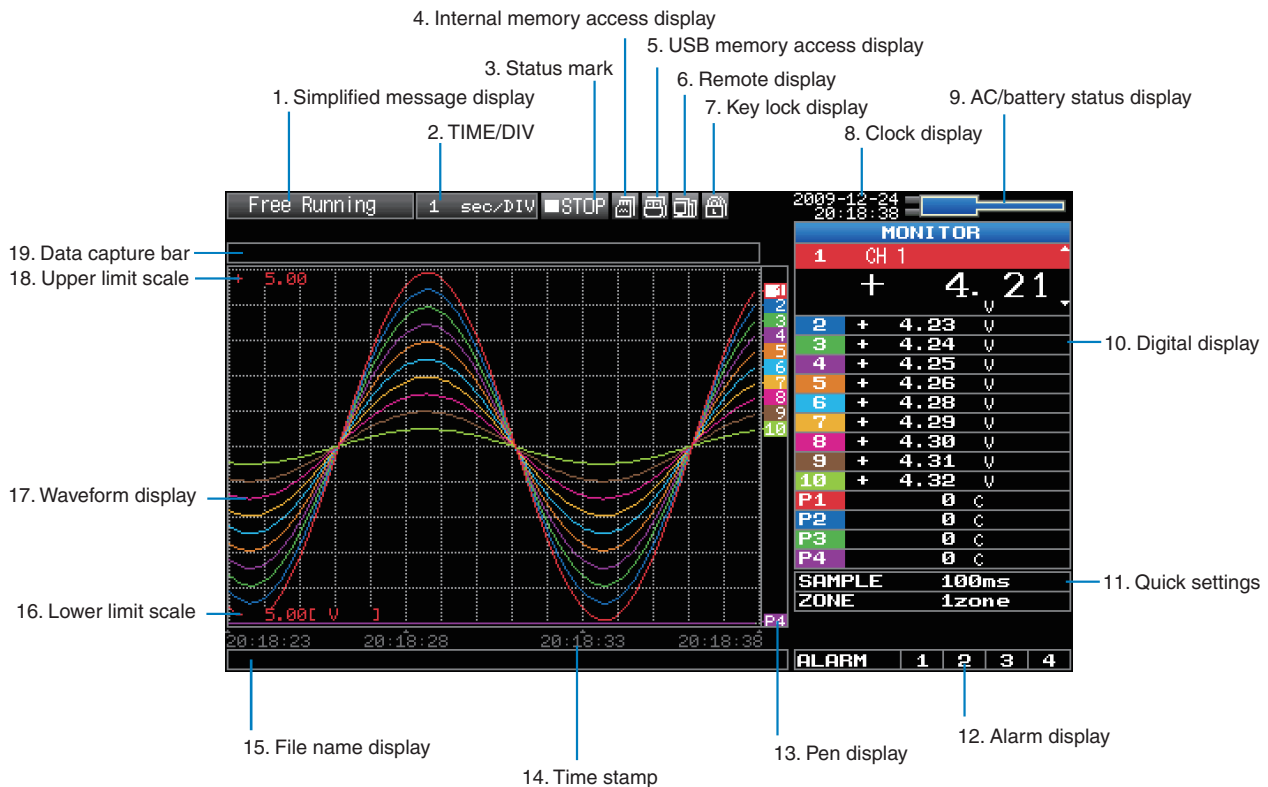

### 1. Simplified message display

Displays the operation status of the GL220.

<b>Free Running</b>	: Appears in the start up status or when data is not being captured.
<b>Armed</b>	: Appears while waiting for trigger generation after measurement is started.
<b>Memory Recording</b>	*: Appears when data is being captured in the internal memory.
<b>Recording USB mem</b>	*: Appears when data is being captured in the USB memory.
<b>Writing Disk</b>	*: Capture stop processing or other cases when data is being written to the built-in internal memory or USB memory
<b>Finished</b>	: Appears when the GL220 waits for you to press the Start/Stop key to stop it after data capture.
<b>Memory Review</b>	: Appears while the data in the internal memory is being replayed.
<b>Replaying USB mem</b>	: Appears while the data in the USB memory is being replayed.
<b>Backup Failed</b>	: Appears when backup fails (e.g. when the USB memory specified as the backup destination has been removed).
<b>Demo Wave Mode</b>	: Appears when a demo waveform is being displayed, not measurement data.

\* Refer to page 3-28 for details on the data capture such as a trigger and repeat.

\* Refer to page 3-24 for details on the memory used for capture.





### **CAUTION**

Do not turn off the power while the simplified message is "Memory Recording" "Recording USB mem" or "Writing Disk" (those with an asterisk (\*) above). Data will become corrupt and will not be captured. Operate the GL220 after checking that the status mark is "STOP."

## 2. Time/DIV display

Displays the current time scale.



## 3. Status mark

-  : Appears when neither capture nor replay is in progress.
-  \*: Appears when data is being captured in the internal memory or USB memory.
-  \*: Appears when waiting for a trigger during capturing and the stop key after capturing.
-  \*: Appears when data in the internal memory or USB memory is being replayed.

### CAUTION

Do not turn off the power or remove the USB memory while the status mark is other than STOP (those with an asterisk (\*) in the above). Data may become corrupt and inaccessible. Operate the GL220 after checking that the display is "STOP"



## 4. Internal memory access display

-  : The internal memory is not accessed.
-  : The internal memory is being accessed.

### CAUTION

Do not turn off the power of the GL220 while the internal memory is being accessed. Data may become corrupt and inaccessible.



## 5. USB memory access display

-  : No USB memory is inserted.
-  : USB memory is inserted but is not accessed.
-  : USB memory is being accessed. Do not remove the USB memory.



### CAUTION

Do not remove the USB memory or turn off the power of the GL220 while the USB memory is being accessed. Data may become corrupt and inaccessible.

## 6. Remote display

-  : Indicates local mode. Operations can be conducted on the GL220.
-  : Indicates remote mode. With some exceptions, operations must be conducted on a PC. When you cancel the connection on the application (GL220\_820APS), the GL220 is automatically sent back to local mode. If local mode is not entered, press the "QUIT" key.

## 7. Key lock display







-  : Not in key lock status. Normal operations are enabled.
-  : Key lock status. All the keys are locked. Refer to page 3-47 for details on the key lock.

### 8. Clock display

Displays the current date and time.

Refer to page 3-35 for details on setting the date and time.

### 9. AC/battery display

-  : Running on AC or DC power supply.
-  : Running on the battery. The remaining battery power is 100 to 91%.
-  : Running on the battery. The remaining battery power is 90 to 61%.
-  : Running on the battery. The remaining battery power is 60 to 31%.
-  : Running on the battery. The remaining battery power is 30 to 11%.
-  : Running on the battery. The remaining battery power is 10% or below.

#### CAUTION





- Data capture automatically stops when the remaining battery power drops to 10% or below during data capture.
- The power is automatically turned off when the remaining battery power is 0%.
- If the power has been turned off due to battery shortage, inputting AC power will not turn on the power. Turn off the power switch once and then turn it on again.
- Use the remaining battery power as a guideline because it is not accurate.

This indicator does not guarantee the operating time with battery.

### 10. Digital display

Displays the input value of each channel. Use the SPAN/TRACE/POSITION keys to switch the display. Use the  $\nabla/\Delta$  key to select the channel you want to activate (enlarged display).

The waveform of the active channel is displayed at the top.

-  : Displays the input value.
-  : The span of the active channel can be changed using the  $\langle\rangle$  keys.
-  : The position of the active channel can be changed using the  $\langle\rangle$  keys.
-  : The ON or OFF of the active channel display can be changed using the  $\langle\rangle$  keys.

Refer to page 3-7 for details.

For a channel with a calculation mark as shown below, calculation between channels is ON.



### 11. Quick settings

Displays items available for easy operation. Use the  $\nabla/\Delta$  keys to activate the Quick setting and the left/right keys to change values.

\* The "SAMPLE" item cannot be changed during data capture.

### 12. Alarm display

Displays the alarm output terminal status.

The number with which an alarm has occurred is displayed in red. The channel with the alarm cause has a red input value in the digital display area.

### 13. Pen display

Displays the position of each channel signal, trigger and alarm range.

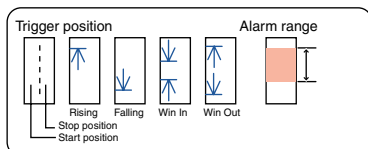

## 14. Time stamp

Displays the time stamp of a currently displayed waveform as time.

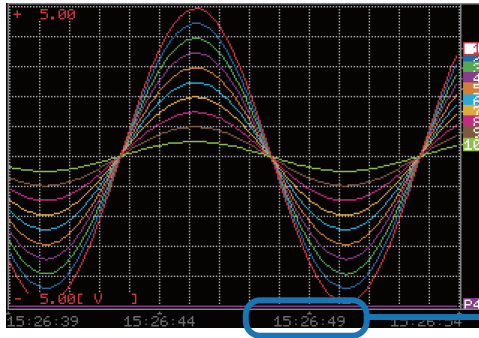

This indicator shows that the measurement data was captured at 15:26:49.

## 15. File name display

(1) During data capture

A capture file name is displayed during capture.

```
<MEM>091224\091224-172622_UG.GBD
```

\* If the ring capture setting is ON, a file name displayed during capture ends with "\_RINGx" (x represents a number) but the actual file name does not include "\_RINGx".

In the above figure, if the ring capture is set to ON, the file name during capture will be displayed, for example, as "<MEM>091225\091225-130620\_UG\_RING4.GBD" but the actually created file will be "<MEM>091225\091225-130620\_UG.GBD".

\* Refer to page 3-25 for details on the ring capture setting.

(2) During data replay

Information on the time axis of the cursor is displayed during replay.

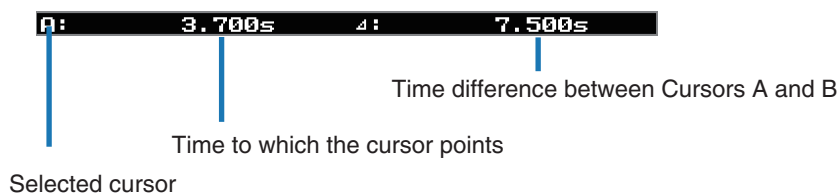

## 16. Lower limit scale

Displays the lower limit scale of the currently active channel.

## 17. Waveform display

Displays the waveform of the input signal.

## 18. Upper limit scale

Displays the upper limit scale of the currently active channel.

### 19. Data capture bar

(1) During data capture

Displays the elapsed time and the memory usage status.

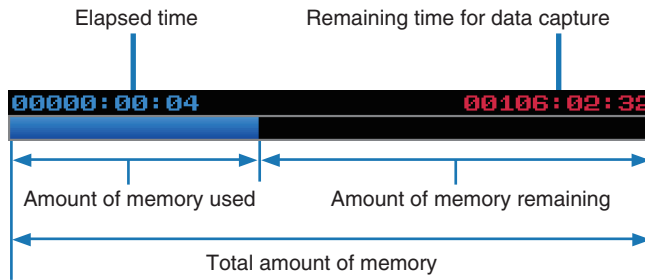

If, for example, 256 MB USB memory is inserted and about 96 MB is used before data capture, the total amount of memory is 256 MB, the amount of memory used is about 96 MB, and the amount of memory remaining is about 160 MB. As time elapses during data capture, the amount of used memory increases and the amount of remaining memory decreases.

The remaining time for data capture shows a length of time during which data capture is available with the amount of remaining memory. If the amount of remaining memory is more than 2 GB, however, this part shows remaining time during which data capture is available with one 2 GB file.

\* Remaining time more than 99999 hours is displayed as "++++:++:++".

(2) During data replay

Displays the display position, cursor position, and trigger position graphically.

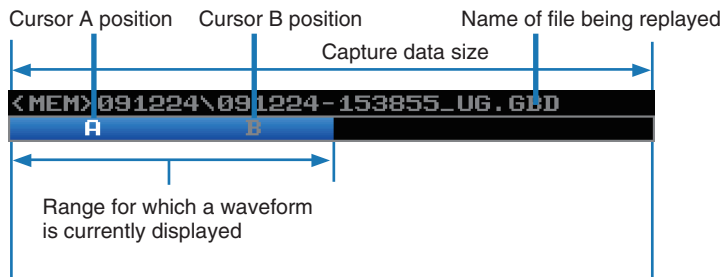

## 3.2 Key Operation

This section describes key operation.

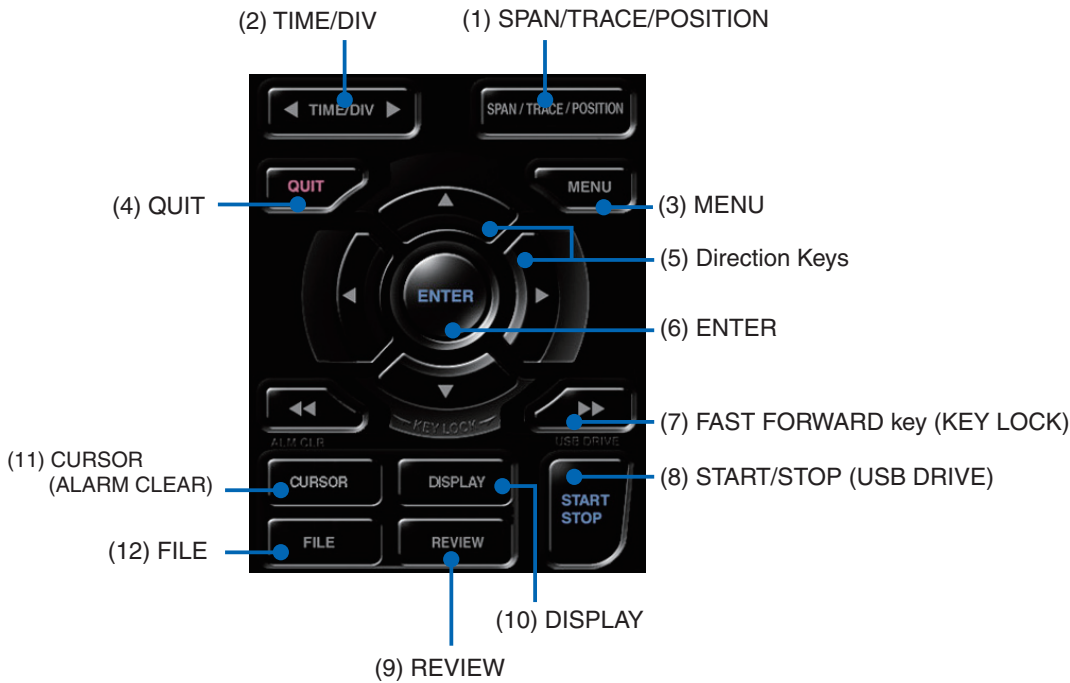

### (1) SPAN/TRACE/POSITION



Switches the display in the digital display.

Used to change the settings related to waveform display during Free Running (when stopped), data capture and data replay.

Pressing this key will switch displays as shown below.

MONITOR	SPAN	POSITION	TRACE
<p>Displays digital values (default status)</p>	<p>Allows changing of the span value (waveform amplitude)</p> <ul style="list-style-type: none"> <li>Channel change : <math>\nabla</math> keys</li> <li>Amplitude change : <math>\triangleleft</math> keys</li> <li>Change available : Voltage 8 steps / Temperature 6 steps</li> </ul>	<p>Allows changing of the position (waveform up/down position)</p> <ul style="list-style-type: none"> <li>Range can be changed in units of 10%</li> <li>Channel change : <math>\nabla</math> keys</li> <li>Position change : <math>\triangleleft</math> keys</li> <li>Change available : 10% steps of range</li> </ul>	<p>Allows turning ON/OFF of the waveform display</p> <ul style="list-style-type: none"> <li>Channel change : <math>\nabla</math> keys</li> <li>Position change : <math>\triangleleft</math> keys</li> <li>Change available : ON/OFF</li> <li>* Data is captured even if OFF is set.</li> </ul>

\* When ALL is set, setting values for CH1 is reflected on other channels.

When CH1 is OFF, ALL Cannot be set.

## (2) TIME/DIV



Press the left/right key of the TIME/DIV key to change the time axis display width.

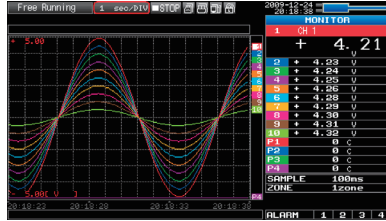

## (3) MENU



Open the settings window to capture data. For details on settings, see “3.4 Setting Menus” on page 3-16.

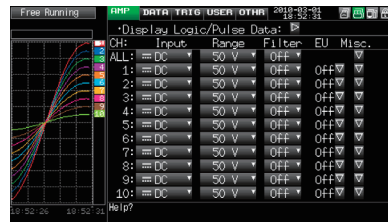

## (4) QUIT (LOCAL)



This key is primarily used for the following operations.

- To cancel a setting during menu configuration.
- To return to the MONITOR window when the SPAN/TRACE/POSITION window is displayed.
- To cancel remote status (in which keys are disabled) through interface control.
- To close the menu screen.
- To quit data replay.

## (5) Direction keys



This key is primarily used for the following operations.

- To move a menu or setting item during menu configuration.
- To move the cursor during replay.
- To move the active channel in the Waveform + Digital and Digital + Calculation Display screens (▽△ keys).
- To change the setting of SPAN/TRACE/POSITION (<|> keys).
- To change the Quick setting (<|> keys).
- To change the channel to be displayed in the Digital + Calculation Display screen (<|> keys).

## (6) ENTER

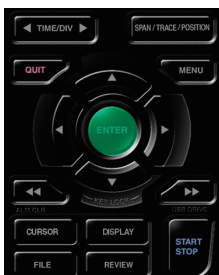

This key is primarily used for the following operations.

- To finalize setting items during menu configuration or open submenus.



### (7) FAST FORWARD key (KEY LOCK)



This key is primarily used for the following operations.

- To move the cursor at high speed during replay.
- To change the operation mode in the file box.
- To set key lock (Hold down the left/right FAST FORWARD key for at least two seconds. press again to unlock)

A password for canceling the key lock can be specified. See page 3-47 for details.

- To change the display mode in the Digital + Calculation Display screen

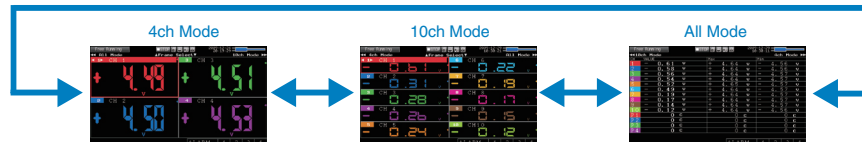

### (8) START/STOP (USB Drive Mode)

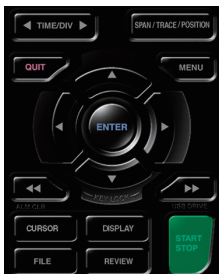

This key performs the following two operations:

<Starts/stops capture>

- During Free Running, starts capture.
- During capture, stops capture.

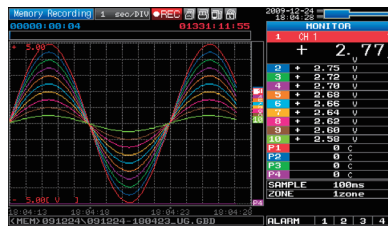

### USB Drive Mode Operation Procedure

In USB Drive Mode, the internal memory is recognized by the PC as an external storage media.

Since the internal memory is recognized as a removal disk, this mode facilitates file manipulation such as transfer and deletion.

1. Use a USB cable to connect the GL220 and a PC.
2. While pressing the GL220 START/STOP key, turn the power ON.
3. The external storage media is recognized by the PC and data exchange becomes possible.

\* In USB Drive Mode, the display on the GL220 becomes as follows:



### CAUTION

- To exit USB Drive Mode, turn off and on the power again.
- In USB Drive Mode, no operation including data capture and data replay is available.
- To use USB Drive Mode, a USB driver must be installed in your PC. A USB driver and the USB driver installation manual are stored on the supplied CD-ROM. Install the USB driver according to this manual. The drive letter "D:" used in the manual location (D:\USB Driver\English\GL-USB-UM152.PDF) should be read as that of a drive on which the CD-ROM is mounted. The drive letter depends on your PC.

(9) REVIEW



This key is used to replay captured data.

- During Free Running, replays captured data.

The screen used to specify the data replay source file appears; specify the file you want to replay.

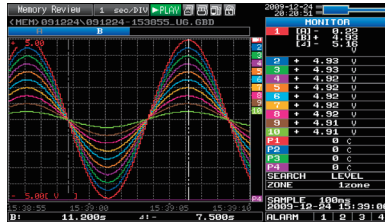

- While capturing data, recently captured data is replayed in two windows.

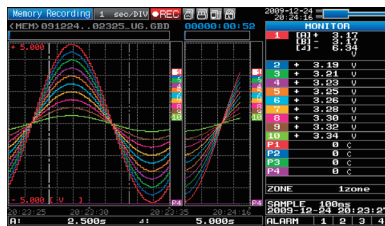

(10) DISPLAY



This key is used to switch the window mode.

You can switch the window mode during Free Running (when capturing is stopped) and Capturing. Pressing this key switches the window display as follows:

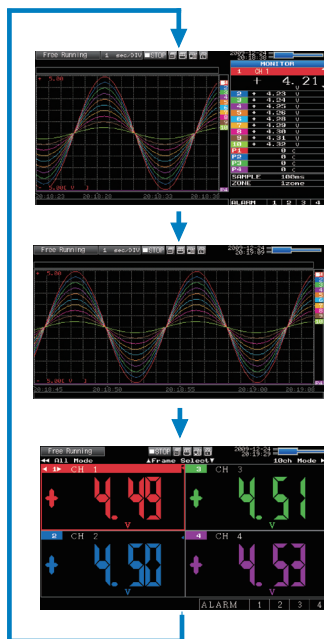

<Waveform + Digital Screen>

Displays the waveform and the digital values.

The setting can be changed using the SPAN/TRACE/POSITION keys.

<Expanded Waveform screen>

Displays only the waveform expanded in full screen mode.

<Digital + Calculation Display screen>

Displays digital values and two calculation results in large letters. The calculation settings can be made using the Data menu.

\* Refer to page 3-27 for details.

- Use the <<|>> FAST FORWARD keys to change the display mode.

The calculation results are displayed only in All Mode.

\* Refer to page 3-9 for details on All Mode.

### (11) CURSOR (ALARM CLEAR)



- This key is used to toggle between cursors A and B during replay.

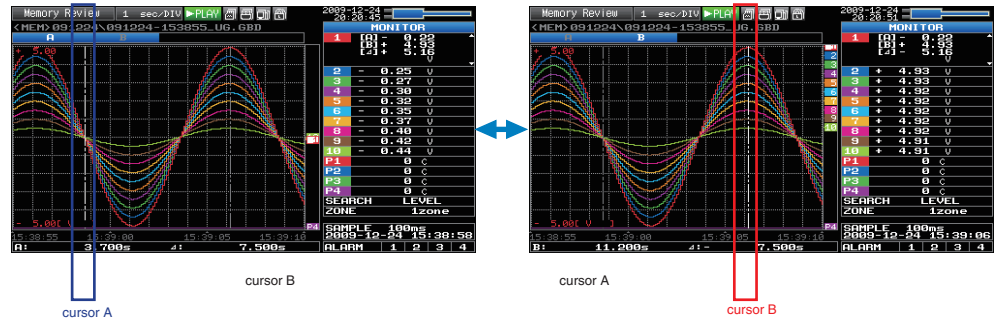

The selected cursor turns white, and the other one turns gray.

- When the alarm setting is “Hold generated Alarm”, the maintained alarm is cleared.

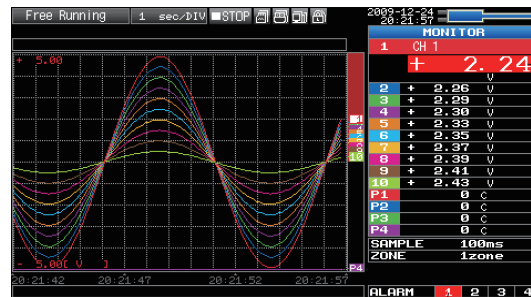

Alarm-generated channels

Alarm output terminal status  
 Black : Alarm is not issued  
 Red : Alarm is issued

### (12) FILE



Performs file-related operations.

- This key is use for operations related to the Internal memory and USB device (copy and delete).
- Copies the window.
- Saves all data or data between cursor A and cursor B during replay (can be set during replay only)
- Saves or reads the currently set condition into the USB device. (can be set during Free Running only).
- Exchanges USB memory during data capture (can be set only while data is captured to USB memory).

### Basic Procedures Used in Settings

The following are basic operation procedures for settings.



1. Press the MENU key to open each menu.
2. Use the  $\nabla\Delta\triangleleft\triangleright$  key to move the cursor to the items you want to set.
3. Press the ENTER key to display a list of setting values.
4. Use the  $\nabla\Delta\triangleleft\triangleright$  key to select a setting value.
5. Press the ENTER key to confirm the value.

The above explanation shows the basic procedure that may be used for each setting. Please follow the procedure indicated by each menu.

## 3.3 Operation Modes

You can check the system operation status in the simplified message display.

operation	operation	simplified message display
Free Running	Start up status or data is not being captured	Free Running
Capturing	Data is being captured in the main memory or USB memory.	Memory Recording USB Memory Recording
Dual View Replaying	The current waveform display and data on capturing is being replayed	Memory Recording USB Memory Recording
Replaying	Captured data is being replayed	Memory Review USB Memory Review

Operation status transition

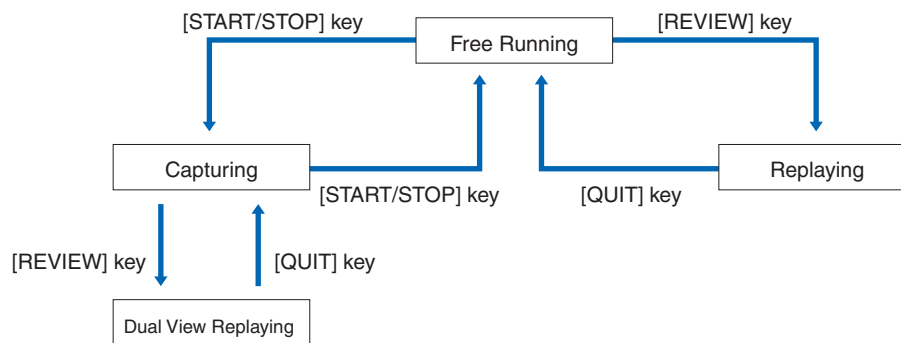

### (1) Free Running

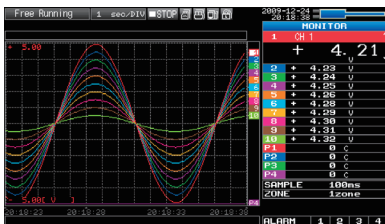

When in Free Running status, you primarily set up the system to capture data.

You can check the current input signal as a waveform or digital values.

Operations available during Free Running

Measurement parameters settings	The MENU key is used to change various setting items in configuration menus.
SPAN/TRACE/POSITION	The SPAN/TRACE/POSITION key is used to change settings.
Display mode	The DISPLAY key is used to change the display mode.
File operations	The FILE key is used to perform file-related operations.
Data replay	The REVIEW key is used to replay captured data.
Time axis change	The TIME/DIV key is used to change the time axis.

(2) Capturing

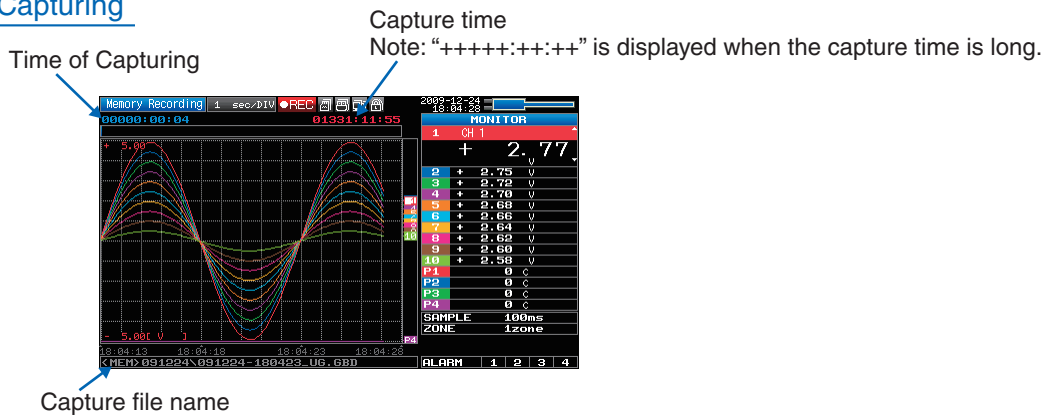

During data capture, data is captured into the Internal memory or USB device.  
 You cannot use the MENU key to change the setting.

Operations available during capture

SPAN/TRACE/POSITION	The SPAN/TRACE/POSITION key is used to change settings.
Display mode	The DISPLAY key is used to change the display mode.
Dual View replay	The REVIEW key is used to replay captured data in two windows at the same time.
Save to device	While data is replayed in two windows, the FILE key is used to save data to a device.
Setting check	The MENU key is used to change the settings.
Time axis change	The TIME/DIV key is used to change the time axis.

(3) Dual View Replaying

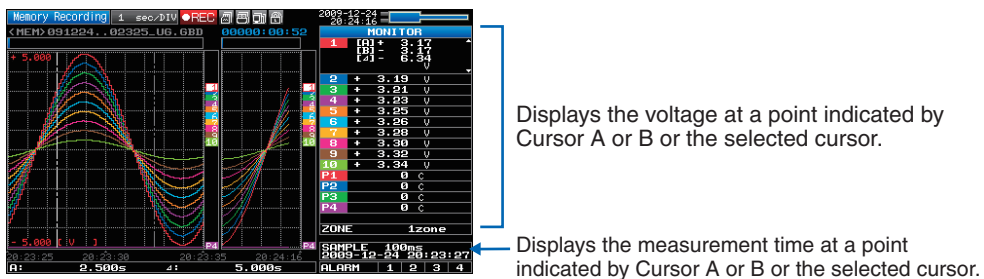

You can replay data during capture.

Waveform on the right side is the current captured data and the left side is previously captured data. You can use the Direction keys (<D>) to move the cursor to captured data to check digital values.

Operations available during dual view replaying

Moving cursor	The CURSOR key is used to switch between cursors A and B. The <D> or <D>>> keys are used to move the cursors.
Save to device	The FILE menu is used to save data to a device. (During capture, data up to the present or data between cursors can be saved to a separate file. While capture to the internal memory is in progress, use this feature to save data to USB memory without stopping capture.)
Screen copy	The FILE menu is used to copy the screen.

#### (4) Replaying

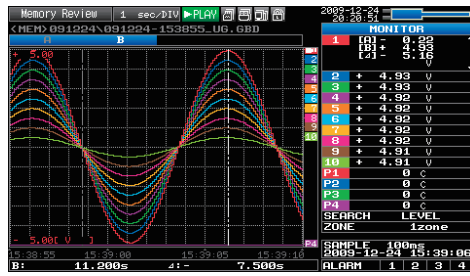

Displays the voltage at a point indicated by Cursor A or B or the selected cursor.

Displays the measurement time at a point indicated by Cursor A or B or the selected cursor.

Displays the captured data.

Operations available during replaying

SPAN/TRACE/POSITION	The SPAN/TRACE/POSITION key is used to change settings.
Menu operations during data replay	The MENU key is used to move the cursor, search data and set calculation.
Moving cursors	The CURSOR key is used to switch between cursors A and B. The < > or << >> keys are used to move the cursors
File operations	The FILE key is used to save either all data or the data between the cursors.
Time axis change	The TIME/DIV key is used to change the time axis.

## 3.4 Setting Menus

When you press the MENU key during Free Running, the following menu screens appear. The menu screens are classified by the tab for each setting item.



### (1) AMP settings

This menu is used to specify input signal-related settings.

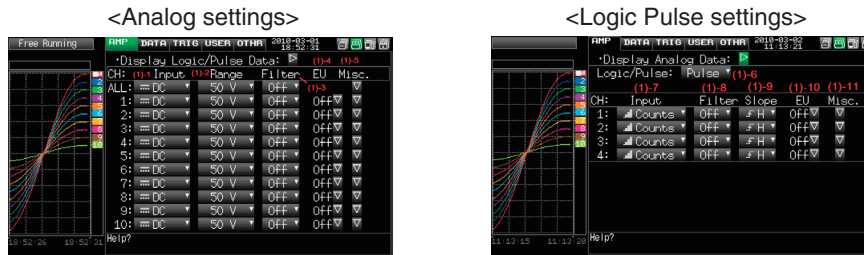

Setting		Selections available		
Input		Off, Voltage, Temperature, Humidity		
Range	[Voltage]	20, 50, 100, 200, 500 mV; 1, 2, 5, 10, 20, 50, 1-5 V		
	[Temperature]	TC-K, TC-J, TC-T, TC-R, TC-E, TC-B, TC-S, TC-N, TC-W		
Filter		Off, 2, 5, 10, 20, 40		
EU (Scaling settings)	Function	Off, On		
	Meas. Value	Upper limit	Set numeric value	
		Lower limit	Set numeric value	
	EU output value	Upper limit	Set numeric value	
		Lower limit	Set numeric value	
	Dec pt	EU output upper limit x 1, x 10, x 100, x 1000		
	Select	Current, length, area, volume, speed, acceleration, frequency, weight, work, pressure, flow rate, temperature		
	Choose	(The selections vary depending on the unit selected in the above.)		
	Arbitrary unit		Text input	
	Misc.	Inter-CH	Function Off, On	
Op Settings		Operation	CH-X (+, -, x, /) CH-Y	
		Scaling	/1000000, /1000, x1, x1000, x1000000	
		Upper/Lower limit	Set numeric value	
		Dec pt	x1, x10, x100, x1000, x10000	
		Select	Current, length, area, volume, speed, acceleration, frequency, weight, work, pressure, flow rate, temperature	
Choose		(The selections vary depending on the unit selected in the above.)		
Arbitrary unit		Text input		
Span settings		Upper limit	Set numeric value	
		Lower limit	Set numeric value	
Annotation string		Text input (Max. 31 characters)		
Waveform color setting		0 to 31 for each of red, green, blue (RGB)		
Amplitude Setting		1 to 8 dots		
Perform Auto Zero ADJ.		▷ Press right key to execute.		
Reset Auto Zero ADJ.		▷ Press right key to execute.		
Logic/Pulse		Off, Logic, Pulse		
[Logic]	Filter	Misc.	Waveform color setting 0 to 31 for each of red, green, blue (RGB)	
		[Pulse]		
	Input		Off, Revolution counts, Counts, Inst.	
	Filter		Off, On	
	Slope		↑ H, ↓ L	
	EU	Function		Off, On
		Meas. Value		Set numeric value
		EU output value		Set numeric value
		Select		Current, length, area, volume, speed, acceleration, frequency, weight, work, pressure, flow rate, temperature
		Choose		(The selections vary depending on the unit selected in the above.)
	Arbitrary unit		Text input	
	Misc.	Waveform color setting		0 to 31 for each of red, green, blue (RGB)
		Amplitude Setting		1 to 8 dots



### Switching displays

Analog and logic/pulse can be switched as shown below.

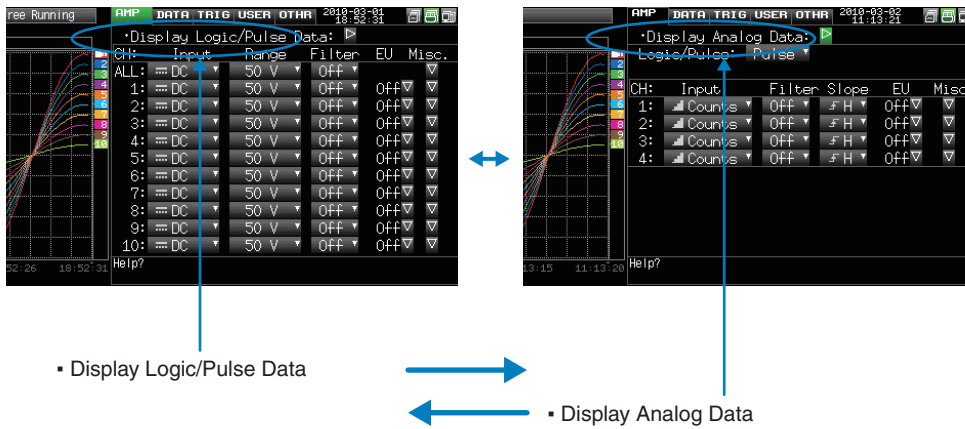

### Analog settings

Specify the conditions for analog signals.



When you use CH ALL to set an input, range and filter, all channels are set to the same values if the input is the same. Range is set only for the same input channels. However, the range of a channel is not changed if its EU (scaling) is set to On. Span All Settings is set only for the same range channels.

\*If CH1 has an input that is set to Off, the input of CH ALL is set to Off.

#### (1)-1 Input

Selects input condition

Selection item	Description
Off	Input signal measurement is disabled. No waveform or digital value is displayed.
Voltage	Used for measuring direct-current voltage.
Temperature	Used for measuring temperature.
Humidity	Used for measuring humidity with the humidity sensor B-530. In this case, the voltage range will become 1 V, and the EU settings will not be available.

#### (1)-2 Range

Selects the range of measurement.

Input item	Description
Voltage	20, 50, 100, 200, 500 mV; 1, 2, 5, 10, 20, 50, 1-5 V
Temperature	TC-K, TC-J, TC-T, TC-R, TC-E, TC-B, TC-S, TC-N, TC-W
Humidity	No selection available

Available SPAN Settings

<Voltage Ranges>

Range	Maximum SPAN	Minimum SPAN	Minimum Resolution
20mV	-22.000 to +22.000mV	0.200mV	0.001mV
50mV	-55.00 to +55.00mV	0.50mV	0.01mV
100mV	-110.00 to +110.00mV	1.00mV	0.01mV
200mV	-220.00 to +220.00mV	2.00mV	0.01mV
500mV	-550.0 to +550.0mV	5.0mV	0.1mV
1V	-1.1000 to +1.1000V	0.0100V	0.0001V
2V	-2.2000 to +2.2000V	0.0200V	0.0001V
5V	-5.500 to +5.500V	0.050V	0.001V
10V	-11.000 to +11.000V	0.100V	0.001V
20V	-22.000 to +22.000V	0.200V	0.001V
50V	-55.00 to +55.00V	0.50V	0.01V
1-5V	-5.500 to +5.500V	0.050V	0.001V

<Temperature Ranges>

Range	Maximum SPAN	Minimum SPAN (p-p)	Measurement Range	Minimum Resolution
K	-270 to +2000°C	50°C	-200 to +1370°C	0.1°C
J	-270 to +2000°C	50°C	-200 to +1100°C	
T	-270 to +2000°C	50°C	-200 to +400°C	
R	-270 to +2000°C	50°C	0 to +1600°C	
E	-270 to +2000°C	50°C	-200 to +800°C	
B	-270 to +2000°C	50°C	+600 to +1820°C	
S	-270 to +2000°C	50°C	0 to +1760°C	
N	-270 to +2000°C	50°C	0 to +1300°C	
W	-270 to +2000°C	50°C	0 to +2000°C	

<Humidity Range>

Range	Maximum SPAN	Minimum SPAN (p-p)	Minimum Resolution
	0 to +110%	1.0%	0.1%

(1)-3 Filter

Selection item	Description
Off	No moving average is calculated.
2	A moving average is calculated twice per sampling interval.
5	A moving average is calculated 5 times per sampling interval.
10	A moving average is calculated 10 times per sampling interval.
20	A moving average is calculated 20 times per sampling interval.
40	A moving average is calculated 40 times per sampling interval.

<Filter processing>

Filter processing performed on the GL220 is the moving average shown in the following figure.

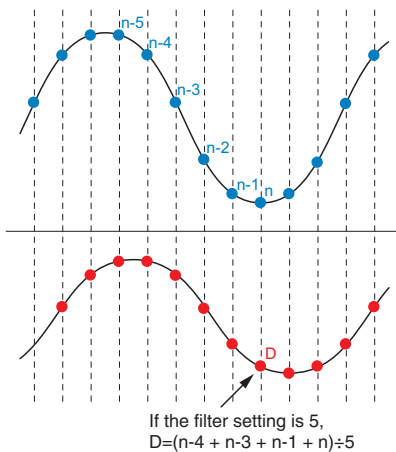

If the sample interval exceeds 5 seconds, the average value of data obtained in a sub-sample (5 seconds) is used.

(1)-4 EU (Scaling settings)

Converts the measured signals to other units.

<For voltage input>

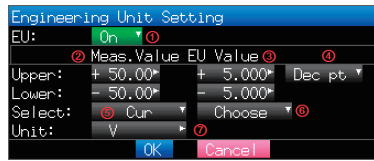

<For temperature input>

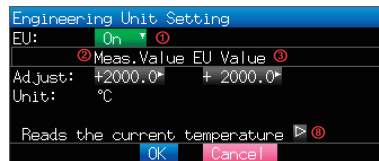

Setting	Description
(1) EU Function	Sets the scaling function to ON or OFF.
(2) Meas. Value (Upper/Lower)	Sets the upper and lower limits of values to be converted. * For temperature input, there is no distinction between upper and lower limits. * See the setting examples shown below for details.
(3) EU Output Value (Upper/Lower)	Sets the upper/lower limit output values after conversion. * For temperature input, there is no distinction between upper and lower limits. * See the setting examples shown below for details.
(4) Dec pt	Sets the decimal point position for an EU output value.
(5) Select	Selects a specific engineering unit classification. (The following are available.) Current, length, area, volume, speed, acceleration, frequency, weight, work, pressure, flow rate, temperature
(6) Choose	Selects a unit to be used after conversion. A unit displayed in this field belongs to the classification selected in "Select." To set a unit not displayed in this field, set arbitrary text in "Arbitrary unit." The setting selected in this field is displayed in "Arbitrary unit."
(7) Arbitrary Unit	Sets a unit to be used after conversion. Arbitrary text consisting of alphabetical characters and numerical values can be set as a unit. (Refer to page 3-46 for details on the text input.) When "Select" or "Choose" is used, the setting is reflected in this field.
(8) Reads the current temperature measurement value	Substitutes the current measurement value into (2) Measurement value and (3) EU output value. * The value is not substituted when burnout occurs or the scale is exceeded.

**CHECKPOINT**

- If a message window opens, follow the instruction in the message to change the setting value.
- The Scaling function performs calculation using a ratio of the Meas. Value and EU Output Value settings. The digital display shows “++++/----” when the converted value cannot be processed by the GL220.
- The span may be changed depending on the Scaling settings.
- For temperature input, the offset setting for an input value is used.

Setting example: For voltage input

	Meas. Value	EU Output Value	Dec pt	Choose
Upper limit	+5.000	+20.00	+xx.xx	rpm
Lower limit	-5.000	-20.00		

Setting example: For temperature input

Meas. Value	EU Output Value
22.0°C	25.0°C

3°C is always added to the measurement value.

(1)-5 Misc.

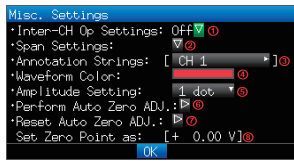

Setting	Description
(1) Inter-CH Op Settings	Sets what to do in calculation between channels. Four arithmetic operations (+, -, x, ÷) can be set as calculation between channels. * Refer to the next page for details.
(2) Span	Sets the upper and lower limits of values of a span in which a waveform should be displayed.
(3) Annotation string	Sets an annotation (comment) to be displayed for a channel. The maximum number of characters is 31. Alphanumeric characters, kana, and symbols can be input. (Refer to page 3-43 for details on the text input.)
(4) Waveform Color Setting	0 to 31 for each of red, green, blue (RGB)
(5) Amplitude Setting	1 to 8 dots
(6) Auto Zero ADJ.	Performs calculation using the current input voltage as the zero position voltage value. The range of voltages that can be automatically adjusted is ±10% of the setting range. <Example> For 1 range, the input voltage can be adjusted between -0.1 V and +1.0 V. * For temperature input, this function is not available.
(7) Reset Auto Zero ADJ.	Cancels the zero position voltage value and displays the input voltage.
(8) [Zero position voltage value]	Displays the zero position voltage value (Display only).

<Inter-CH Op Settings (1)>

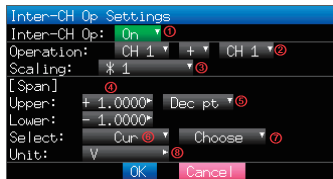

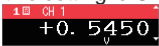
Setting	Description
(1) Inter-CH Op Settings	Off, On If this setting is ON, the channel has a calculation mark in the digital display, etc. 
(2) Operation	CH-X (Function) CH-Y CH-X CH1 to CH10 Function Four arithmetic operation functions (x, -, x, /) CH-Y CH1 to CH10
(3) Scaling	/1000000, /1000, x1, x1000, x1000000 Sets the scaling factor for a calculation result. <Example> Result = 0.001      Result = 1000 x 1: 0.001          x 1: 1000 x 1000: 1            /1000: 1 x 1000000: 1000    /1000000: 0.001
(4) Upper/Lower limits	Sets the upper and lower limits of values of a span in which a waveform should be displayed. The setting value is in reference to a calculation result.
(5) Dec pt	Sets the decimal point position for a span setting.
(6) Select	Selects a unit in which a calculation result should be displayed. Current, length, area, volume, speed, acceleration, frequency, weight, work, pressure, flow rate, temperature
(7) Choose	Selects a unit to be used after conversion. A unit displayed in this field belongs to the classification selected in "Select." To set a unit not displayed in this field, set arbitrary text in "Arbitrary unit." The setting selected in this field is displayed in "Arbitrary unit."
(8) Arbitrary Unit	Sets a unit to be used after conversion. Arbitrary text consisting of alphabetical characters and numerical values can be set as a unit. (Refer to page 3-43 for details on the text input.) When "Select" or "Choose" is used, the setting is reflected in this field.



- Calculation results are displayed in volts.  
The calculation result for 100 mV + 100 mV is 0.2.  
Use Scaling to display this result as 200 mV.

## Logic and Pulse settings

Makes settings related to digital input.

<For Pulse>



<For Logic>



### (1)-6 Logic/Pulse

Selects the processing method for digital input.

Selection item	Description
Off	Digital input measurement is disabled.
Logic	Digital input is processed as logic signals.
Pulse	Digital input is processed as pulse signals.

### (1)-7 Input

Sets the pulse measurement mode.

This setting is available only if Pulse is selected in (1)-6.

Selection item	Description
Off	Pulse input measurement is disabled.
Revol.	Counts the number of pulses per second and captures the value multiplied by 60 as rpm value.
Counts	Captures the cumulative number of pulses for each sampling interval from the start of measurement.
Inst.	Captures the number of pulses for each sampling interval.

### (1)-8 Filter

Sets the filter for input.

Selection item	Description
Off	Disables hardware filter.
On	Enables hardware filter. It is effective in a noisy environment. The filter is approximately 30 Hz (-3 dB).

### (1)-9 Pulse Slope

Sets the slope (direction) to count the number of pulses.

This setting is available only if Pulse is selected in (1)-6.

Selection item	Description
↑H	Counts the rising edges of pulses.
↓L	Counts the falling edges of pulses.

**(1)-10 EU (Scaling settings)**

Converts the measured signals to other units.

This setting is available only if Pulse is selected in (1)-7.



Setting	Description
(1) EU Setting	Sets the scaling function to ON or OFF.
(2) Meas. Value	Sets a value to be converted.
(3) EU Output Value	Sets an output value after conversion.
(4) Select	Selects a specific engineering unit classification. (The following are available.) Current, length, area, volume, speed, acceleration, frequency, weight, work, pressure, flow rate, temperature
(5) Choose	Selects a unit to be used after conversion. A unit displayed in this field belongs to the classification selected in "Select." To set a unit not displayed in this field, set arbitrary text in "Arbitrary unit." The setting selected in this field is displayed in "Arbitrary unit."
(6) Arbitrary Unit	Sets a unit to be used after conversion. Arbitrary text consisting of alphabetical characters and numerical values can be set as a unit. (Refer to page 3-43 for details on the text input.) When "Select" or "Choose" is used, the setting is reflected in this field.

**CHECKPOINT**

- If a message window opens, follow the instruction in the message to change the setting value.
- The Scaling function performs calculation using a ratio of the Meas. Value and EU Output Value settings.

The digital display shows "+++/-" when the converted value cannot be processed by the GL220.

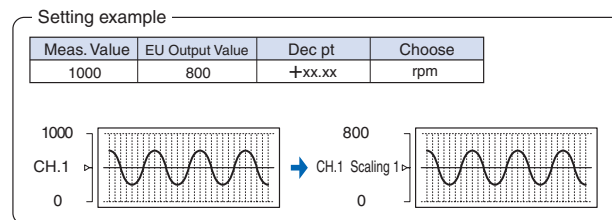

**(1)-12 Misc.**

<For Logic>



<For Pulse>

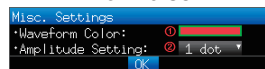

Setting	Description
(1) Waveform Color Setting	0 to 31 for each of red, green, blue (RGB)
(2) Amplitude Setting	1 to 8 dots

## (2) DATA settings

This menu is used to specify capture-related items and calculations.

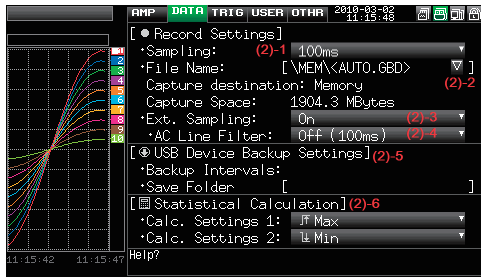

Setting	Selections available
Sampling	10, 20, 50, 100, 125, 200, 250, 500 ms; 1, 2, 5, 10, 20, 30s; 1, 2, 5, 10, 20, 30 min; 1h * Available sampling intervals vary depending on the input settings and the number of channels to be used. * Refer to "(2)-1 Sampling Interval" for details.
Capture destination	Internal memory, USB memory
File Name	* See the description of a captured data file name given below.
External Sampling	Off, On
AC Line Filter	Off, On
Backup	Backup interval : Off, 1, 2, 6, 12, 24 hours
	Save folder : Folder name
Calc. Settings 1	Off, Average, Max, Min, Peak, RMS
Calc. Settings 2	Off, Average, Max, Min, Peak, RMS

### Captured data file name

Setting	Selections available
Folder (File)	Capture destination : MEM, USB1 Folder : Text input (if the naming method is Auto) File : Text input (if the naming method is Arbitrary or Sequential number)
Name Type	Auto, Arbitrary, Sequential number
File Type	Binary (GBD), Text (CSV)

### (2)-1 Sampling interval

Sets the sampling interval for data capture.

The table below shows the number of measuring channels and sampling interval values that can be set. If data fluctuate due to noise, set the sampling interval to a value which enables the digital filter function.

Number of Measuring Channels*1	Allowed Sampling Interval	Sampling Interval which enables Digital Filter
1 CH	10 ms or slower *2	50 ms or slower
2 CH	20 ms or slower *2	125 ms or slower
3 CH to 5 CH	50 ms or slower *2	250 ms or slower
6 CH to 10 CH	100 ms or slower	500 ms or slower

\*1: "Number of Measuring Channels" is the number of channels in which input settings are NOT set to "OFF".

\*2: The temperature setting is not available for sampling intervals of 10, 20, and 50 ms



To use the digital filter function, you must set the AC power supply frequency accurately. Follow the instructions on page 3-35 to ensure that the settings are accurate.

(2)-2 Captured data file name

Select the name of a file or folder to which you want to save capture data.

<If the naming method is Auto>

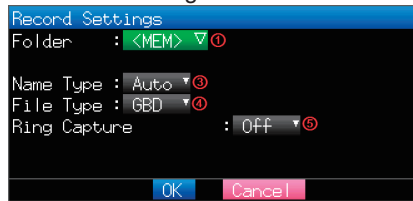

<If the naming method is Arbitrary>

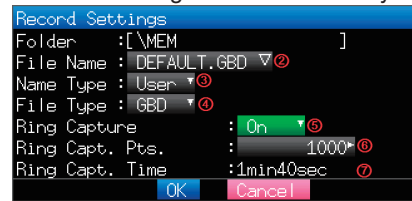

Setting	Description
(1) Folder	Specify a folder to which you want to capture (or save) data. Refer to page 3-41, "File box" for details.
(2) File	Specify a file to which you want to capture (or save) data. Refer to page 3-41, "File box" for details.
(3) Name Type	<p>Set how a data file should be named.</p> <p>Auto : Automatically supplies the file name.                      Example: 20050101-123456_UG.GBD                      Number part : File creation date                      * The file is created on January 1, 2005, 12:34:56 in this example.</p> <p>UG : User number of the user capturing data                      UG: Guest                      U1: User 1                      U2: User 2</p> <p>GBD : Data format GBD (Binary data)                      CSV (Text format)</p> <p>Arbitrary : Data is captured to a file with an entered file name.                      Sequential number : A file is created with an arbitrary file name that has been entered, followed by a sequential number.                      Example: If the file name is "TEST"                      First time : TEST_SER1.GBD                      Second time : TEST_SER2.GBD                      Third time : TEST_SER3.GBD</p> <p>* If the same file name already exists, _CP* is added to the end of a file name to prevent overwriting. The asterisk (*) represents a number.                      Example: TEST_CP1.GBD</p>
(4) File Type	<p>Sets the file format used to save data.</p> <p>GBD : Creating a data file in Graphtec's proprietary binary format                      * Data tampering can be prevented.</p> <p>CSV : Creating a data file in text format                      * Replaying on the GL220 is not available.</p>
(5) Ring Capture	Sets the ring capture function to On or Off.
(6) Number of Ring Capture Points	Specifies the number of data points in one file when the ring capture function is On (See the following figure for details).
(7) Ring Capture Time	Displays the possible measurement time with one file when the ring capture function is On.



● Ring Capture Function

Ring-captur has been operating in this instrument is as follows.

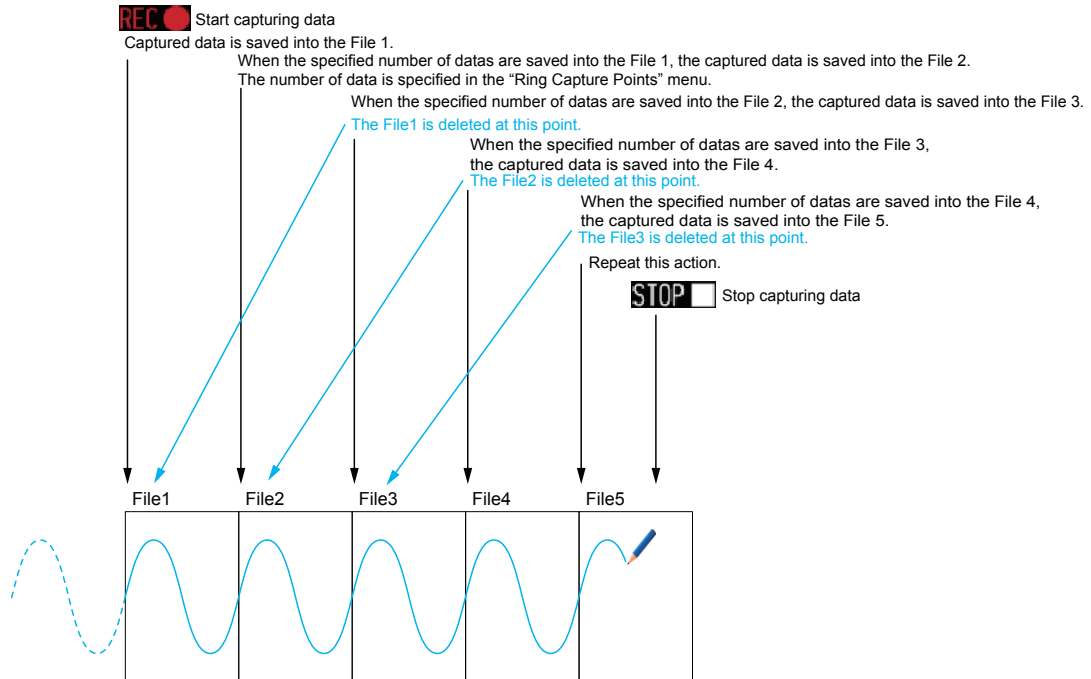

When capturing is stopped at the STOP point in the above, the File4 and the File 5 are remained. These files are consolidated into one file and it is saved. Then the ring catpuer is completed.

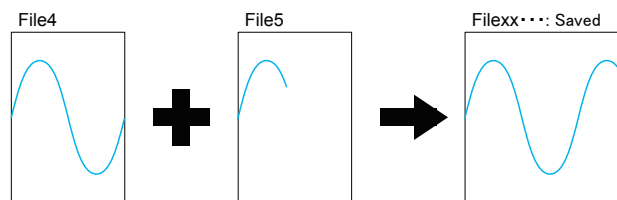

Twice as many files as the Number of Ring Capture Points will be created at the maximum.



When you save files, create a folder and then save the files in the folder. Regardless of the remaining capacity, if you try to save files in the root directory, you may not be able to save files due to file system restrictions.



Changing the sampling interval, capture destination, number of measuring channels (number of channels for which the input is not Off), etc. will change the Free Space and Capture Time on the screen. If you find that the measurement time exceeds the Capture Time, take one of the following measures:

- Change the sampling interval.
- Copy the files on the internal memory to your PC and delete them.
- Change the capture destination to USB memory with larger free space.



Free Space : Displays the amount of memory space available for capture at the capture destination.

Capture Time : Displays time available for capture.

\* The Capture Time is calculated for 2 GB at the maximum.

The Capture Time more than 366 days is displayed as More Than 366 days.

(2)-3 External sampling

Enables or disables external sampling.

When the external sampling function is enabled, data is captured at the shortest intervals and retained temporarily.

This retained data is updated at the shortest intervals.

When an external sampling pulse is received, the retained data is written to the memory.

(See the following figure.)

Therefore, the maximum error in time between the actually captured data and the external sampling pulse is the same as the shortest interval.

\* Refer to the next section, "(2)-4 AC line filter" for details on the shortest interval.

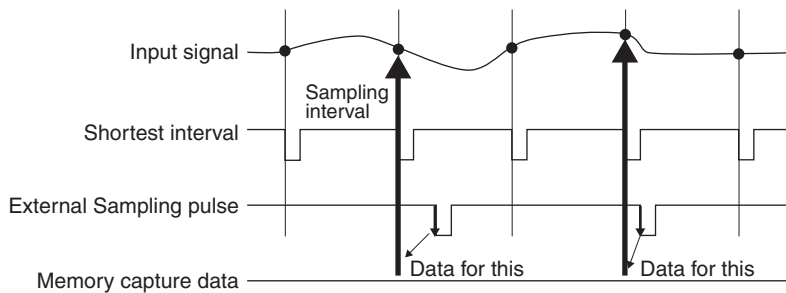

**CHECKPOINT**

- If the external sampling function is ON, the external input cannot be selected for the trigger setting. If the external input has already been set, the trigger will be set to Off.
- When you measure signals with high noise levels, set the AC line filter described in the next section to ON.

(2)-4 AC line filter

Enables or disables the AC line filter while external sampling is enabled.

Enable this setting to enable the digital filter. - When you use external sampling and measure signals with high noise levels, set the AC line filter to ON.

The shortest interval is displayed under the settings.



The shortest interval is as shown in the following table:

Number of Measuring Channels *1	Shortest interval	
	Digital filter OFF	Digital filter ON
1 CH	10ms	200ms
2 CH	20ms	500ms
3 to 5 CH	50ms	1s
6 to 10 CH	100ms	1s

\*1 The Number of Measuring Channels is the number of channels for which the input setting is not OFF.

### (2)-5 Backup setting

The GL220 has a function that periodically backs up captured data (See the figure below). This section explains how to set the data backup conditions.

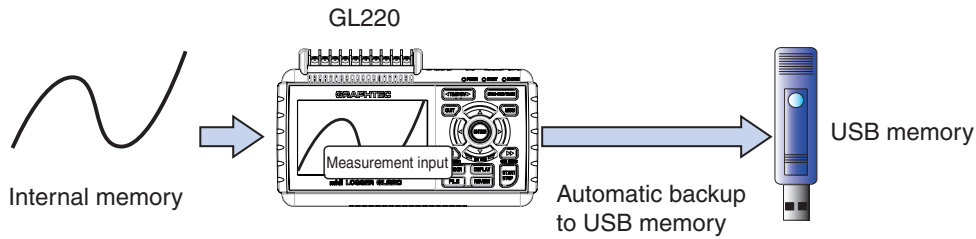

Setting	Description
Backup interval	Sets the backup interval for captured data. Off, 1, 2, 6, 12, 24 hours
Save folder	Sets the folder for saving a backup file. * This must be a folder on USB memory or an FTP server. Example: \GRAPHTEC\20091205



\* If ring capture is On, the backup function is not available.

### (2)-6 Statistical calculation setting

Two types of operation can be performed on all channels.

This section explains setting what to do in statistical calculation.

Setting	Description
Off	Calculation is not performed.
Average	Displays the simple average value of the data during data capture.
Max	Displays the maximum value of the data during data capture.
Min	Displays the minimum value of the data during data capture.
Peak	Displays the peak value of the data during data capture.
RMS	Displays the RMS value of the data during data capture. The calculation formula is as follows: $R.M.S = \sqrt{\sum D^2/n}$ D: data n: number of data



- Calculation results are displayed in the Digital + Statistical Calculation Display screen. Use the <<<>>> keys to set All Mode. Refer to page 3-9 for details on All Mode.
- At power-on, calculation is started; The result is cleared when you press the QUIT key or the Start key to start measurement.

**(3) TRIG settings**

This menu is used to specify trigger conditions and alarms.



Setting	Selections available
Start Side Source Setting	Off, Level, Alarm, External Input, Time, Day, Duration
[Level]	Mode Analog: Off, ↑H, ↓L, Window In, Window Out Logic: Off, ↑H, ↓L Pulse: Off, ↑H, ↓L, Window In, Window Out
	Combination Level OR, Level AND, Edge OR, Edge AND
	Level Set numeric value
[Alarm]	Alarm port number 1•2•3•4
[Date]	Date From 2005.1.1 to 2035.12.31
	Time From 0:0:0 to 23:59:59
[Weekly]	Day of week Off or On setting for each of Sunday through Saturday
	Time From 0:0:0 to 23:59:59
[Time]	From 0:0:1 to 9999:59:59
Stop Side Source Setting	Off, Level, Alarm, External Input, Time, Day, Duration
[Level]	Mode Analog: Off, ↑H, ↓L, Window In, Window Out Logic: Off, ↑H, ↓L Pulse: Off, ↑H, ↓L, Window In, Window Out
	Combination Level OR, Level AND, Edge OR, Edge AND
	Level Set numeric value
[Alarm]	Alarm port number 1•2•3•4
[Date]	Date From 2005.1.1 to 2035.12.31
	Time From 0:0:0 to 23:59:59
[Weekly]	Day of week Off or On setting for each of Sunday through Saturday
	Time From 0:0:0 to 23:59:59
[Time]	From 0:0:1 to 9999:59:59
Repeated Capturing	Off, On
Alarm Level Settings	Mode Analog: Off, ↑H, ↓L, Window In, Window Out Logic: Off, ↑H, ↓L Pulse: Off, ↑H, ↓L, Window In, Window Out
	Level Set numeric value
	Output 1•2•3•4
	Detection Method Level, Edge
	Alarm Hold On, Off
	Send Burnout Alarm On, Off

**(3)-1 Start side source setting**

Specifies trigger conditions to start data capture.

Selection item	Description
Off	Starts capturing data unconditionally when you press the Start/Stop key.
Level	Starts capturing data when a specified level is reached. -> When Level is selected, the condition for each channel must be set. Refer to page 3-31 for details.
Alarm	Starts capturing data when an alarm is generated in the specified alarm port.
External Input	Starts capturing data when an input signal is received from an external trigger terminal. * A trigger is established at a transition from 5 V (open) to 0 V (shorted to the ground). A falling edge operation occurs.
Date	Starts capturing data when specified date and time arrives.
Weekly	Starts capturing data at the specified time on days of week for which On is set. Example: On is set for Mon, Tue, Wed, Thu, and Fri, Off is set for Sun and Sat, and 9:00 is set as the time. Starts capturing data at 9:00 on weekdays. Does not start capturing data on Sat and Sun.
Time	Starts capturing data when a specified length of time elapses.

### (3)-2 Stop side source setting

Specifies trigger conditions to stop data capture.

Selection item	Description
Off	Stops capturing data unconditionally when you press the Start/Stop key.
Level	Stops capturing data when a specified level is reached. -> When Level is selected, the condition for each channel must be set. Refer to page 3-30 for details.
Alarm	Stops capturing data when an alarm is generated in the specified alarm port.
External Input	Stops capturing data when an input signal is received from an external trigger terminal. * A trigger is established at a transition from 5 V (open) to 0 V (shorted to the ground). A falling edge operation occurs.
Date	Stops capturing data when specified date and time arrives.
Weekly	Stops capturing data at the specified time on days of week for which On is set. Example: On is set for Mon, Tue, Wed, Thu, and Fri, Off is set for Sun and Sat, and 17:00 is set as the time. Starts capturing data at 17:00 on weekdays.
Time	Stops capturing data when a specified length of time elapses.

#### CHECKPOINT

- When External Input is used as the trigger source, no stop trigger is accepted for 50 ms after capture is started.
- When the start trigger is External Input, data is captured at sampling intervals (fixed to 5 seconds if they are more than 5 seconds) and retained temporarily.  
This retained data is refreshed at sampling intervals (fixed to 5 seconds if they are more than 5 seconds).  
Since the external trigger input operation conducts detection at 10 ms intervals asynchronously from sampling, the retained data becomes the first point when an external trigger is detected. Starting from this point, data is captured at sampling intervals.
- If the stop trigger is also an external trigger, detection is conducted at 10 ms intervals, and data capture stops as soon as the stop trigger is detected.

### (3)-3 Repeated capturing

Sets up the repeat function to conduct repeated capturing.

Selection item	Description
Off	The repeat function is disabled.
On	The repeat function is enabled. After one capture is ended, the next capture is started (If the start side source setting is not Off, the GL220 waits for a trigger).

### (3)-4 Alarm level settings

Sets alarm generation conditions, output destination, etc.

When the conditions specified here are met, the alarm output terminal (for which an output destination number must be specified for each channel) outputs an alarm.

Refer to page 3-30 for details on the condition setting for each channel.

### (3)-5 Alarm hold

When "On" is selected here and once the conditions are met, an alarm is not canceled even if the conditions are no longer met later (Press the CURSOR key to cancel it).

### (3)-6 Send burnout alarm

When "On" is selected here, the generation of a burnout (refer to page 3-35) causes the alarm output terminal to output an alarm.

**Trigger level settings/Alarm level settings**

Specifies detailed conditions for each channel when the start and stop side source settings are Level. The configuration of the level trigger is as shown in the figure below.

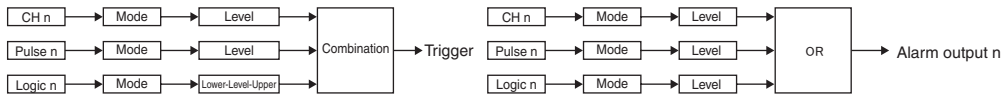

\* Pulse and Logic are switchable.

\* Pulse and Logic are switchable.

\* Specify an alarm output destination for each channel and Pulse/Logic. Each of the alarms is ORed at the output destination.

Example: If you specify 1 as the output destination of 1CH and 2CH and 2 as that of 3CH and 4CH, Alarm Output 1 occurs when one of 1CH and 2CH meets the conditions, and Alarm Output 2 occurs when one of 3CH and 4CH meets the conditions.

<Trigger level settings>



Place the cursor here and press the ENTER key to open the following setting screen.

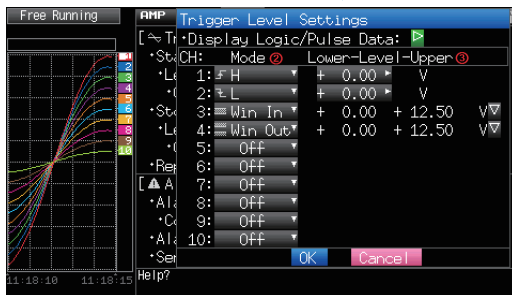

<Alarm level settings>



Place the cursor here and press the ENTER key to open the following setting screen.



Setting	Description
(1) Combination <For Trigger>	Sets a combination of trigger conditions set for each channel. Level OR : Starts (stops) capturing data when at least one of the specified trigger conditions is met. Each condition is Level operation. Level AND : Starts (stops) capturing data when all of the specified trigger conditions are met. Each condition is Level operation. Edge OR : Starts (stops) capturing data when at least one of the specified trigger conditions is met. Each condition is Edge operation. Edge AND : Starts (stops) capturing data when all of the specified trigger conditions are met. Each condition is Edge operation.
Detection method <For Alarm>	Level: Each condition is Level operation. Edge: Each condition is Edge operation.
(2) Mode	Sets a trigger comparison mode for each channel. Off : Disables triggers for the setting channel. ↑H (rising) : A trigger is generated when the input signal exceeds the specified level. ↓L (falling) : A trigger is generated when the input signal falls below the specified level. Win In : Used to specify the upper and lower limits for each channel. When the input signal level is (or comes) between these limits, a trigger is generated. * This setting is not available for Logic CH. Win Out: Used to specify the upper and lower limits for each channel. When the input signal level is (or goes) out of these limits, a trigger is generated. * This setting is not available for Logic CH.
(3) Level	Sets a trigger comparison level. If the mode is ↑H (rising) or ↓L (falling), set one comparison level. If the mode is Win In or Win Out, set two comparison levels.

### Level and Edge operations

In the Level operation, a trigger is assumed to be generated if the trigger conditions are met when the START key is pressed.

In the Edge operation, a trigger is not assumed to be generated even if the trigger conditions are met when the START key is pressed.

A trigger is assumed to be generated when the trigger conditions, after not being met, are met again.

\* A trigger is still assumed to be generated even if the trigger conditions are met once in the Edge operation and then are no longer met.

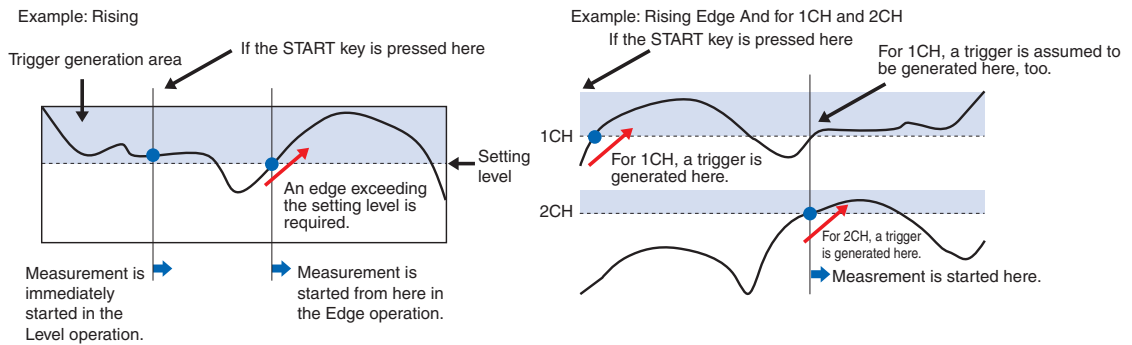

### Trigger and Alarm operations

**Rising** : A trigger/alarm is generated when the input signal is higher than the specified level.

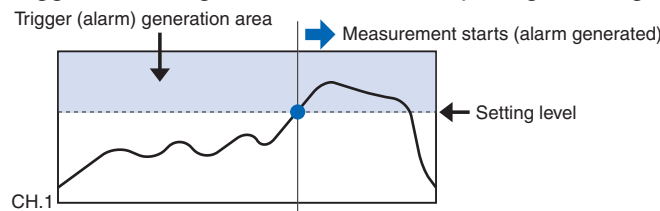

**Falling** : A trigger/alarm is generated when the input signal is lower than the specified level.

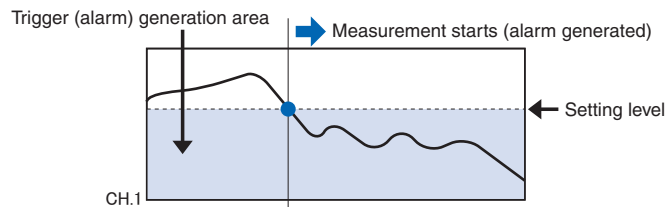

**Win In** : Used to specify the upper and lower limits for each channel. When the input signal level comes (or is) between these limits, a trigger/alarm is generated.

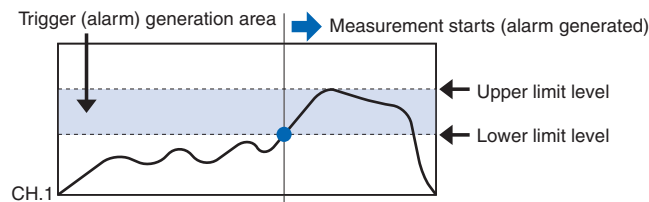

**Win Out** : Used to specify the upper and lower limits for each channel. When the input signal level goes (or is) out of these limits, a trigger/alarm is generated.

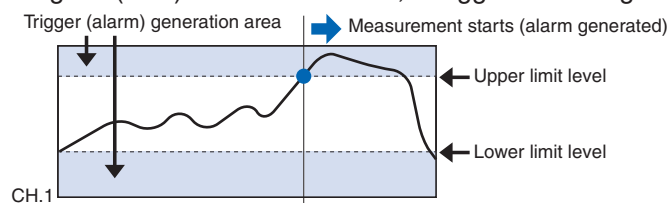

### Dead zones of trigger and alarm levels

Trigger and alarm levels are provided with a dead zone in order to prevent false detection due to noise.

Since a dead zone exists as shown in the figure below, the conditions are met at different points between rising and falling signals.

Therefore, errors in relation to the setting levels are generated as shown in the figure below.

<For Temperatures>

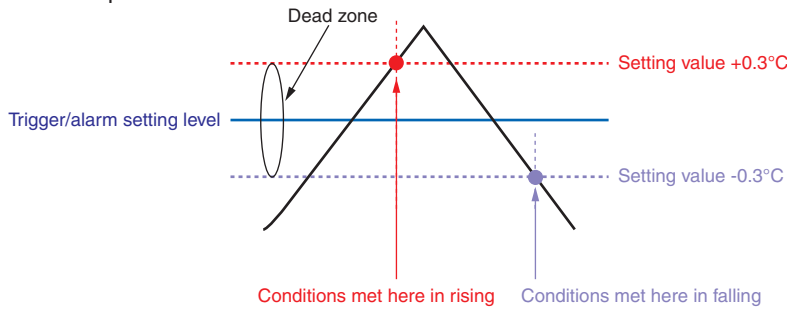

An alarm that has occurred is canceled at the following levels:

- For rising setting: Setting value -0.4°C
- For falling setting: Setting value +0.4°C

<For Voltages>

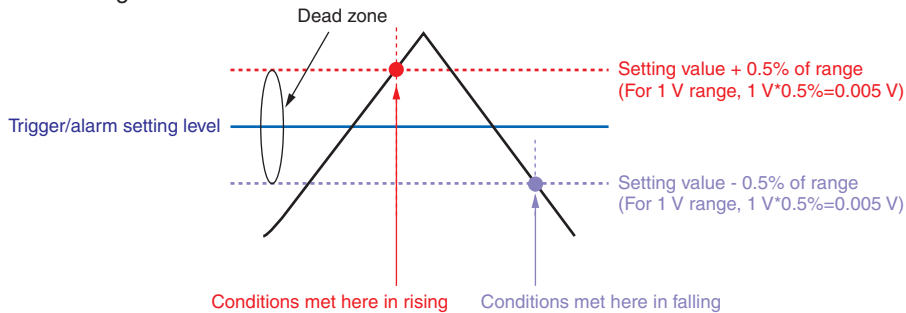

### (4) USER settings

By switching between users using the USER Setting, you can easily read out different setting conditions that have been stored



Selection item	Selections available	
User	Text input (when User is selected)	
Department name	Text input (when User is selected)	
Setting conditions switch	Guest, User 1, User 2)	
Macro file name	Folder	MEM, USB1
	File Name	Specify a file name.
Macro run	▷ Press right key to execute.	



(4)-1 USER settings

Setting	Description
User	Specify the user name. You cannot specify it as Guest.
Department name	Specify the department name. You cannot specify it as Guest.
Setting conditions switch	Switches between Guest, User1 and User2. Since setting conditions are stored for each user, they can be called up easily by simply switching the user.

(4)-2 About the Macro

Interface commands for GL220 can be described in a text file and read in. GL220 will operate as described in this file.

<Macro operation flow>



Create a macro file using a text editor on your PC (save the file with extension "GMA").

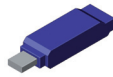

Copy this file to a USB memory, and then connect the USB memory to GL220.

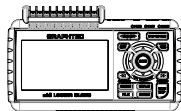

Select the macro file and run the file.

- Macro file name:
- Execute Macro:

GL220 executes the commands as described in the macro file.



Macro description example (file name: xxx.GMA)

```

GL220MACRO.GMA - Notepad
File Edit Format View Help

// ***** GL220 Macro File *****
// Input Setting
:AMP:CH1:INP TEMP:RANG TCT // CH1 Temperature
:AMP:CH2:INP DC:RANG 500mV // CH2 DC 500mV
:AMP:CH3:INP RH // CH3 Humidity

// Span Setting
:SPAN:CH1:SET 100,0,"c" // CH1 0-100C

// Annotation Setting
:ANN:CH1 "Batt. Temp" // CH1 Annotation

// Sampling Setting
:DATA:SAMP 1s // Sampling 1sec
    
```

**CAUTION**

Refer to the "Interface Command Table" for details on commands supported by GL220 on a separatesheet. The "Interface Command Table" is included in the CD. (Library folder GL220\_820\_IF\_Command.PDF) Supported commands are limited to those relative to GL220 settings. Read in commands cannot be used.

**(5) OTHR settings**

Other miscellaneous settings are made here.



Setting		Selections available
LCD brightness		Light, Medium, Dark
Screen Saver		Off, 10, 30 (sec.), 1, 2, 5, 10, 30, 60 (min.)
Power On Start		Disable, Enable
Background Color		Black, White
AC Line Frequency		50/60Hz (Off, On)
USB ID		0 to 9
Temperature setting	Room Temp.	Internal, External
	Temp. Unit	°C, °F
	Burn Out	Off, On
Date/Time	Date/Time	Date
		Time
Language		Japanese, English (US), English (UK), French, German, Chinese, Korean
Return to default settings		▷ Press right key to execute.
Information		▽ Down button to display information
Demo Waveform Mode		Off, On
Game		Several games

**(5)-1 LCD brightness**

Sets the brightness of the LCD backlight.

**(5)-2 Screen Saver**

Automatically turns off the display if the GL220 is not operated within a specified interval.

Turns off the display if not operated for some time to extend the service life of the LCD screen.

If the GL220 runs on a battery pack (B-517, option), the use of this function prolongs the drive time.

**(5)-3 Power On Start**

Sets the feature which initiates measurement as soon as the GL220 is turned on.

Selection item	Description
Disable	Disables the Power On Start function.
Enable	Enables the Power On Start function.

#### (5)-4 Background Color

Sets the background colors of the waveform display area and the digital display area.

#### (5)-5 AC Line Frequency

Select the frequency of the AC line used.

Selection item	Description
50Hz	For an area with a power supply frequency of 50 Hz
60Hz	For an area with a power supply frequency of 60Hz

#### CAUTION

In this setting, select a frequency for noise removal using the digital filter. Note that no noise in the power supply can be removed if this setting is wrong. The digital filter is enabled at sampling intervals of 500 ms and above.

#### (5)-6 USB ID

Sets the USB ID number of the GL220.

Specify a number from 0 to 9.

To control more than one GL220 unit with one PC, assign a unique USB ID to each of them.

#### (5)-7 Temperature setting



Selection item	Remarks
(1) Room Temp. Compensation	This parameter enables room temperature compensation settings when thermocouples are used. Internal : The GL220's room temperature compensation settings are used (usually, you use this parameter.) External : Select this parameter when measuring compensation other than that of the GL220.
(2) Temp. Unit	Toggles the temperature unit between °C (Centigrade) and °F (Fahrenheit) for temperature settings. When °F (Fahrenheit) is selected, calculation is performed using the following formula: °F (Fahrenheit) = °C (Centigrade) x 1.8 + 32 Calculate the accuracy as: Centigrade accuracy x 1.8.
(3) Burn Out	This parameter enables or disables a function that conducts burnout check on a thermocouple. On: Periodical burnout check is conducted. Off: Burnout check is disabled. <b> CAUTION</b> During a burnout check, voltage is applied to the GL220. Therefore, set Burn Out to Off when the GL220 is connected in parallel with other devices to avoid any effect from these voltages.

#### (5)-8 Date/Time

Makes settings related to the GL220 clock.

#### (5)-9 Language

This parameter sets the GL220's display language.

(5)-10 Return to default settings

Returns all the settings to the factory defaults.

(5)-11 Information

Displays system information.

(5)-12 Demo Waveform Mode

This parameter displays demo waveforms without analog signal input.

Selection item	Description
Off	The demo waveform is not displayed.
On	The demo waveform is displayed.

(5)-13 Game

Several games are available. The score is stored for each user.

## (6) FILE menu

Performs file-related operations.

The items to be displayed vary depending on the operation mode. Refer to page 3-13 for details on the operation modes.

<Free Running Status>

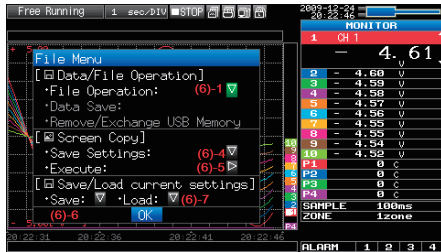

<Replay or Double-Screen Replay Status>

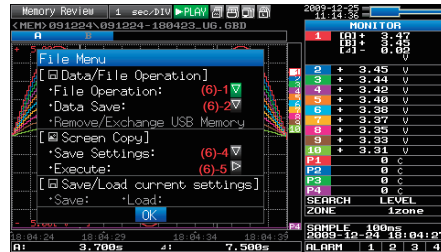

<Capture Status>

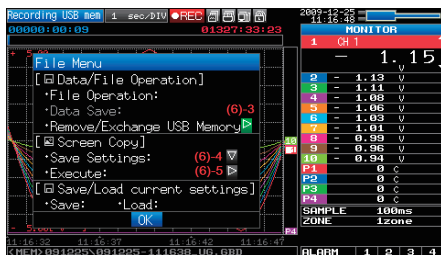

### (6)-1 File Operation

Operate files in the main memory and USB device. For details on file operation, see on page 3-41.

### (6)-2 Data Save

Saves data being replayed to the internal memory or USB memory.

<If the naming method is Auto>



<If the naming method is Arbitrary>



Setting	Description
(1) Folder	Specify a folder to which you want to save data. Refer to page 3-41, "File box" for details.
(2) File	Specify a file to which you want to save data. Refer to page 3-41, "File box" for details.
(3) File Type	Sets the file format used to save data. GBD: Creating a data file in Graphtec's proprietary binary format * Data tampering can be prevented. CSV: Creating a data file in text format * Replaying on the GL220 is not available.
(4) Name Type	Set how a data file should be named. Auto : Automatically supplies the file name. Example: 20050101-123456_UG.GBD Number part : File creation date * The file is created on January 1, 2005, 12:34:56 in this example. UG : User number of the user capturing data UG: Guest U1: User 1 U2: User 2 GBD : Data format GBD (Binary data) CSV (Text format) Arbitrary : Data is captured to a file with an entered file name. Sequential number : A file is created with an arbitrary file name that has been entered, followed by a sequential number.
(5) Save Range	Sets the range of data to be saved. All Data : Saves all data regardless of the cursors. Data between Cursors : Saves only a range of data between cursors A and B.

**(6)-3 Remove/Exchange USB Memory**

The GL220 allows you to exchange the USB memory while data is captured to it. Exchange the USB memory in accordance with the following procedure:

- (1) Press the FILE key to open the FILE menu.

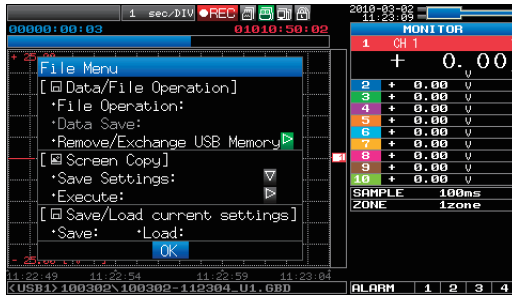

- (2) Move the cursor to Remove/Exchange USB Memory and press the ENTER key.

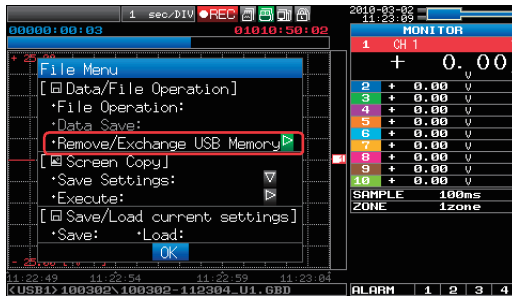

- (3) You can remove the USB memory device when the message is displayed.

USB memory can be removed/exchanged.

During measurement, make sure that the replacement needs to be completed within 5 min.

Press ENTER key after removal/exchange.

[ENTER]Apply

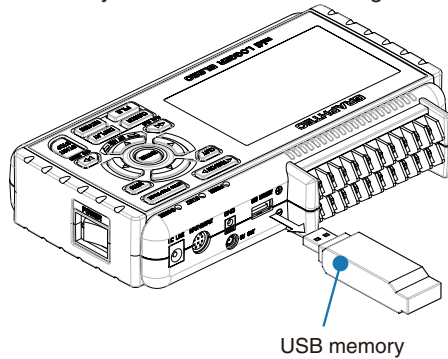

**CAUTION**

Do not remove the USB memory device before the message is displayed. Data may become corrupt and inaccessible.

- (4) Insert a new USB memory device.

USB memory can be removed/exchanged.

During measurement, make sure that the replacement needs to be completed within 5 min.

Press ENTER key after removal/exchange.

[ENTER]Apply

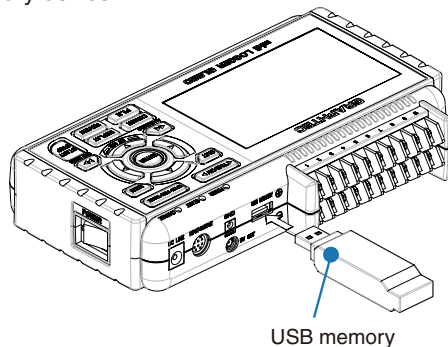

- (5) After checking that the USB memory access display turns green, press the ENTER key.  
 Refer to page 3-3 for details on USB memory access.



“\_CHG” and a number will be appended to the file name each time you exchange a USB memory device.

Example: When data is captured to the file “TEST.GBD”:

- First USB memory device : TEST.GBD
- Second USB memory device : TEST\_CHG1.GBD
- Third USB memory device : TEST\_CHG2.GBD

\* While ring capture is On, the USB memory device cannot be exchanged.



The exchange procedure must be completed within five minutes. Data will be lost after five minutes have elapsed.

**(6)-4 Specify Save Destination (Screen Copy)**

Saves data being replayed as an image file to the internal memory or USB memory.

<If the naming method is Auto>

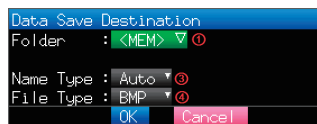

<If the naming method is Arbitrary>

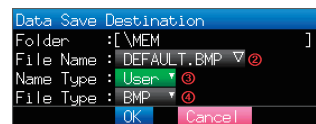

Setting	Description
(1) Folder	Specify a folder to which you want to save data. Refer to page 3-41, "File box" for details.
(2) File	Specify a file to which you want to save data. Refer to page 3-41, "File box" for details.
(3) Name Type	Set how a data file should be named. Auto : Automatically supplies the file name. Example: 20050101-123456_UG.BMP Number part : File creation date * The file is created on January 1, 2005, 12:34:56 in this example. UG : User number of the user capturing data UG: Guest U1: User 1 U2: User 2 BMP : Data format BMP: Bitmap file format PNG: Ping format Arbitrary : Data is captured to a file with an entered file name. Sequential number : A file is created with an arbitrary file name that has been entered, followed by a sequential number.
(4) File Type	Sets the file format used to save data. BMP: Saves data in bitmap file format PNG: Saves data in ping format

**(6)-5 Execute (Screen Copy)**

Executes screen copy and saves it to an image file. \* Refer to page (6)-4 "Specify Save Destination" for details on specifying the save destination.

**(6)-6 Save**

Saves the setting conditions of the GL220.

<If the naming method is Auto>

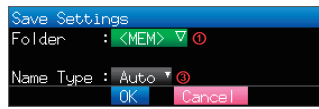

<If the naming method is Arbitrary>

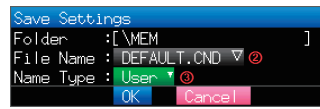

Setting	Description
(1) Folder	Specify a folder to which you want to save data. Refer to page 3-41, "File box" for details.
(2) File	Specify a file to which you want to save data. Refer to page 3-41, "File box" for details.
(3) Name Type	Set how a data file should be named. Auto : Automatically supplies the file name. Example: 20050101-123456_UG.CND Number part : File creation date * The file is created on January 1, 2005, 12:34:56 in this example. UG : User number of the user capturing data UG: Guest U1: User 1 U2: User 2 CND : Data format (GL220 setting file format) Arbitrary : Data is captured to a file with an entered file name. Sequential number : A file is created with an arbitrary file name that has been entered, followed by a sequential number.

**(6)-7 Load**

Loads and reflects the GL220 setting conditions from a file.

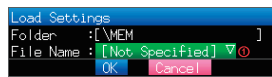

Setting	Description
(1) File	Specify a file to which you want to save data. Refer to page 3-41, "File box" for details.



**(7) File box**

The file box used to set captured data files using the DATA menu or for disk operations accessed using the FILE menu is operated as follows.

<File box by disk operations>



Key	Description
	Change the operation of the file box.
	Show properties ..... Display details of a file or folder. Select file/folder ..... Select files or folders to write data. Create new folder ..... Create a new folder. Create new file ..... Create a new file. Rename ..... Change the file or folder name. Copy file/folder ..... Copy files or folders. Select file to copy/delete ..... Select the file to copy or delete. Select copy destination and copy ... Select the copy destination and copy. Delete file/folder ..... Delete files or folders. Change file sort order ..... Change the order in which files are displayed. View setting ..... Change displaying information for files. Format disk ..... Format the disk. * Details of allowed operation will depend on the operation target.
< >	Moves between folders. < : Move up one folder. > : Move down one folder.
ENTER	Finalize the operation.
QUIT	Close the file box.

<Setting example>

The following shows an operation example where a folder named "TEST" is created for captured data and automatically saved.



In the [Data save Destination], choose [Select folder] and press the ENTER key.



Use the ▷ key to move to the target folder.



Use the ▷▷ key to select [Create new folder].  
Press the ENTER key.  
When the input box for a new folder name opens, enter "TEST" and click OK.



Use the << key to choose [Select file/folder].

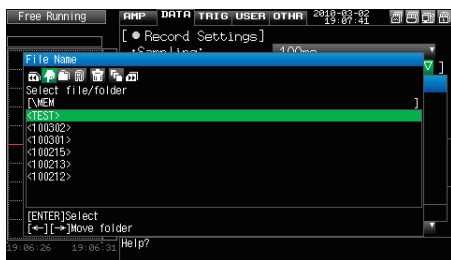

Use the ∇Δ key to move the cursor to the created "TEST" folder, and press the ENTER key.



Select [OK] to close the screen.

**(8) Text input**

Related to text input operations such as annotation, EU (scaling) unit and captured data file name input.



## • Operation

Operation mode	Description	Operation method	
Text input	A	Upper case alphabet mode	When the cursor key is moved to the uppermost part, operation can be selected using the left/right key. After selecting an operation, use the down key to move the cursor to the desired character.
	a	Lower case alphabet mode	
	0	Numeric mode	
	+	Symbol mode	
	←	Delete mode	
	↓	Insert mode	
	OK	Finalize mode	
When selecting operation	Text used for each operation	When you bring the cursor to a character and press ENTER, the character is entered. After you finish entering characters, move the cursor to OK and then press ENTER.	

**(9) Data replay menu**

Data replay menus are displayed by pressing the MENU key during replay.

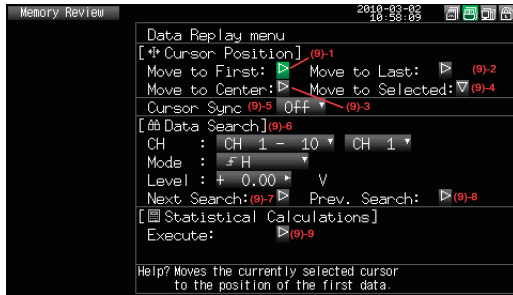

Setting		Selections available											
Cursor Position	Move to First Data	▷ Press right key to execute.											
	Move to Last Data	▷ Press right key to execute.											
	Move to Center	▷ Press right key to execute.											
	Move to Selected Position	Position, Time 0 to end of data For example, if the sampling interval is 100 ms, capture destination is the internal memory, and the number of data points is 10000, settings up to 99.9 s are available.											
		<table border="1"> <tr> <td>Method:</td> <td>Position</td> <td>Date from the start to end of the data</td> </tr> <tr> <td>[Position]</td> <td>Position</td> <td>Time from the start to end of the data</td> </tr> <tr> <td>[Time]</td> <td>Date</td> <td></td> </tr> <tr> <td></td> <td>Time</td> <td></td> </tr> </table>	Method:	Position	Date from the start to end of the data	[Position]	Position	Time from the start to end of the data	[Time]	Date			Time
Method:	Position	Date from the start to end of the data											
[Position]	Position	Time from the start to end of the data											
[Time]	Date												
	Time												
	Cursor Synch	Off, On											
Data search	CH	CH1 to 10, Logic, Pulse, Alarm * Logic and Pulse are displayed only if the Logic Pulse function is On in the AMP settings.											
		[CH1 to CH10]	CH1-10										
		[Logic]	Logic1-4										
		[Pulse]	Pulse1-4										
		[Alarm]	Alarm1-4										
	Mode	[CH1 to CH10]	↑H, ↓L										
		[Logic]	↑H, ↓L										
		[Pulse]	↑H, ↓L										
		[Alarm]	Both, ↑H, ↓L										
	Level	[CH1 to CH10]	Set numeric value Set numeric value										
	Find Next	▷ Press right key to execute.											
	Find Previous	▷ Press right key to execute.											
Statistical calculation between cursors	Function	Off, Average, Max, Min, Peak, RMS											
	Execute	▷ Press right key to execute.											

(9)-1 Move to First Data

Executing this option moves the currently selected cursor (A or B) to the start of the data.

(9)-2 Move to Last Data

Executing this option moves the currently selected cursor (A or B) to the end of the data.

(9)-3 Move to Center

Executing this option moves the currently selected cursor (A or B) to the center of the data.

### (9)-4 Move to Selected Position

Sets a position (relative position in time) or time and moves the currently selected cursor (A or B) to this position or time.

<If the Method is Position>

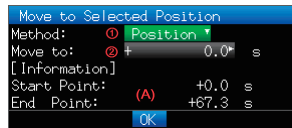

<If the Method is Time>

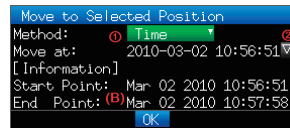

Setting	Selections available
(1) Method	Sets the method for specifying the position to move the cursor to. Select Position or Time.
(2) Position	Sets the position to move the cursor to. Specify how far down you want to move the cursor from the capture start position assumed as 0. Only positions down to the end of the data can be set. Check the setting range in the (A) part.
(3) Time	Sets the position to move the cursor to using a date and time. Only positions from the start to the end of the data can be set. Check the setting range in the (B) part.

### (9)-5 Cursor Sync

Sets up the function that moves two cursors in synchronization.

Selection item	Description
Off	Cursors are not synchronized. Only the specified one cursor moves.
On	Two cursors move in synchronization. Cursor A is always the fulcrum.

\* Cursor Synch is turned Off when you move a cursor using Move to Selected Position or perform Data Search.

### (9)-6 Date Search

Sets the search conditions to be used in the next sections ((9)-7 "Find Next" and (9)-8 "Find Previous"). The operation is Edge operation.

Selection item	Description
CH	Sets the channel to be used for search. CH1-10 : The specified analog channel is used for search. Logic1-4 : The specified logic channel is used for search. Pulse1-4 : The specified pulse channel is used for search. Alarm1-4 : The specified alarm output is used for search.
Mode	Sets the search mode. Both : Detects an edge at which alarm output changes from generation to cancellation or vice versa when Alarm is selected. ↑H : Detects a rising edge of an analog signal or an edge at which alarm output changes from cancellation to generation ↓L : Detects a falling edge of an analog signal or an edge at which alarm output changes from generation to cancellation.
Level	Sets a voltage level to be searched for when the search channel is an analog or pulse channel.

### (9)-7 Find Next

Executing this option moves the cursor to a next position where the search conditions are met, down from the current cursor position. (Specify the search conditions as described in (9)-6 "Data Search.")

### (9)-8 Find Previous

Executing this option moves the cursor to a previous position where the search conditions are met, up from the current cursor position. (Specify the search conditions as described in (9)-6 "Data Search.")

**(9)-9 Execute (Calculation)**

Executes calculation between cursors. Executing this option opens a window to display calculation results. For description of the calculation results, see the table below. Pressing the FILE key opens a window for saving statistical calculation results. Specify a save destination and select OK to save statistical calculation results in text (CSV) format.

\* A save destination and a file name can be specified in the same way as for specifying a file for captured data. Refer to (7) "File Box" (page 3-41).

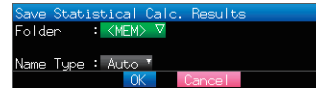
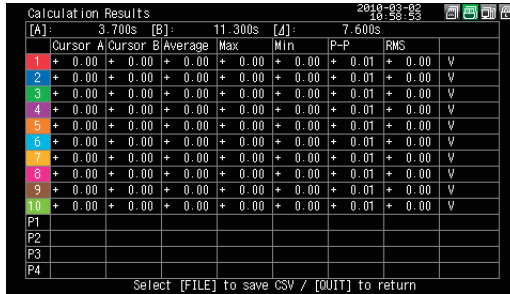

Selection item	Description
Average	Displays the simple average value of the data during data capture.
Max	Displays the maximum value of the data during data capture.
Min	Displays the minimum value of the data during data capture.
Peak	Displays the peak value of the data during data capture.
RMS	Displays the RMS value of the data during data capture. The calculation formula is as follows: $R.M.S = \sqrt{\Sigma D^2/n}$ * D: data n: number of data

**(10) Quick settings**

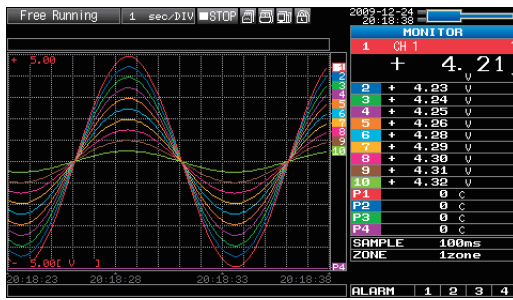

Screen	Operation mode	Content	Explanation
Waveform	Free Running	SAMPLE	< > key can be used to change the sampling interval.
		ZONE	< > key can be used to change the zone division.
	Recording	ZONE	< > key can be used to change the zone division.
	Dual View Replaying	ZONE	< > key can be used to change the zone division.
	Replaying	SERCH	< > key can be used to perform search. < :Searches past side >  :Searches future side
		ZONE	< > key can be used to change the zone division.

**(11) To cancel key lock by password**

A password can be set to GL220 to cancel the key lock.  
(No password is set at factory default.)

<Operation flow>

1. Set the password.



Press the <, >, and ENTER keys at the same time to display the password setting screen shown below. Specify a 4 digit password.

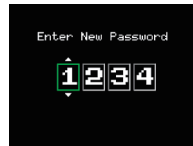

Use the <, >, Δ, ∇ keys to select numbers. Press the ENTER key to confirm the password.

Specifying 0000 will disable password operation.

In case you forgot your password, please contact us to acquire the master password.

2. Set the password.

Hold down the << and >> keys together for at least two seconds.

3. Cancel the key lock.

Hold down the << and >> keys together again for at least two seconds.

The password setting screen shown below will be displayed. Set a password.

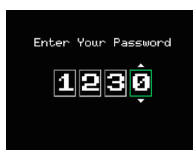

Entering an incorrect password will not cancel key lock.

Key lock state will be retained when power is turned off.





# CHAPTER 4 Specification

---

This chapter describes the basic specifications for the GL220.

- 4.1 Standard Specifications
- 4.2 Function Specifications
- 4.3 Accessory/Option Specifications
- 4.4 External Dimensions

## 4.1 Standard Specifications

### Standard Specifications

Item	Description				
Number of analog channel	10 channels				
External input/output	Trigger input or external sampling pulse/logic input 4 channels or pulse input 4 channels, alarm output 4 channels				
PC interface	USB (Full speed) standard				
Internal memory device	Approx. 2 GB internal memory USB memory slot (Full speed supported) standard				
Data backup functions	Setup conditions: EEPROM; Clock: Lithium battery				
Clock accuracy (ambient temperature 23°C)	± 0.002% (approx. 50 seconds per month)				
Operating environment	0 to 45°C, 5 to 85%RH (0 to 40°C when operated in batteries/15 to 35°C when battery is charging)				
Withstand voltage	Between each input channel and GND: 1 minute at 350 Vp-p Between each input channels: 1 minute at 350 Vp-p				
Power supply	AC adapter: 100 to 240 VAC, 50/60 Hz DC input: 8.5 to 24 VDC (max. 26.4 V) Battery pack (option): 7.4 VDC (2200 mAh)				
Power consumption	AC power consumption (when the supplied AC adapter is used)				
	No.	Condition	Normal consumption	During recharging battery	
	1	When the LCD is ON	12VA	29VA	
	2	When the screensaver is operating	11VA	28VA	
	DC power consumption				
	No	DC voltage	Condition	Normal consumption	During recharging battery
	1	+24V	When the LCD is ON	0.18A	0.6VA
	2	+24V	When the screensaver is operating	0.15A	0.57VA
	3	+12V	When the LCD is ON	0.31A	Recharging battery is not possible.
	4	+12V	When the screensaver is operating	0.26A	Recharging battery is not possible.
5	+8.5V	When the LCD is ON	0.45A	Recharging battery is not possible.	
6	+8.5V	When the screensaver is operating	0.37A	Recharging battery is not possible.	
* Normal condition: LCD brightness is set to MAX.					
External dimensions	194×117×42 mm				
Weight*1	520g				
Vibration-tested conditions	Equivalent to automobile parts Type 1 Category A classification				

\*1 Excluding the AC adapter and battery

### Internal memory devices

Item	Description
Memory capacity	Internal memory : Approx. 2GB Flash Memory USB memory : Unlimited (However, one file must be 2GB at the maximum.)
Memory contents	<ul style="list-style-type: none"> <li>• Setup conditions</li> <li>• Measured data</li> <li>• Screen copy</li> </ul>

### PC Interface

Item	Description
Interface types	USB (Full speed)
Functions	<ul style="list-style-type: none"> <li>• Data transfer to the PC (realtime, memory)</li> <li>• PC control of the GL220</li> </ul>
USB functions	USB drive mode: Transfers and deletes file from internal memory
Realtime data transfer speed	10 ms/1ch maximum

### Monitor

Item	Description
Display	4.3-inch TFT color LCD (WQVGA: 480 x 272 dots)
Displayed languages	English, French, Japanese, German, Chinese, Korean
Backlight life	20000 hr (when brightness is down to 50%), depends on operation environment
Backlight	Screen saver function provided (10, 30 s, 1, 2, 5, 10, 30, 60 min.)

## Input Unit Specifications

Item	Description																														
Number of input channels	10 channels																														
Input terminal type	M3 screw type terminal																														
Input method	Photo MOS relay scanning system All channels isolated, balanced input																														
Scan speed	10 ms/1 ch maximum																														
Measurement ranges	Voltage: 20, 50, 100, 200, 500 mV; 1, 2, 5, 10, 20, 50 V; 1-5 V F.S. Temperature • Thermocouples: K, J, E, T, R, S, B, N, W (WRe5-26) Humidity: 0 to 100% (voltage 0 V to 1 V scaling conversion) *with B-530 (option)																														
Measurement accuracy (23°C ±5°C) when 30 minutes or more have elapsed after the power is turned on • Filter ON (10) • Sampling 1s (10CH) • GND connected	Voltage: 0.1% of F.S. Temperature <table border="1"> <thead> <tr> <th>Thermocouple</th> <th>Measurement Temperature Range (°C)</th> <th>Measurement Accuracy</th> </tr> </thead> <tbody> <tr> <td>R/S</td> <td>0 ≤ TS ≤100 100 &lt; TS ≤300 R : 300 &lt; TS ≤1600°C S : 300 &lt; TS ≤1760°C</td> <td>±5.2°C ±3.0°C ±(0.05% of rdg +2.0°C) ±(0.05% of rdg +2.0°C)</td> </tr> <tr> <td>B</td> <td>400 ≤ TS ≤600 600 &lt; TS ≤1820°C</td> <td>±3.5°C ±(0.05% of rdg +2.0°C)</td> </tr> <tr> <td>K</td> <td>-200 ≤ TS ≤-100 -100 &lt; TS ≤1370°C</td> <td>±(0.05% of rdg +2.0°C) ±(0.05% of rdg +1.0°C)</td> </tr> <tr> <td>E</td> <td>-200 ≤ TS ≤-100 -100 &lt; TS ≤800°C</td> <td>±(0.05% of rdg +2.0°C) ±(0.05% of rdg +1.0°C)</td> </tr> <tr> <td>T</td> <td>-200 ≤ TS ≤-100 -100 &lt; TS ≤400°C</td> <td>±(0.1% of rdg +1.5°C) ±(0.1% of rdg +0.5°C)</td> </tr> <tr> <td>J</td> <td>-200 ≤ TS ≤-100 -100 &lt; TS ≤100 100 &lt; TS ≤1100°C</td> <td>±2.7°C ±1.7°C ±(0.05% of rdg +1.0°C)</td> </tr> <tr> <td>N</td> <td>0 ≤ TS ≤1300°C</td> <td>±(0.1% of rdg +1.0°C)</td> </tr> <tr> <td>W</td> <td>0 ≤ TS ≤2000°C</td> <td>±(0.1% of rdg +1.5°C)</td> </tr> <tr> <td colspan="2">Reference contact compensation accuracy</td> <td>±0.5°C</td> </tr> </tbody> </table> <p>* Thermocouple diameters T: 0.32 φ, others: 0.65 φ</p>	Thermocouple	Measurement Temperature Range (°C)	Measurement Accuracy	R/S	0 ≤ TS ≤100 100 < TS ≤300 R : 300 < TS ≤1600°C S : 300 < TS ≤1760°C	±5.2°C ±3.0°C ±(0.05% of rdg +2.0°C) ±(0.05% of rdg +2.0°C)	B	400 ≤ TS ≤600 600 < TS ≤1820°C	±3.5°C ±(0.05% of rdg +2.0°C)	K	-200 ≤ TS ≤-100 -100 < TS ≤1370°C	±(0.05% of rdg +2.0°C) ±(0.05% of rdg +1.0°C)	E	-200 ≤ TS ≤-100 -100 < TS ≤800°C	±(0.05% of rdg +2.0°C) ±(0.05% of rdg +1.0°C)	T	-200 ≤ TS ≤-100 -100 < TS ≤400°C	±(0.1% of rdg +1.5°C) ±(0.1% of rdg +0.5°C)	J	-200 ≤ TS ≤-100 -100 < TS ≤100 100 < TS ≤1100°C	±2.7°C ±1.7°C ±(0.05% of rdg +1.0°C)	N	0 ≤ TS ≤1300°C	±(0.1% of rdg +1.0°C)	W	0 ≤ TS ≤2000°C	±(0.1% of rdg +1.5°C)	Reference contact compensation accuracy		±0.5°C
Thermocouple	Measurement Temperature Range (°C)	Measurement Accuracy																													
R/S	0 ≤ TS ≤100 100 < TS ≤300 R : 300 < TS ≤1600°C S : 300 < TS ≤1760°C	±5.2°C ±3.0°C ±(0.05% of rdg +2.0°C) ±(0.05% of rdg +2.0°C)																													
B	400 ≤ TS ≤600 600 < TS ≤1820°C	±3.5°C ±(0.05% of rdg +2.0°C)																													
K	-200 ≤ TS ≤-100 -100 < TS ≤1370°C	±(0.05% of rdg +2.0°C) ±(0.05% of rdg +1.0°C)																													
E	-200 ≤ TS ≤-100 -100 < TS ≤800°C	±(0.05% of rdg +2.0°C) ±(0.05% of rdg +1.0°C)																													
T	-200 ≤ TS ≤-100 -100 < TS ≤400°C	±(0.1% of rdg +1.5°C) ±(0.1% of rdg +0.5°C)																													
J	-200 ≤ TS ≤-100 -100 < TS ≤100 100 < TS ≤1100°C	±2.7°C ±1.7°C ±(0.05% of rdg +1.0°C)																													
N	0 ≤ TS ≤1300°C	±(0.1% of rdg +1.0°C)																													
W	0 ≤ TS ≤2000°C	±(0.1% of rdg +1.5°C)																													
Reference contact compensation accuracy		±0.5°C																													
Reference contact compensation accuracy	Internal/External switching																														
A/D converter	Method : $\Delta\Sigma$ method Resolution : 16-bit (Effective resolution: About 1/40,000 of the +/- range)																														
Temperature coefficient	Gain : 0.01% of F.S./°C Zero : 0.02% of F.S./°C * Occurs when sampling speed is 10, 20, or 50 ms.																														
Input resistance	1 M $\Omega$ ±5%																														
Allowable signal source resistance	Within 300 $\Omega$																														
Maximum permissible input voltage	Between +/- input terminals :60 Vp-p Between input terminal/input terminal :60 Vp-p Between input terminal/GND :60 Vp-p																														
Withstand voltage	Between input terminal/input terminal :1 minute at 350 Vp-p Between input terminal/GND :1 minute at 350 Vp-p																														
Insulation resistance	Between input terminal/GND: At least 50 M $\Omega$ (at 500 VDC)																														
Common mode rejection ratio	At least 90 dB (50/60 Hz; signal source 300 $\Omega$ or less)																														
Noise	At least 48 dB (with +/- terminals shorted)																														
Filter	Off, 2, 5, 10, 20, 40 Filter operation is on a moving average basis. The average value of the set sampling count is used. If the sample interval exceeds 5 seconds, the average value of data obtained in a sub-sample (5 seconds) is used.																														

## 4.2 Function Specifications

### Function Specifications

Item	Description
Display screen	Waveform + Digital screen, All Waveform screen, Digital + Calculation Display screen, Expanded digital screen * Can be switched using the dedicated key (toggle operation). * For the Expanded Digital screen, the number of channels and the display channel must be specified.
Sampling interval	10, 20, 50, 100, 125, 200, 250, 500 ms; 1, 2, 5, 10, 20, 30 s; 1, 2, 5, 10, 20, 30 min; 1 h, External * 50 ms and below can be selected according to input settings and number of measured channels.
Waveform expansion / contraction	Time axis: 1, 2, 5, 10, 20, 30 sec/Div 1, 2, 5, 10, 20, 30 min/Div 1, 2, 5, 10, 12, 24 h/Div Voltage axis: variable span
Scaling function	4 points can be set for each channel • The temperature range scaling function is available.
Functions during capture	<ul style="list-style-type: none"> <li>• Double-screen display</li> <li>• Exchange of USB memory</li> <li>• Saving of data between cursors</li> </ul>
Data save functions	Capture to internal memory Capture to USB memory The setup data can be saved (Main or USB memory) Copy of data screen can be saved (Main or USB memory)
Ring capture	Function : ON, OFF Number of recording points : 1000 to 2000000 * When ring capture is ON, the memory space that can be used for capture is one-third of the free space or less.
Calculation between Channels	Calculation type : Addition, subtraction, multiplication, and division Input target : Analog channels 1 through 10
Statistical calculation	Types of operation : Average value, peak value, maximum value, minimum value, RMS Number of operations : maximum of 2 can be set simultaneously Calculation method : Realtime calculation and calculation between cursors (during replay) * Realtime calculation results are displayed in the Digital + Calculation Display screen.
Search functions	Function: Search the captured data for the required number of points Search type: Channel Pulse, Logic, Level, Alarm search
Annotation input function	Function: A comment can be input for each channel Inputtable characters: Alphanumerics Number of characters: 31 * Displayed up to 18 characters in the Waveform + Digital screen or 14 characters in the Digital + Calculation Display screen

### Trigger Functions

Item	Description
Repeat Trigger	Off, On
Trigger types	Start : Data capture starts when a trigger is generated. Stop : Data capture stops when a trigger is generated.
Trigger conditions	Start : Off, Level, Alarm, External, Time, Date, Weekly Stop : Off, Level, Alarm, External, Time, Date, Weekly
Level trigger judgment modes	Combination : Level OR, Level AND, Edge OR, Edge AND Analog channel judgment mode : H (↑), L (↓), Window In, Window Out Logic channel judgment mode : H (↑), L (↓) Pulse channel judgment mode : H (↑), L (↓), Window In, Window Out
Alarm judgment modes	Detection method : Level, Edge Analog channel judgment mode : H (↑), L (↓), Window In, Window Out Logic channel judgment mode : H (↑), L (↓) Pulse channel judgment mode : H (↑), L (↓), Window In, Window Out



## 4.3 Accessory/Option Specifications

### Control Software

Item	Description
Compatible operating system	Windows XP/Vista/Windows 7
Functions	Main unit control, realtime data capture, data conversion, data replay
Main unit settings	AMP settings, Data Capture settings, Trigger Alarm settings, Report settings, Other settings
Captured data	Realtime data (CSV, Binary) Internal memory (CSV, Binary) USB memory (CSV, Binary)
Display	Analog waveforms, logic waveforms, pulse waveforms, digital values
Display modes	Y-T View, Digital View, Report View, X-Y View between Cursors (only during replay)
File conversion	Between cursors, All data, Thinning function
Monitor functions	Alarm monitor enables sending of email to the specified address
Report function	Automatic creation of daily or monthly files
Maximum/Minimum	The maximum, minimum and current values are displayed during measurement

### Accessories

Item	Remarks	Quantity
Quick Start Guide	GL220-UM-8 xx	1
CD-ROM	GL220-CDM 0 x M (User's Manual, Application software)	1
AC adapter	100 to 240 VAC, 50/60 Hz, one set of region-specific power cables	1

### Battery Pack B-517 (Option)

Item	Description
Capacity	7.4V/2200mAh 17Wh
Running time	When using the LCD display: approx. 5 hours When using the screensaver: approx. 6 hours Note: When capturing to internal memory at 1 s, sampling, using new battery packs at +25°C environment. Note: The running time depends on such as the operating environment, the amount of charge left in the battery and connecting USB memory.
Battery type	Lithium secondary battery
Charging method	Mount in the main unit, or use a separate battery charger
Time required for charging	Main unit: approx. 4 hours
Switchover in the case of a power failure	Because the battery is used together with the AC adapter, the power supply will be switched automatically to the battery in the event of a power failure. Note: The AC adapter is the primary power source.
Operation environment	Running on battery: 0 to 40°C, Battery being charged: 15 to 35°C
Other functions	When the battery is running low, measured data is saved and the file is closed automatically (during internal memory and USB memory capture). The remaining battery power is displayed.

### Humidity Sensor B-530 (Option)

Item	Description																		
Allowable temperature range	-25 to +80°C																		
Allowable humidity range	0 to 100% RH																		
Relative humidity measurement accuracy	±3% RH (5 to 98% RH at 25°C)																		
Method	Capacitance method																		
Relative humidity measurement accuracy (5~98%)	<table border="1"> <thead> <tr> <th>Measurement environment</th> <th>Measurement accuracy</th> </tr> </thead> <tbody> <tr> <td>0~10°C</td> <td>±5% RH</td> </tr> <tr> <td>10~20°C</td> <td>±4% RH</td> </tr> <tr> <td>20~30°C</td> <td>±3% RH</td> </tr> <tr> <td>30~40°C</td> <td>±4% RH</td> </tr> <tr> <td>40~50°C</td> <td>±5% RH</td> </tr> <tr> <td>50~60°C</td> <td>±6% RH</td> </tr> <tr> <td>60~70°C</td> <td>±7% RH</td> </tr> <tr> <td>70~80°C</td> <td>±8% RH</td> </tr> </tbody> </table>	Measurement environment	Measurement accuracy	0~10°C	±5% RH	10~20°C	±4% RH	20~30°C	±3% RH	30~40°C	±4% RH	40~50°C	±5% RH	50~60°C	±6% RH	60~70°C	±7% RH	70~80°C	±8% RH
	Measurement environment	Measurement accuracy																	
	0~10°C	±5% RH																	
	10~20°C	±4% RH																	
	20~30°C	±3% RH																	
	30~40°C	±4% RH																	
	40~50°C	±5% RH																	
	50~60°C	±6% RH																	
	60~70°C	±7% RH																	
70~80°C	±8% RH																		
Response time	15 s (90% response when membrane filter installed)																		
Sensor output	0 to 1 VDC																		
Sensor power	+5 to +16 VDC																		
Consumption current	+Approx. 4 mA																		
External dimensions	φ14 mm x 80 mm (excluding cable)																		
Cable length	3 m																		

### List of Options

Item	Option No.	Remarks
Logic alarm cable	B-513	2m, Bare tips
DC drive cable	B-514	2m, Bare tips
Battery pack	B-517	7.4V/2200mAh 17Wh
Humidity sensor *1	B-530	3 m, with dedicated power connector
Humidity sensor power box	B-542	For connection with 10 humidity sensors: Built to order
M3 screws with flat washers (60)	B-543	60 per set
USB memory 2GB	B-550	2GB
Shunt resistor 250 Ω	B-551	250 Ω, Rated power of 1 W, Maximum service voltage of 15.8 V, Built to order
T-type thermocouple *2	JSB-7115-5M-T	5-m length, 5 thermocouples per set, wire diameter of 0.32, 1.0 x 1.6 x 5000 mm
K-type thermocouple *2	JSB-7115-5M-K	5-m length, 5 thermocouples per set, wire diameter of 0.32, 1.0 x 1.6 x 5000 mm
Extra fine K-type thermocouple (TC200/TD1000), 5 per set	ST-55K-TC-1.2M	Tip wire diameter of 0.127, 0.5 x 0.7 x 200 mm, Relay part 1 m, 5 per set
Needle-shape K-type thermocouple	RIC-410	-100 to 300°C, Class 1, Cord length: 1.1 m
Stationery-surface K-type thermocouple	RIC-420	-30 to 400°C, Class 2, Cord length: 1.1 m
L-type stationery-surface K-type thermocouple	RIC-430	-30 to 600°C, Class 2, Cord length: 1.1 m
Mini-connector for K-type thermocouple (5 per set)	RIC-440	5 per set, Connectable thermocouple: Wire diameter of 0.65 mm, End terminal: M3Y terminal
Mini-connector for K-type thermocouple (2 per set)	RIC-441	2 per set, Connectable thermocouple: Wire diameter of 0.65 mm, End terminal: M3Y terminal
Mini-connector for T-type thermocouple (5 per set)	RIC-450	5 per set, Connectable thermocouple: Wire diameter of 0.65 mm, End terminal: M3Y terminal
Mini-connector for T-type thermocouple (2 per set)	RIC-451	2 per set, Connectable thermocouple: Wire diameter of 0.65 mm, End terminal: M3Y terminal

\*1: Allowable temperature range: -25 to +80°C

\*2: Sold only in Japan



## 4.4 External Dimensions

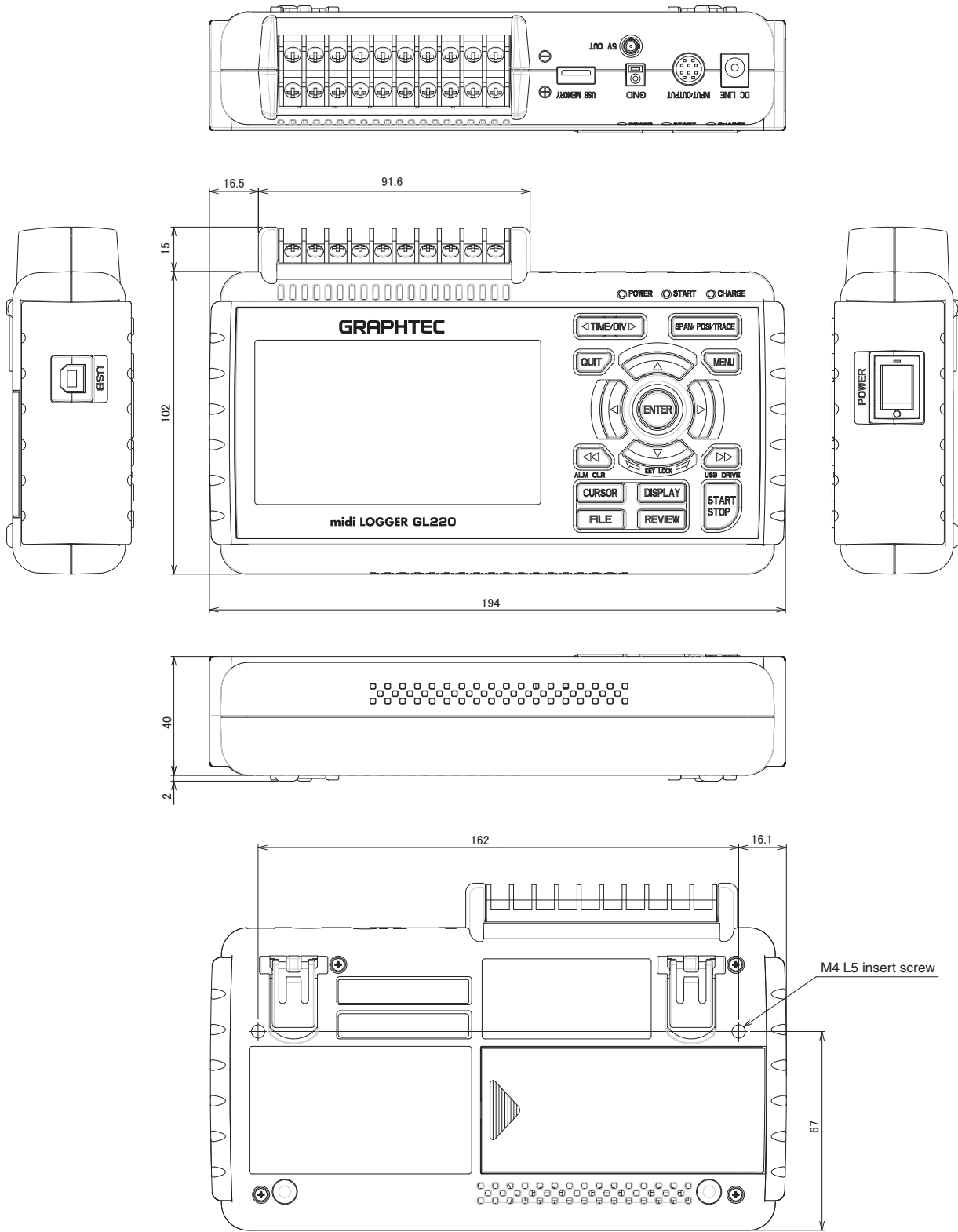

Dimension precision: Error  $\pm$  5 mm  
Unit: mm



# Index

- A**
- AC line filter ..... 3-26
  - AC Line Frequency ..... 3-35
  - AC Power Supply ..... 2-4
  - AC/battery display ..... 3-4
  - Accessories ..... 2-2, 4-7
  - A/D resolution ..... 2-6, 4-4
  - ALARM CLEAR ..... 3-11
  - Alarm display area ..... 3-4
  - Alarm Hold ..... 3-29
  - Alarm level setting ..... 3-29, 3-30
  - Alarm Output ..... 2-7
  - AMP setting ..... 3-16
  - Amplitude setting ..... 3-20, 3-22
  - Analog Input circuit diagram ..... 2-15
  - Analog settings ..... 3-17
  - Annotation ..... 3-20
- B**
- Background Color ..... 3-35
  - Backup setting ..... 3-27
  - Base Procedures Used in Settings ..... 3-12
  - Battery
    - Charging ..... 2-13
    - Mounting ..... 2-12
  - Battery Pack Specifications ..... 4-7
  - Bitmap file format ..... 3-39
  - Burn Out ..... 3-29, 3-35
- C**
- Calculation between cursor ..... 3-46
  - Captured data file name ..... 3-23, 3-24
  - Capturing ..... 3-14, 3-15
  - Clock display area ..... 3-4
  - Connecting to a PC ..... 2-11
  - Connection Diagram ..... 2-6
  - Control Software ..... 4-7
  - CURSOR key ..... 3-11
  - Cursor Position ..... 3-44
  - Cursor Sync ..... 3-45
- D**
- Data Capture bar ..... 3-6
  - Data replay menu ..... 3-44
  - Data Save ..... 3-37
  - DATA settings ..... 3-23
  - Data Search ..... 3-44, 3-45
  - Data and Time ..... 3-35
    - setting ..... 2-17
  - DC Power Supply ..... 2-5
  - Dead zones of trigger and alarm levels ..... 3-32
  - Demo Waveform Mode ..... 3-36
  - Department name ..... 3-33
  - Digital Display area ..... 3-4
  - Direction keys ..... 3-8
  - DISPLAY key ..... 3-10
  - Dual View Replaying ..... 3-13, 3-14
- E**
- Edge operations ..... 3-31
  - ENTER key ..... 3-8
  - EU ..... 3-19, 3-22
  - Execute (Calculation) ..... 3-46
  - External Dimensions ..... 4-9
  - External Input/Output Functions Specifications ..... 4-6
  - External Sampling ..... 3-26
- F**
- FAST FORWARD key ..... 3-9
  - File box ..... 3-41
  - File key ..... 3-11
  - File menu ..... 3-37
  - File name display area ..... 3-5
  - File Operation ..... 3-37
  - Filter ..... 2-6, 3-18, 3-21
  - Find Next ..... 3-45
  - Find Previous ..... 3-45
  - Free Running ..... 3-13
  - Function Specifications ..... 4-5
- G**
- Guest ..... 3-32
- H**
- Humidity sensor ..... 2-14, 4-8
- I**
- I/F Specifications ..... 4-3
  - Information ..... 3-36
  - Input ..... 3-17, 3-21
    - Specifications ..... 4-4
  - Internal Memory
    - access display area ..... 3-3
    - device specifications ..... 4-3
  - Inter-CH Op setting ..... 3-16, 3-20
- K**
- KEY LOCK ..... 3-9
  - Key lock display area ..... 3-3
  - Key Operation ..... 3-7
- L**
- Language ..... 1-4, 3-35
  - LCD brightness ..... 3-34
  - Level operations ..... 3-31
  - List Of Options ..... 2-2, 4-8
  - Load (setting conditions) ..... 3-40
  - LOCAL ..... 3-8
  - Logic and Pulse setting ..... 3-21
  - Logic/Pulse ..... 3-16

- Lower limit scale ..... 3-5  
 Logic Alarm Cable ..... 2-7  
   Internal equivalent circuit of I/O ..... 2-8
- M**  
 Macro ..... 3-33  
 Maximum input voltage ..... 2-15  
 MENU key ..... 3-8  
 Monitor Specifications ..... 4-3  
 Move to Center ..... 3-44  
 Move to First Data ..... 3-44  
 Move to Last Data ..... 3-44  
 Move to Selected Position ..... 3-45
- N**  
 Noise Countermeasures ..... 2-16
- O**  
 Operating Environment ..... 1-3  
 OTHR setting ..... 3-34
- P**  
 PC Interface Specification ..... 4-3  
 Pen display ..... 3-4  
 Ping format ..... 3-39  
 Power On Start ..... 3-34
- Q**  
 Quick settings ..... 3-4, 3-47  
 QUIT key ..... 3-8
- R**  
 Range ..... 3-17  
 Remote display area ..... 3-3  
 Repeated capturing ..... 3-29  
 Replaying ..... 3-13, 3-15  
 Resistance temperature detector ..... 2-6  
 Return to default setting ..... 3-36  
 REVIEW key ..... 3-10  
 Ring capture setting ..... 3-25  
 Room Temp Compensation ..... 3-35
- S**  
 Sampling Interval ..... 3-23  
 Save (setting conditions) ..... 3-40  
 Scaling settings ..... 3-19, 3-22  
 Screen Copy ..... 3-39  
 Screen Saver ..... 3-34  
 Setting Menus ..... 3-16  
 Simplified message display area ..... 3-2  
 Slope ..... 3-21  
 Span ..... 3-16, 3-20  
 SPAN/POSITION/TRACE key ..... 3-7  
 Specify Save Destination ..... 3-39  
 Standard Specifications ..... 4-2  
 Start side source setting ..... 3-28  
 START/STOP key ..... 3-9  
 Statistical calculation setting ..... 3-27
- Status mark area ..... 3-3  
 Stop side source setting ..... 3-29
- T**  
 Temp Unit ..... 3-35  
 Temperature setting ..... 3-35  
 Text input ..... 3-43  
 TIME/DIV display area ..... 3-3  
 TIME/DIV key ..... 3-8  
 Thermocouple ..... 2-6  
 TRIG setting ..... 3-28  
 Trigger and Alarm operations ..... 3-31  
 Trigger Functions Specifications ..... 4-5  
 Trigger level settings ..... 3-30  
 Time Stamp ..... 3-5  
 To cancel key lock by password ..... 3-47
- U**  
 Upper limit scale ..... 3-5  
 USB Connection ..... 2-11  
 USB Drive Mode ..... 3-9  
 USB ID ..... 3-35  
 USB Memory  
   Attaching ..... 2-10  
   access display area ..... 3-3  
   Remove/Exchange ..... 3-38  
 User ..... 3-32  
 USER settings ..... 3-32
- W**  
 Warming-up ..... 1-3  
 Waveform color setting ..... 3-20, 3-22  
 Waveform display area ..... 3-5  
 Window names and functions ..... 3-2
- Z**  
 Zero Adjustment ..... 3-20  
 Zero position voltage value ..... 3-20

• The specifications, etc., in this manual are subject to change without notice.

GL220-UM-151

April 1, 2010  
1st edition-01

GRAPHTEC CORPORATION

## **GRAPHTEC CORPORATION**

503-10 Shinano-cho, Totsuka-ku,  
Yokohama 244-8503, Japan

Tel: +81 (045) 825-6250

Fax : +81 (045) 825-6396

Email : [info@graphteccorp.com](mailto:info@graphteccorp.com)

Web: [www.graphteccorp.com](http://www.graphteccorp.com)

Printed in Japan